



design award  
winner  
**2004**

Front dimensions: 30 x 30 mm  
Panel cut-out: Ø 22.3 mm  
Front bezel height: 12 mm  
Travel: 6 mm



QUARTEX-R





- 01 Pushbutton Heads page 262
- 02 Emergency Stop Buttons page 265
- 03 Mushroom Heads page 265
- 04 Knob Set for Rotary Switch / Potentiometer page 267
- 05 Selector Heads page 267
- 06 Toggle Heads page 269

- 07 Key Actuators page 270
- 08 Pilot Lights page 272

**Contact Blocks / Lampholders** page 414



 degree of protection

 illuminating option

 operating travel

 labelling option

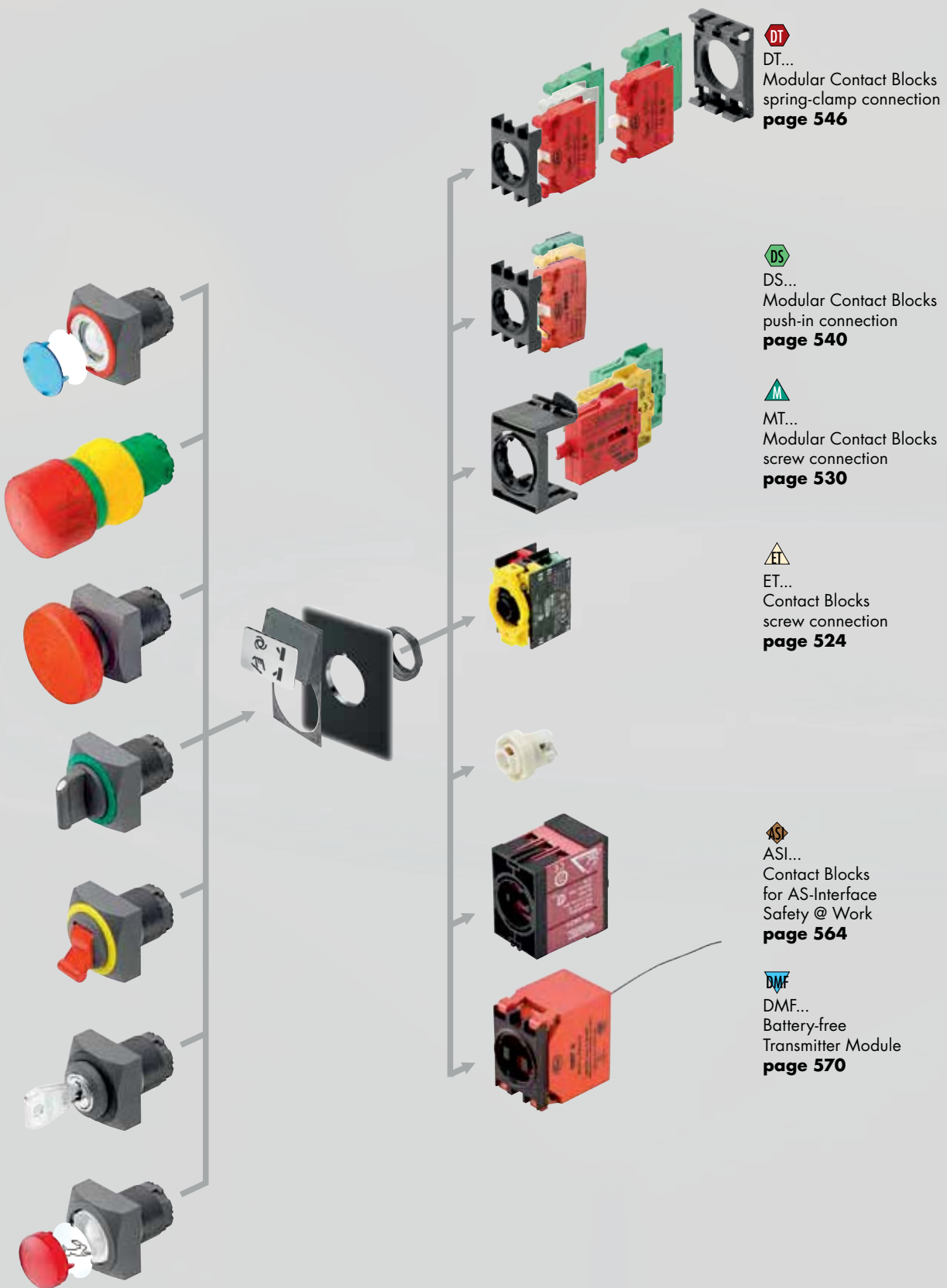

**DT**  
DT...  
Modular Contact Blocks  
spring-clamp connection  
**page 546**

**DS**  
DS...  
Modular Contact Blocks  
push-in connection  
**page 540**

**MT**  
MT...  
Modular Contact Blocks  
screw connection  
**page 530**

**ET**  
ET...  
Contact Blocks  
screw connection  
**page 524**

**AS**  
ASI...  
Contact Blocks  
for AS-Interface  
Safety @ Work  
**page 564**

**DMF**  
DMF...  
Battery-free  
Transmitter Module  
**page 570**

**When combining the DT... contact blocks with key, selector and toggle heads,  
please add ...\_497 to the actuator type reference!**

## Mounting Depth Dimensions

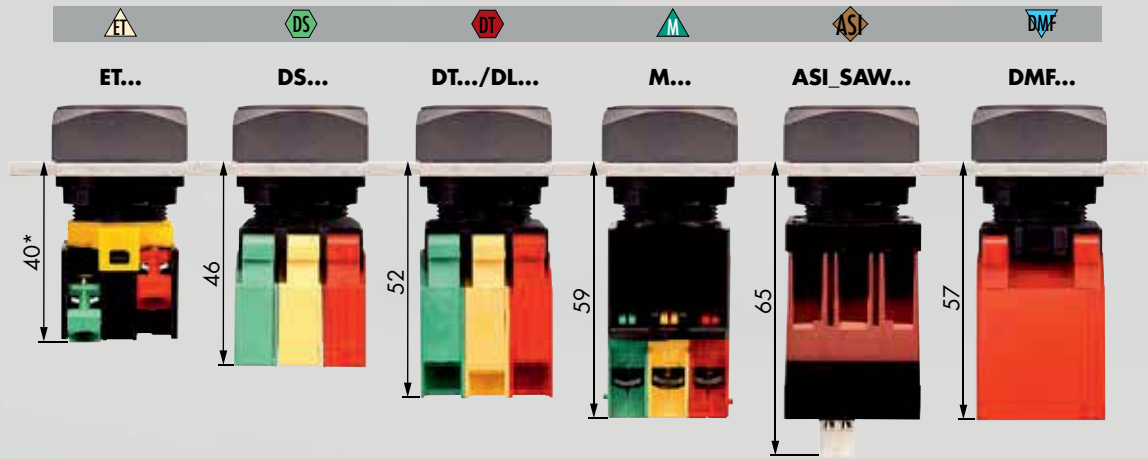

\* ETR2 61mm, ETLR 50mm, ETLR2 70mm, EL9R 36mm

## Cutout Dimensions

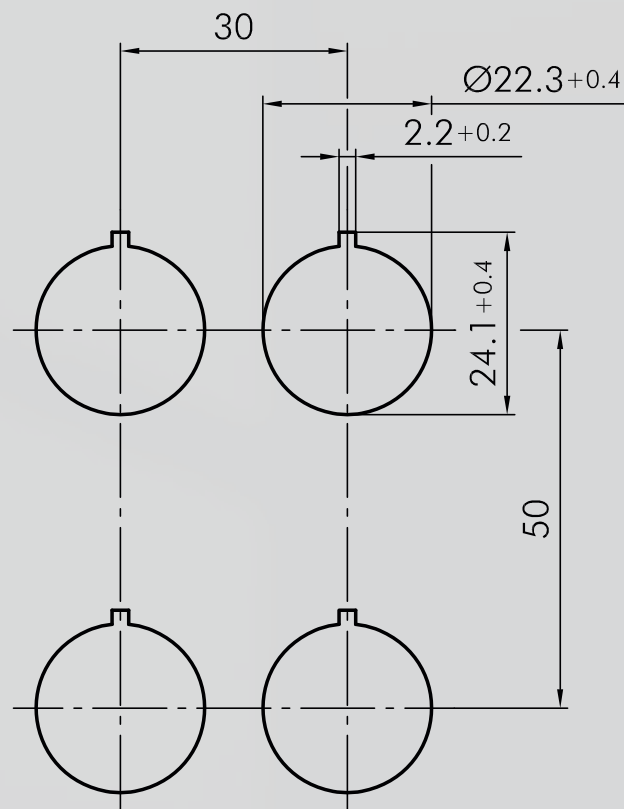

## Mounting and Service Instructions

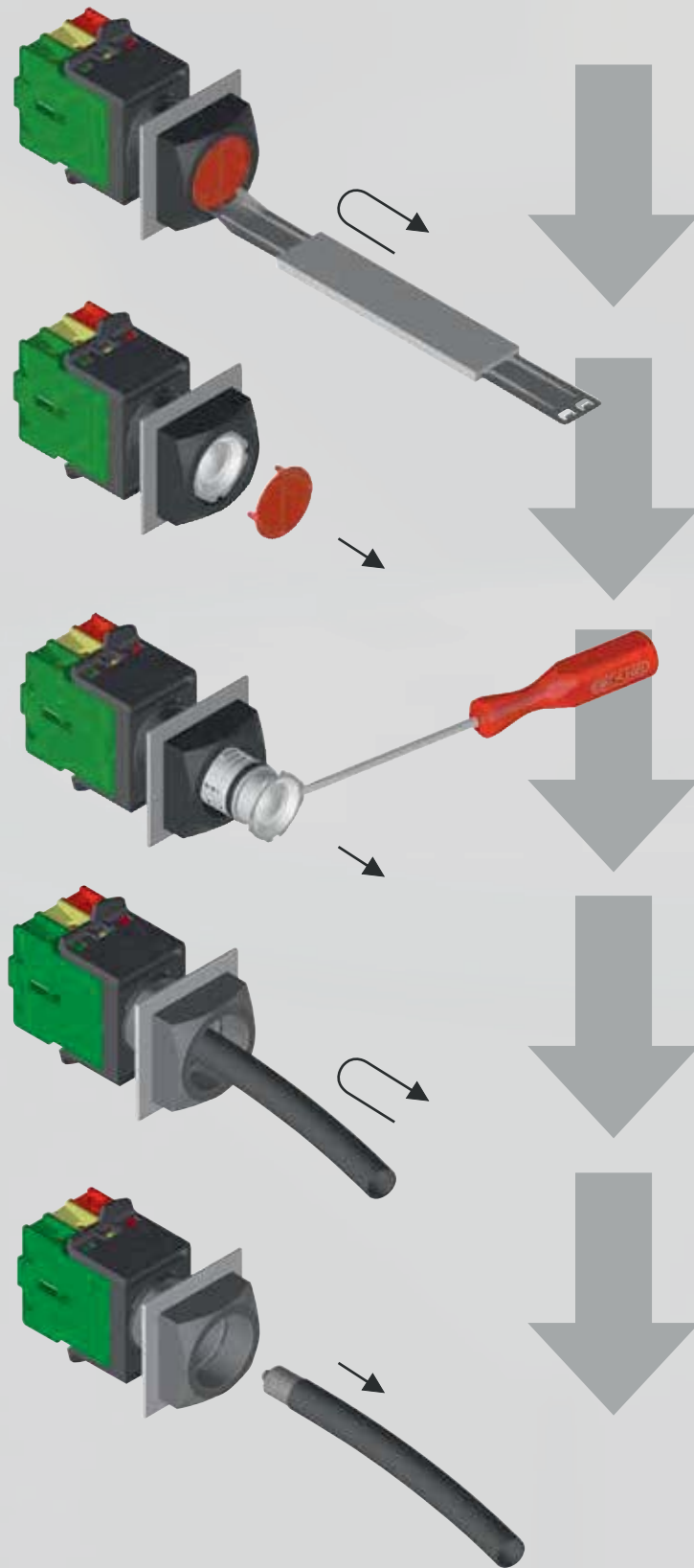

## Pushbutton Heads (momentary/push-push)

Front rings are supplied in dark-grey as a standard (QRT), also available in blue-BL, yellow-GB, green-GN, red-RT, white-WS and black-SW.

Add code letter to type number (e.g. QRT\_RRT)

Lenses and nameplates to be ordered separately

Illustration

Dimensions

Description

Type

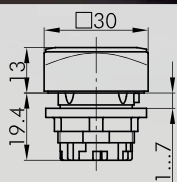

### Pushbutton Head

suitable contact blocks



front bezel

charcoal

**QRT...**



### Concave Lens, transparent

colour

blue

**T26DBL**

yellow

**T26DGB**

green

**T26DGN**

clear

**T26DKL**

opalwhite

**T26DWS**



### Concave Lens, non-transparent

used in pushbuttons without inscription and illumination

colour

blue

**T26DGBL**

yellow

**T26DGGB**

green

**T26DGGN**

black

**T26DGSW**

red

**T26DGRT**

white

**T26DGWS**



### High Lens, transparent

colour

blue

**KH23BL**

yellow

**KH23GB**

green

**KH23GN**

clear

**KH23KL**

red

**KH23RT**

opalwhite

**KH23WS**



### High Lens, non-transparent

used in pushbuttons without inscription and illumination

colour

blue

**TG22GHBL**

yellow

**TG22HGGB**

green

**TG22GHGN**

black

**TG22GHSW**

red

**TG22GHRT**

white

**TG22GHWS**

**Pushbutton Heads (momentary/push-push)**

Front rings are supplied in dark-grey as a standard (QRTM), also available in blue-BL, yellow-GB, green-GN, red-RT, white-WS and black-SW.

Add code letter to type number (e.g. QRTM\_RRT)

Illustration	Dimensions	Description	Type												
		<b>Nameplate</b> with standard imprint, please specify index number (see nameplates on pages 410)	<b>BSK...</b>												
		<b>Nameplate</b> with special imprint according to customer's specifications	<b>BSKB</b>												
		<b>Blank Nameplate</b>	<b>BSKU</b>												
  		<b>Membrane Pushbutton Head</b> with tightly closed, transparent silicone cap, down to -50° C  suitable contact blocks  front bezel charcoal	<b>QRTM...</b>												
		<b>Flat Lens, transparent</b> colour <table border="0" style="display: inline-table; vertical-align: top;"> <tr><td>blue</td><td><b>T20FBL</b></td></tr> <tr><td>yellow</td><td><b>T20FGB</b></td></tr> <tr><td>green</td><td><b>T20FGN</b></td></tr> <tr><td>clear</td><td><b>T20FKL</b></td></tr> <tr><td>red</td><td><b>T20FRT</b></td></tr> <tr><td>opalwhite</td><td><b>T20FWS</b></td></tr> </table>	blue	<b>T20FBL</b>	yellow	<b>T20FGB</b>	green	<b>T20FGN</b>	clear	<b>T20FKL</b>	red	<b>T20FRT</b>	opalwhite	<b>T20FWS</b>	
blue	<b>T20FBL</b>														
yellow	<b>T20FGB</b>														
green	<b>T20FGN</b>														
clear	<b>T20FKL</b>														
red	<b>T20FRT</b>														
opalwhite	<b>T20FWS</b>														
		<b>Nameplate</b> with standard imprint, please specify index number (see nameplates on pages 410)	<b>BSRX...</b>												
		<b>Nameplate</b> with special imprint according to customer's specifications	<b>BSRXB</b>												
		<b>Blank Nameplate</b>	<b>BSRXU</b>												



## Pushbutton Heads (momentary/push-push)

Illustration

Dimensions

Description

Type



### Double Pushbutton

fully assembled with modular contact blocks  
ON-pushbutton green, 1NO  
OFF-pushbutton red, 1NC  
front bezel charcoal

**LDT**

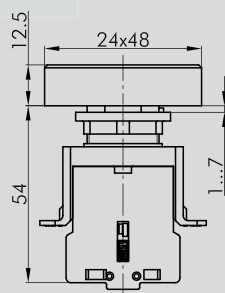

### Illuminated Double Pushbutton

with central signal light between the keys,  
fully assembled with modular contact blocks,  
ON-pushbutton green, 1NO  
OFF-pushbutton red, 1NC  
front bezel charcoal

**LDTL**

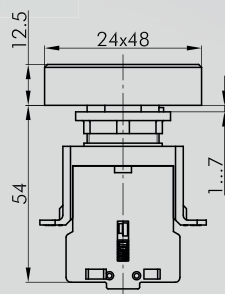

**Emergency Stop Buttons  
Mushroom Heads**

Illustration

Dimensions

Description

Type

IP67



**Sealing Cap**

made of silicone rubber, down to -50°C

**TK50S**



**For further emergency stops, please refer to the chapter „Emergency-stop Heads“ starting on page 362**

The emergency-stop heads can also be supplied as latching mushroom heads with mushrooms in different colours.

IP65

16mm

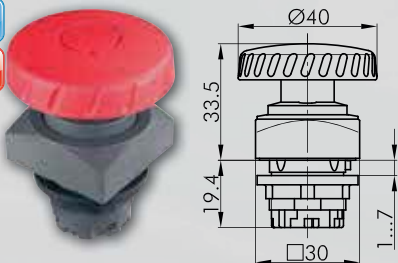

**Mushroom Head, latch-type**

other mushroom colours on request

- |                              |   |
|------------------------------|---|
| foolproof                    | No  |
| switching position indicator | No  |
| anti-lock collar             | No  |
| release                      | twist   |
| Standard                     | EN 60947-5-1, EN 60947-5-5,<br>EN 60068, EN ISO 13850 |



suitable contact blocks



mushroom head red  
front bezel charcoal

**QRV**

IP65

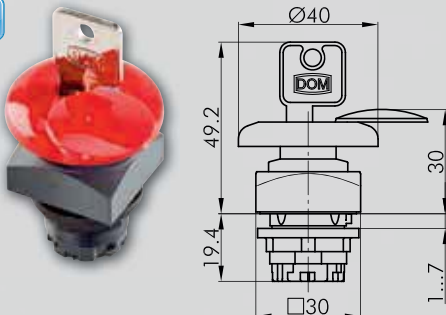

**Mushroom Head, latch-type**

with keyhole cover

- |                              |                       |
|------------------------------|-----------------------|
| foolproof                    | No                    |
| switching position indicator | No                    |
| anti-lock collar             | No                    |
| release                      | key release           |
| Standard                     | DIN EN 60204/VDE 0113 |

suitable contact blocks



mushroom head red  
front bezel charcoal

**QRVSCH**

# QUARTEX-R

Ø 22 mm

## Mushroom Heads

Illustration

Dimensions

Description

Type

IP65  
6mm

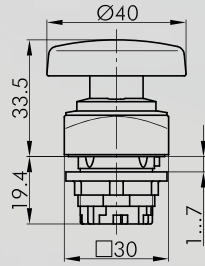

### Mushroom Head, momentary

other mushroom colours on request  
switching position indicator No  
anti-lock collar No

suitable contact blocks



mushroom head red  
front bezel charcoal

QRS

suitable contact blocks











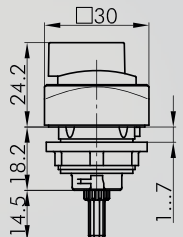

mushroom head black

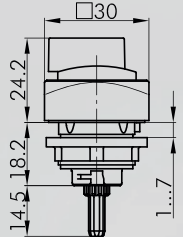
QRS\_SW.PILZ

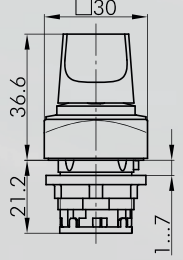
**Knob Set for rotary switches**  
**Knob Set for potentiometers**  
**Selector Heads (momentary/maintained)**

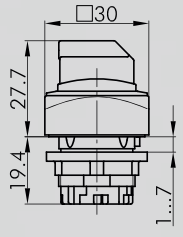
⊥ = Switching position  
> = Spring return

Front rings are supplied in dark-grey as a standard (QRDAU), also available in blue-BL, yellow-GB, green-GN, red-RT, white-WS and black-SW.  
Add code letter to type number (e.g. QRDAURT)

Illustration	Dimensions	Description	Type
		<b>Knob Set for rotary switches, without inscription</b> front bezel charcoal	<b>QRDAU...</b>
		<b>Knob Set for rotary switches, with inscription</b> different versions on request front bezel charcoal	<b>QRDAB...</b>
		<b>Knob Set for potentiometers</b> for potentiometers of 6 mm shaft dia. and thread M10 x 0.75. Delivery without potentiometer. Shaft length: approx. 50 mm ± 2 mm, incl. fastening thread front bezel charcoal	<b>QRR...</b>
		<b>Selector Head, maintained</b> suitable contact blocks  front bezel charcoal suitable contact blocks  front bezel charcoal	 <b>QRWA...</b>  <b>QRWB...</b>

### Selector Heads (momentary/maintained)

Front rings are supplied in dark-grey as a standard (QRSTA), also available in blue-BL, yellow-GB, green-GN, red-RT, white-WS and black-SW.  
Add code letter to type number (e.g. QRSTA\_RRT)

I = Switching position  
> = Spring return

Illustration

Dimensions

Description

Type

IP65

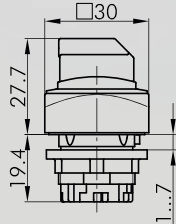

#### Selector Head, momentary

suitable contact blocks



front bezel charcoal

suitable contact blocks



front bezel charcoal



QRSTA...

QRSTB...

IP65

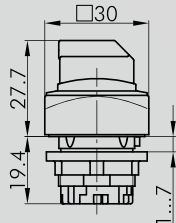

#### Selector Head, left maintained, right momentary

suitable contact blocks



front bezel charcoal



QRWC...

IP65

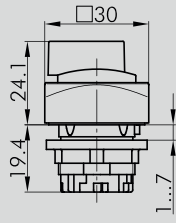

#### Illuminated Selector Head, maintained

inclusive four small, transparent colour plates in red, yellow, green and blue

suitable contact blocks



front bezel charcoal

suitable contact blocks



front bezel charcoal



QRWAL



QRWBL

IP65

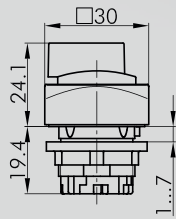

#### Illuminated Selector Head, left maintained, right momentary

suitable contact blocks



front bezel charcoal



QRWCL

### Toggle Heads

Front rings are supplied in dark-grey as a standard (QRK), also available in blue-BL, yellow-GB, green-GN, red-RT, white-WS and black-SW.  
Add code letter to type number (e.g. QRK\_RR.)

Illustration	Dimensions	Description	Type
		<p><b>Toggle Head</b> red toggle (other colours on request) suitable contact blocks</p> <p>      </p> <p>knob colour red front bezel charcoal</p>	<p><b>QRK...</b></p>

- Power
- Control Units
- Accessories
- Bus Technology
- Exhausts
- Terminal Switches
- Water Switches
- Special Blocks

### Key Actuators (momentary/maintained)

Front rings are supplied in dark-grey as a standard QRSSA12E], also available in blue-BL, yellow-GB, green-GN, red-RT, white-WS and black-SW.  
Add code letter to type number (e.g. QRSSAA12E\_RRT)

- I = Switching position
- > = Spring return
- = Key removable position

Illustration

Dimensions

Description

Type

IP65

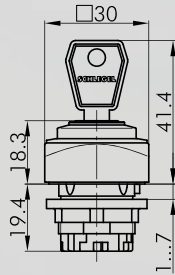

### Key Actuator, maintained

including two keys  
other lock types on request

suitable contact blocks



front bezel charcoal

suitable contact blocks



front bezel charcoal

suitable contact blocks



front bezel charcoal

suitable contact blocks



front bezel charcoal

suitable contact blocks



front bezel charcoal

suitable contact blocks



front bezel charcoal

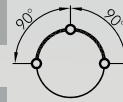

QRSSA12E...

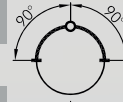

QRSSA13E...

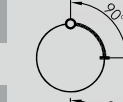

QRSSA14E...



QRSSA15E...



QRSSA17E...

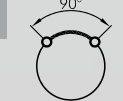

QRSSA18E...

IP65

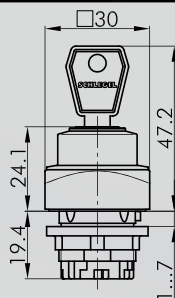

### Key Actuator, momentary

including two keys  
other lock types on request

suitable contact blocks



front bezel charcoal

suitable contact blocks



front bezel charcoal



QRSSA23E...



QRSSA27E...

IP65

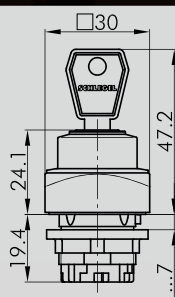

### Key Actuator, left maintained, right momentary

including two keys  
other lock types on request

suitable contact blocks



front bezel charcoal







QRSSA24E...

**Key Actuators (momentary/maintained)**

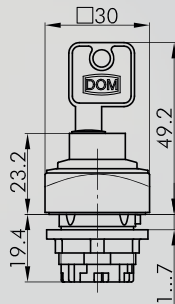
Front rings are supplied in dark-grey as a standard (QRSCHA..), also available in blue-BL, yellow-GB, green-GN, red-RT, white-WS and black-SW.  
Add code letter to type number (e.g. QRSCHA...\_RRT)

- I = Switching position
- > = Spring return
- = Key removable position

Illustration	Dimensions	Description	Type
		<p><b>Lockable Pushbutton Head</b> including two keys</p> <p><b>Type N:</b> Depresses with or without key. Lock latches in depressed position and resets with key turned clockwise. Key removable in both positions.</p> <p><b>Type 1:</b> Depresses only with key turned clockwise. Turn key into vertical position, the lock latches. Reset by turning key clockwise. Key removable in both vertical positions.</p> <p><b>Type 2:</b> Depresses only with key in the right position (= basic position). Turn key into vertical position, the lock latches. Key only removable in the latching position. Reset by turning key clockwise.</p> <p><b>Type 3:</b> Depresses only with key turned clockwise. The lock does NOT latch in depressed position (key neither turnable nor removable in depressed position; MOMENTARY). Key only removable in the off-position.</p> <p>suitable contact blocks  </p> <p>front bezel charcoal <b>QRSCHA...</b></p>	
		<p><b>Spare Keys</b> standard spare key, specify key number for special locks</p>	<b>ES3A36</b>
		<p><b>Spare Key (standard)</b> standard spare key, specify key number for special locks</p>	<b>ESE845</b>



## Pilot Light Heads/Pilot Lights

Front rings are supplied in dark-grey as a standard (QRN), also available in blue-BL, yellow-GB, green-GN, red-RT, white-WS and black-SW.  
 Add code letter to type number (e.g. QRN\_RRT).  
 Lenses and nameplates to be ordered separately

Illustration

Dimensions

Description

Type

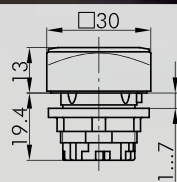

### Pilot Light Head

suitable lampholders



front bezel charcoal

QRN...



### Convex Lens

colour	blue	<b>KF23BL</b>
	yellow	<b>KF23GB</b>
	green	<b>KF23GN</b>
	clear	<b>KF23KL</b>
	red	<b>KF23RT</b>
	opalwhite	<b>KF23WS</b>



### High Lens, transparent

colour	blue	<b>KH23BL</b>
	yellow	<b>KH23GB</b>
	green	<b>KH23GN</b>
	clear	<b>KH23KL</b>
	red	<b>KH23RT</b>
	opalwhite	<b>KH23WS</b>



### Concave Lens, transparent

colour	blue	<b>T26DBL</b>
	yellow	<b>T26DGB</b>
	green	<b>T26DGN</b>
	clear	<b>T26DKL</b>
	red	<b>T26DRT</b>
	opalwhite	<b>T26DWS</b>



### Nameplate

with standard imprint, please specify index number (see nameplates on pages 410)

**BSK...**

### Nameplate

with special imprint according to customer's specifications







**BSKB**





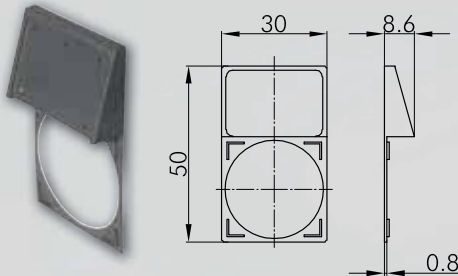

### Blank Nameplate

**BSKU**

**Accessories for Actuators**

Illustration	Dimensions	Description	Type
		<b>Mounting Tool</b> with torque limitation for the series QUARTEX-R(JUWEL), KOMBITAST-R-JUWEL, RONDEX, RONDEX-M, RVA, DUX-Basic	<b>S22</b>
		<b>Mounting Tool Adapter with 1/4" connections</b> for mounting tools S16 and S22	<b>SRA</b>
		<b>External Nameplate Holder</b> for outside marking of the actuators of the QUARTEX-R series, accepts self-adhesive nameplates  colour charcoal	<b>QRABT</b>
		<b>Self-adhesive Nameplate, laser-printed</b> Inscription according to customer's specifications Dimensions: 19 x 27 mm	<b>BZ23G</b>
		<b>Self-adhesive Nameplate, blank</b> Dimensions: 19 x 27 mm	<b>BZ23U</b>
		<b>Self-adhesive Nameplate</b> with standard inscription, please specify index no. (see nameplates on pages 410) Dimensions: 19 x 27 mm	<b>BZ23B...</b>
		<b>Yellow Nameplate</b> self-adhesive PVC foil printing on request outer dia. 75 mm for mounting dia. 22 mm colour yellow	<b>NAS_22</b>

## Accessories for Actuators

Illustration	Dimensions	Description	Type
		<b>Yellow Nameplate with quadrilingual imprint</b> self-adhesive PVC foil outer dia. 75 mm for mounting dia. 22 mm colour yellow	<b>NAS_22_548</b>
		<b>Lamp Remover</b> for incandescent lamps FZR9...	<b>LZ8</b>
		<b>Universal Lens Remover</b>	<b>USK</b>
IP65 		<b>Dummy</b> to close unused mounting apertures colour charcoal	<b>BVQR</b>



Index
Control Units
Accessories
Bus Technology
Exhausts
Ignition Systems
Waste Facilities
Formal Book