

Front dimensions: Ø 28 mm
Panel cut-out: Ø 22.3 mm
Front bezel height: 12 mm
Travel: 6 mm





RONDEX




01 Pushbutton Heads	page 200	07 Key Actuators	page 206
02 Emergency Stop Buttons	page 202	08 Acoustic Buzzers	page 208
03 Mushroom Heads	page 202	09 Pilot Lights	page 209
04 Knob Set for Rotary Switch / Potentiometer	page 204		
05 Selector Heads	page 204		
06 Toggle Heads	page 205		
		Contact Blocks / Lampholders	page 414

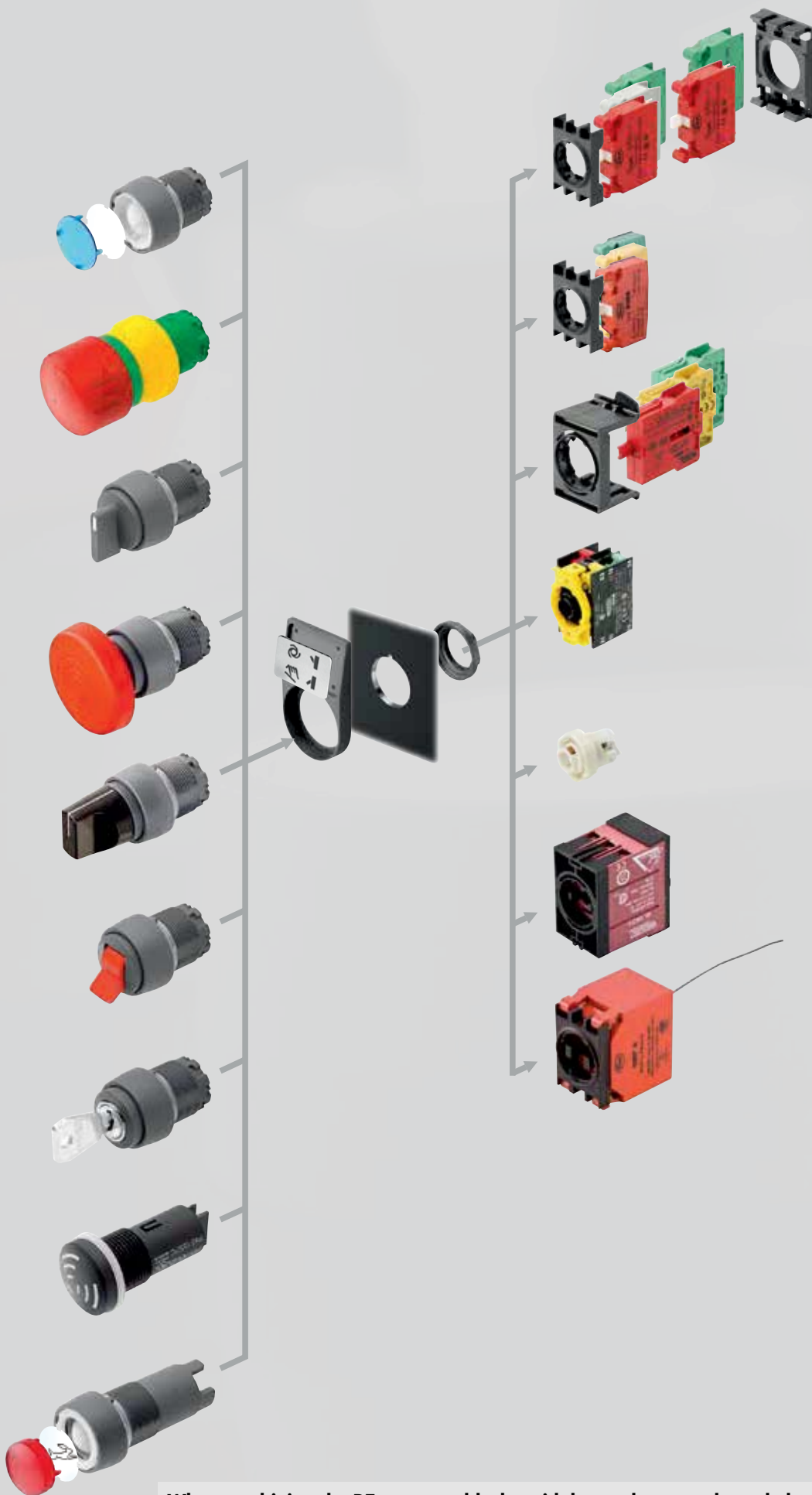


 degree of protection

 illuminating option

 operating travel

 labelling option



DT...
Modular Contact Blocks
spring-clamp connection
page 546



DS...
Modular Contact Blocks
push-in connection
page 540



MT...
Modular Contact Blocks
screw connection
page 530



ET...
Contact Blocks
screw connection
page 524



ASI...
Contact Blocks
for AS-Interface
Safety @ Work
page 564

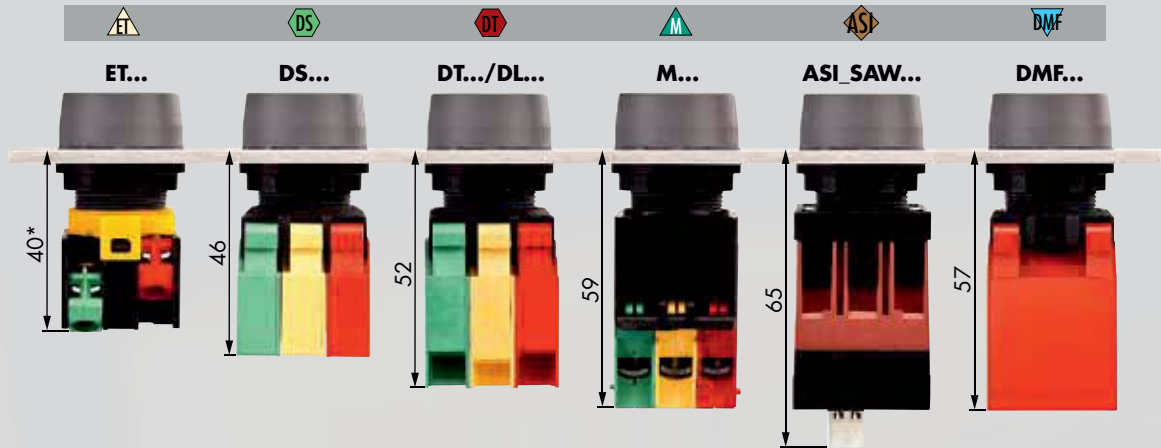


DMF...
Battery-free
Transmitter Module
page 570

**When combining the DT... contact blocks with key, selector and toggle heads,
please add ..._497 to the actuator type reference!**

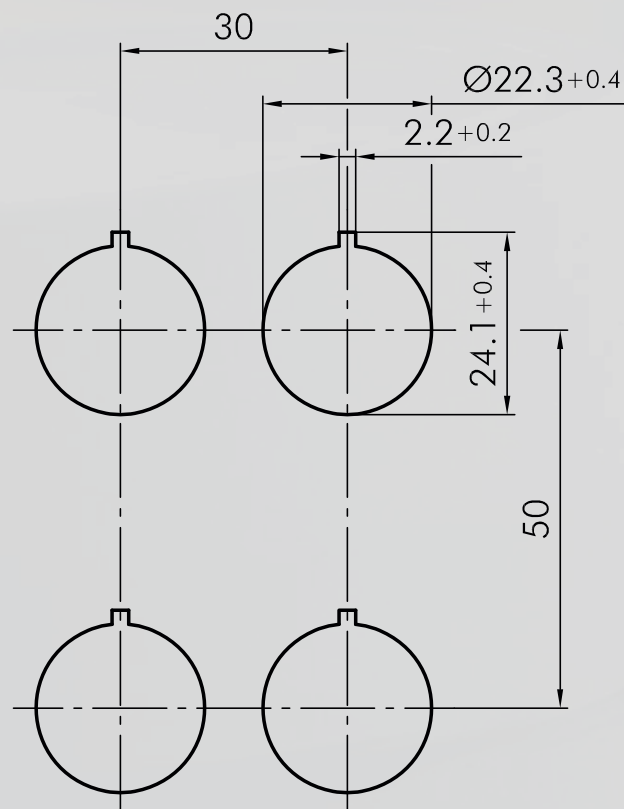


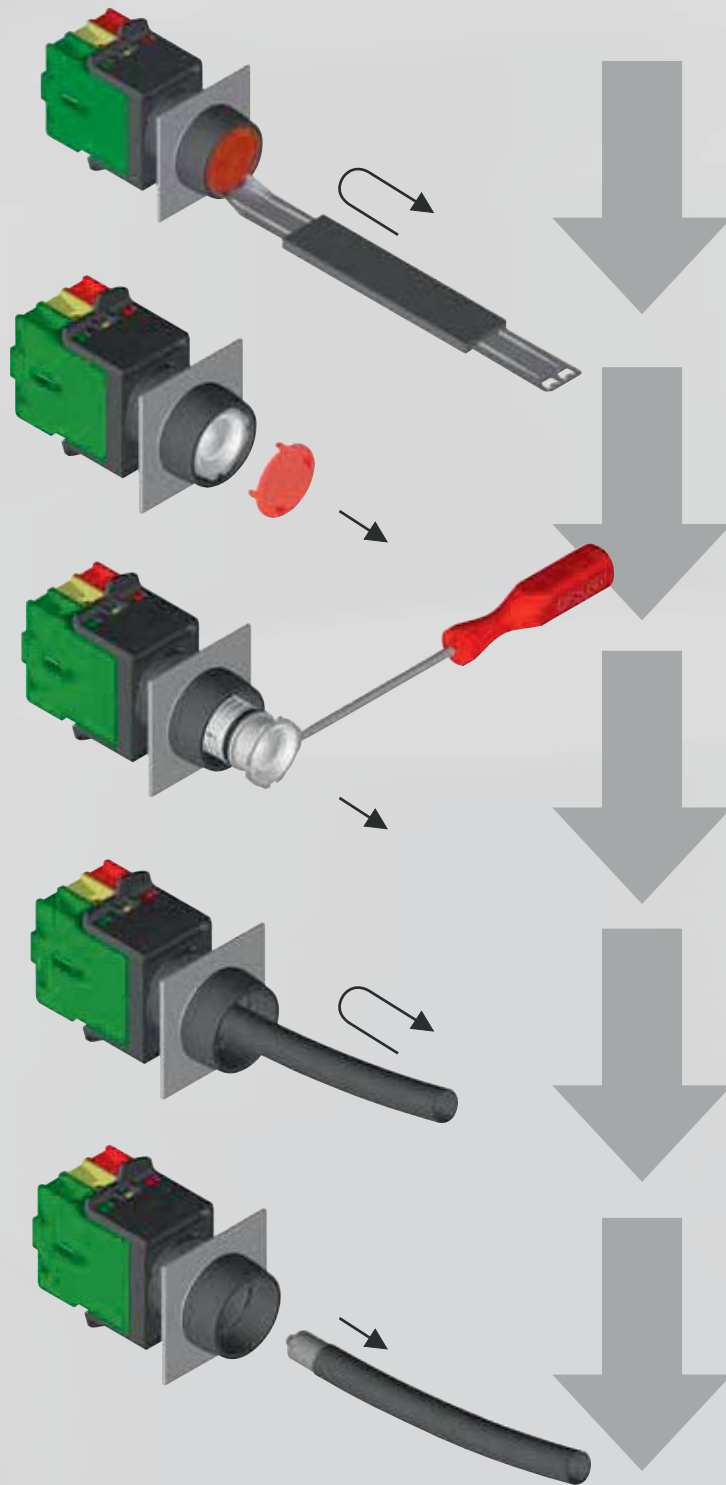
Mounting Depth Dimensions



* ETR2 61mm, ETLR 50mm, ETLR2 70mm, EL9R 36mm

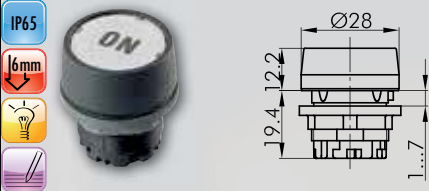





Cutout Dimensions












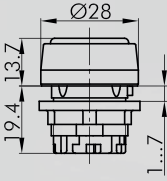







Pushbutton Heads (momentary/push-push)

Lenses and nameplates to be ordered separately

Illustration	Dimensions	Description	Type
		Pushbutton Head suitable contact blocks  front bezel charcoal	RT
		Flat Lens, transparent colour <ul style="list-style-type: none"> blue TG22BL yellow TG22GB green TG22GN clear TG22KL red TG22RT opalwhite TG22WS 	
		Flat Lens, non-transparent used in pushbuttons without inscription and illumination colour <ul style="list-style-type: none"> blue TG22GBL yellow TG22GGB green TG22GGN black TG22GSW red TG22GRT white TG22GWS 	
		High Lens, transparent colour <ul style="list-style-type: none"> blue KH23BL yellow KH23GB green KH23GN clear KH23KL red KH23RT opalwhite KH23WS 	
		High Lens, non-transparent used in pushbuttons without inscription and illumination colour <ul style="list-style-type: none"> blue TG22GHBL yellow TG22GHGB green TG22GHGN black TG22GHSW red TG22GHRT white TG22GHWS 	

Pushbutton Heads (momentary/push-push)

Lenses and nameplates to be ordered separately

Illustration	Dimensions	Description	Type
		Nameplate with standard imprint, please specify index number (see nameplates on pages 410)	BSK...
		Nameplate with special imprint according to customer's specifications	BSKB
		Blank Nameplate	BSKU
     		Membrane Pushbutton Head with tightly closed, transparent silicone cap, down to -50° C suitable contact blocks      front bezel charcoal	RTM
		Flat Lens, transparent colour	blue T20FBL yellow T20FGB green T20FGN clear T20FKL red T20FRT opalwhite T20FWS
		Nameplate with standard imprint, please specify index number (see nameplates on pages 410)	BSRX...
		Nameplate with special imprint according to customer's specifications	BSRXB
		Blank Nameplate	BSRXU

Pushbutton Heads (momentary/push-push)
Emergency Stop Buttons
Mushroom Heads

Illustration	Dimensions	Description	Type
--------------	------------	-------------	------

IP67

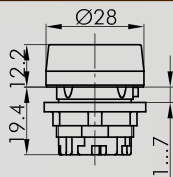
Sealing Cap

made of silicone rubber, down to -50°C

TK29S

IP65

16mm



Economy Pushbutton Head

no inscription, no illumination

suitable contact blocks



push-cap	green	RTG
front bezel	charcoal	
push-cap	red	RTR
push-cap	black	RTS
push-cap	white	RTW
push-cap	yellow	RTY
push-cap	blue	RTB

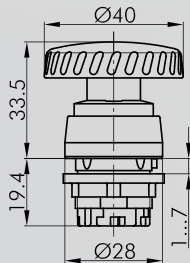


For further emergency stops, please refer to the chapter „Emergency-stop Heads“ starting on page 362

The emergency-stop heads can also be supplied as latching mushroom heads with mushrooms in different colours.

IP65

16mm



Mushroom Head, latch-type

Other mushroom colours on request

foolproof	No
switching position indicator	No
anti-lock collar	No
release	twist
Standard	EN 60947-5-1, EN 60947-5-5, EN 60068, EN ISO 13850



suitable contact blocks



mushroom head	red	RV
front bezel	charcoal	

Mushroom Heads

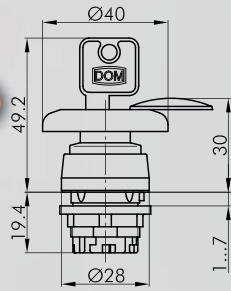
Illustration

Dimensions

Description

Type

IP65



Mushroom Head, latch-type

with keyhole cover

foolproof No
switching position indicator No
anti-lock collar No
release key release
Standard DIN EN 60204/VDE 0113

suitable contact blocks

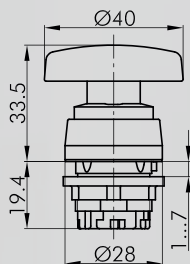


mushroom head red
front bezel charcoal

RVSCH

IP65

16mm



Mushroom Head, momentary

other mushroom colours on request

switching position indicator No
anti-lock collar No

suitable contact blocks



mushroom head red
front bezel charcoal

RS

suitable contact blocks


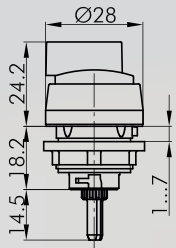

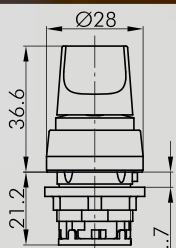

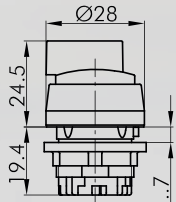





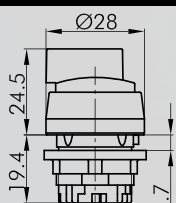






mushroom head black

RS_SW.PILZ


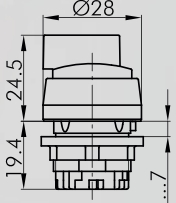


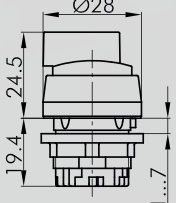



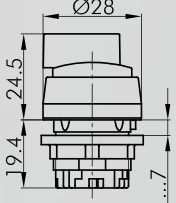


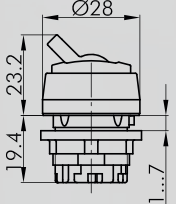
Knob Set for rotary switches
Knob Set for potentiometers
Selector Heads (momentary/maintained)

I = Switching position
 > = Spring return

Illustration	Dimensions	Description	Type
		Knob Set for rotary switches, without inscription different versions on request front bezel charcoal	RDA
		Knob Set for potentiometers for potentiometers of 6 mm shaft dia. and thread M10 x 0.75. Delivery without potentiometer. Shaft length: approx. 50 mm ± 2 mm incl. fastening thread front bezel charcoal	RR
		Selector Head, maintained suitable contact blocks  front bezel charcoal suitable contact blocks  front bezel charcoal	 RWA  RWB
		Selector Head, momentary suitable contact blocks  front bezel charcoal suitable contact blocks  front bezel charcoal	 RSTA  RSTB

**Selector Heads (momentary/maintained)
Toggle Heads**

I = Switching position
> = Spring return

Illustration	Dimensions	Description	Type
	 <p>Ø28 24.5 19.4 1...7</p>	<p>Selector Head, left maintained, right momentary suitable contact blocks front bezel charcoal</p>	 <p>RWC</p>
	 <p>Ø28 24.5 19.4 1...7</p>	<p>Illuminated Selector Head, maintained inclusive four small, transparent colour plates in red, yellow, green and blue suitable contact blocks front bezel charcoal</p>	 <p>RWAL</p>  <p>RWBL</p>
	 <p>Ø28 24.5 19.4 1...7</p>	<p>Illuminated Selector Head, left maintained, right momentary inclusive four small, transparent colour plates in red, yellow, green and blue suitable contact blocks front bezel charcoal</p>	 <p>RWCL</p>
	 <p>Ø28 23.2 19.4 1...7</p>	<p>Toggle Head red toggle (other colours on request) suitable contact blocks knob colour red front bezel charcoal</p>	<p>RK</p>

Key Actuators (momentary/maintained)

- I = Switching position
- > = Spring return
- = Key removable position

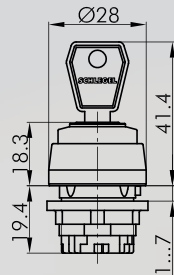
Illustration

Dimensions

Description

Type

IP65



Key Actuator, maintained

including two keys
other lock types on request

suitable contact blocks



front bezel charcoal

suitable contact blocks



front bezel charcoal

suitable contact blocks



front bezel charcoal

suitable contact blocks



front bezel charcoal

suitable contact blocks



front bezel charcoal

suitable contact blocks



front bezel charcoal



RSSA12E



RSSA13E



RSSA14E



RSSA15E

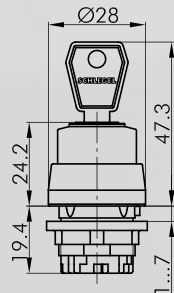


RSSA17E



RSSA18E

IP65



Key Actuator, momentary

including two keys
other lock types on request

suitable contact blocks



front bezel charcoal

suitable contact blocks



front bezel charcoal

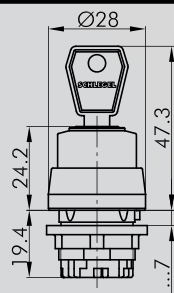


RSSA23E



RSSA27E

IP65



Key Actuator, left maintained, right momentary

including two keys
other lock types on request

suitable contact blocks



front bezel charcoal



RSSA24E

Key Actuators (momentary/maintained)

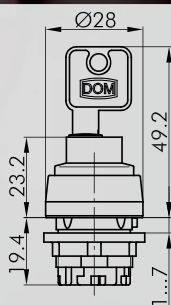
Illustration

Dimensions

Description

Type

IP65



Lockable Pushbutton Head

including two keys

Type N:

Depresses with or without key. Lock latches in depressed position and resets with key turned clockwise. Key removable in both positions.

Type 1:

Depresses only with key turned clockwise. Turn key into vertical position, the lock latches. Reset by turning key clockwise. Key removable in both vertical positions.

Type 2:

Depresses only with key in the right position (= basic position). Turn key into vertical position, the lock latches. Key only removable in the latching position. Reset by turning key clockwise.

Type 3:

Depresses only with key turned clockwise. The lock does NOT latch in depressed position (key neither turnable nor removable in depressed position; MOMENTARY). Key only removable in the off-position.

suitable contact blocks



front bezel

charcoal

RSCHA...



Spare Keys

standard spare key, specify key number for special locks

ES3A36



Spare Key (standard)

standard spare key, specify key number for special locks

ESE845

Buzzers

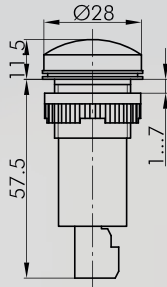
Illustration

Dimensions

Description

Type

IP65

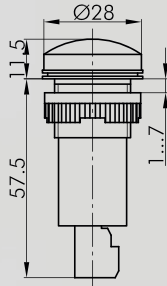


Buzzer 230V

Operating voltage: 230V~
 Volume: 80 dB at 10 cm distance
 Mounting depth: 60 mm
 max. ambient temperature: -20°C up to 50°C
 Service life: > 5000 h
 front bezel black

RSG-230V

IP65




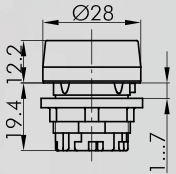



Buzzer 24V

Operating voltage: 18 - 30V AC/DC
 Volume: 80 dB at 10 cm distance
 Mounting depth: 60 mm
 max. ambient temperature: -20°C up to 50°C
 Service life: > 5000 h
 front bezel black

RSG-24V


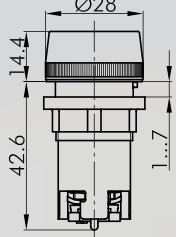

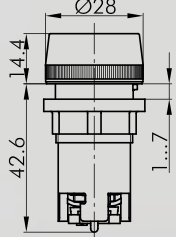

Pilot Light Heads/Pilot Lights

Lenses and nameplates to be ordered separately




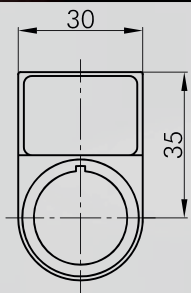



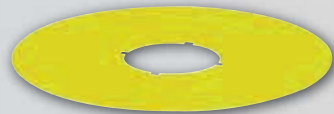
Illustration	Dimensions	Description	Type
		<p>Pilot Light Head suitable lampholders</p> <p>front bezel charcoal</p>	RN
		<p>Convex Lens</p> <p>colour</p> <ul style="list-style-type: none"> blue yellow green clear red opalwhite 	<p>KF23BL</p> <p>KF23GB</p> <p>KF23GN</p> <p>KF23KL</p> <p>KF23RT</p> <p>KF23WS</p>
		<p>High Lens, transparent</p> <p>colour</p> <ul style="list-style-type: none"> blue yellow green clear red opalwhite 	<p>KH23BL</p> <p>KH23GB</p> <p>KH23GN</p> <p>KH23KL</p> <p>KH23RT</p> <p>KH23WS</p>
		<p>Nameplate</p> <p>with standard imprint, please specify index number (see nameplates on pages 410)</p>	BSK...
		<p>Nameplate</p> <p>with special imprint according to customer's specifications</p>	BSKB
		<p>Blank Nameplate</p>	BSKU

Pilot Light Heads/Pilot Lights





Lenses and nameplates to be ordered separately

Illustration	Dimensions	Description	Type
 <p>IP65</p>		<p>LED Pilot Light 230V</p> <p>Rated voltage: 230 V AC / 50 ... 60 Hz Rated current: max. 20 mA Connection type: screw connections for 2 x 2.5 mm² Operating temperature: -25 °C ... 55 °C</p> <p>for 440V on request</p> <p>colour</p>	<p>blue green white yellow red</p> <p>RGLED230V_B RGLED230V_G RGLED230V_W RGLED230V_Y RGLED230V_R</p>
 <p>IP65</p>		<p>LED Pilot Light 24V</p> <p>Rated voltage: 24 V AC / DC Rated current: max. 80 mA Connection type: screw connections for 2 x 2.5 mm² Operating temperature: -25 °C ... 55 °C</p> <p>colour</p>	<p>blue red yellow white green</p> <p>RGLED24V_B RGLED24V_R RGLED24V_Y RGLED24V_W RGLED24V_G</p>
		<p>Panoramic Lens</p> <p>colour</p>	<p>blue yellow green clear red white</p> <p>KG22BL KG22GB KG22GN KG22KL KG22RT KG22WS</p>

Accessories for Actuators

Illustration	Dimensions	Description	Type
		Mounting Tool with torque limitation for the series QUARTEX-R(JUWEL), KOMBITAST-R-JUWEL, RONDEX, RONDEX-M, RVA, DUX-Basic	S22
		Mounting Tool Adapter with 1/4" connections for mounting tools S16 and S22	SRA
		External Nameplate Holder for outside marking of the actuators of the RONDEX series, accepts self-adhesive nameplates colour charcoal	RABT
		Self-adhesive Nameplate, laser-printed Inscription according to customer's specifications Dimensions: 19 x 27 mm	BZ23G
		Self-adhesive Nameplate, blank Dimensions: 19 x 27 mm	BZ23U
		Self-adhesive Nameplate with standard inscription, please specify index no. (see nameplates on pages 410) Dimensions: 19 x 27 mm	BZ23B...
		Yellow Nameplate self-adhesive PVC foil printing on request outer dia. 75 mm for mounting dia. 22 mm colour yellow	NAS_22

Accessories for Actuators

Illustration	Dimensions	Description	Type
		Yellow Nameplate with quadrilingual imprint self-adhesive PVC foil outer dia. 75 mm for mounting dia. 22 mm colour yellow	NAS_22_548
		Lamp Remover for incandescent lamps FZR9...	LZ8
		Universal Lens Remover	USK
IP65 		Dummy to close unused mounting apertures colour charcoal	BVR22



Quality

Control Units

Accounting

Bus Technology

Enclosures

Limit Switches

Photo Switches

Terminal Blocks