



Front dimensions: 28 x 28 mm  
Panel cut-out: Ø 22.3 mm  
Front bezel height: 2 mm  
Travel: 3 mm





RONTRON-Q-JUWEL



01 Pushbutton Heads	page 150	07 USB/RJ45 Jacks	page 157
02 Emergency Stop Buttons	page 151	08 Pilot Lights	page 159
03 Selector Heads	page 151		
04 Key Actuators	page 151		
05 Acoustic Buzzers	page 153		
06 Pilot Lights	page 155		
		<b>Contact Blocks / Lampholders</b>	page 414











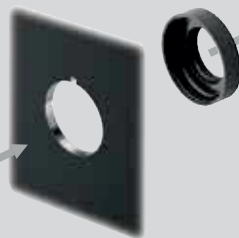

 degree of protection

 illuminating option

 operating travel

 labelling option



- 
**CT...**  
 Contact Blocks  
 Faston terminals  
**page 510**
- 
**CZ...**  
 Contact Blocks  
 PCB-mount terminals  
**page 502**
- 
**CTP...**  
 Contact Blocks  
 PCB-mount terminals  
**page 486**
- 
**CTF...**  
 Contact Blocks  
 Faston terminals  
**page 494**
- 
**PTP...**  
 Contact Blocks  
 PCB-mount terminals  
**page 518**
- 
**PTF...**  
 Contact Blocks  
 Faston terminals  
**page 518**
- 
**B...**  
 Contact Blocks  
 Faston terminals  
**page 434**
- 
**BZ...**  
 Contact Blocks  
 Screw connections  
**page 476**
- 
**ASI...**  
 Contact Blocks  
 for AS-Interface  
**page 558**
- 
**AS...**  
 Contact Blocks  
 for AS-Interface  
 Safety @ Work  
**page 564**

## Mounting Depth Dimensions

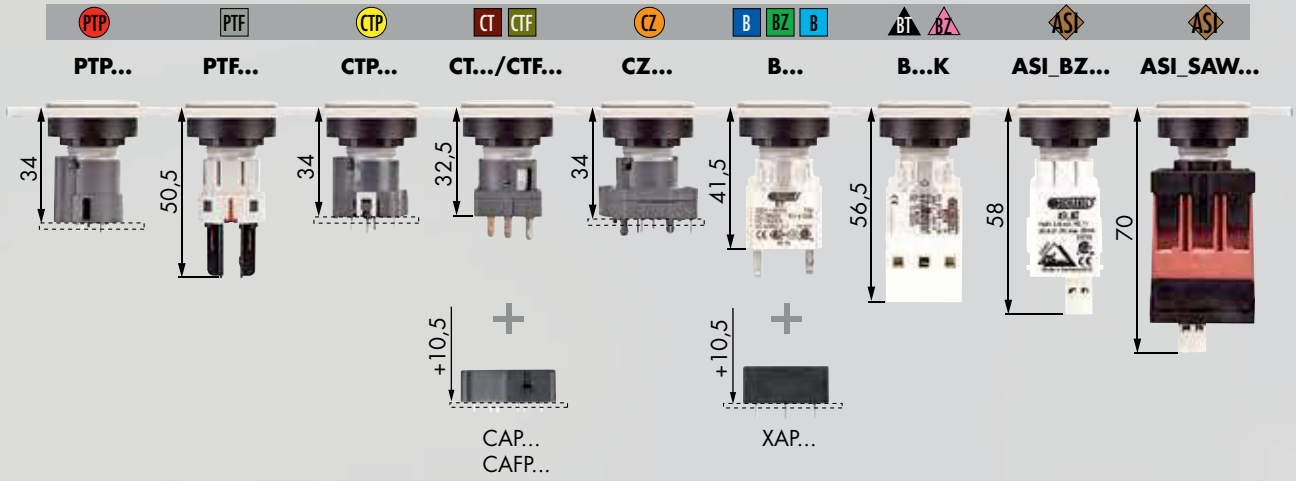

## Cutout Dimensions

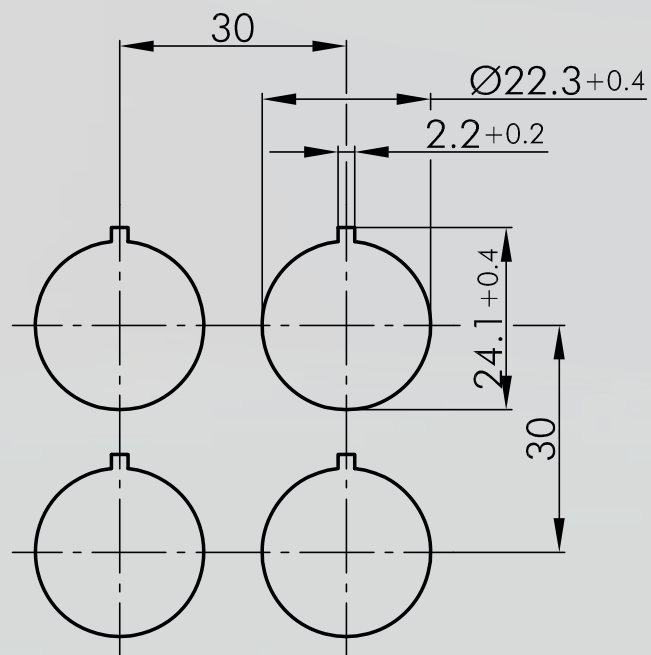

## Mounting and Service Instructions

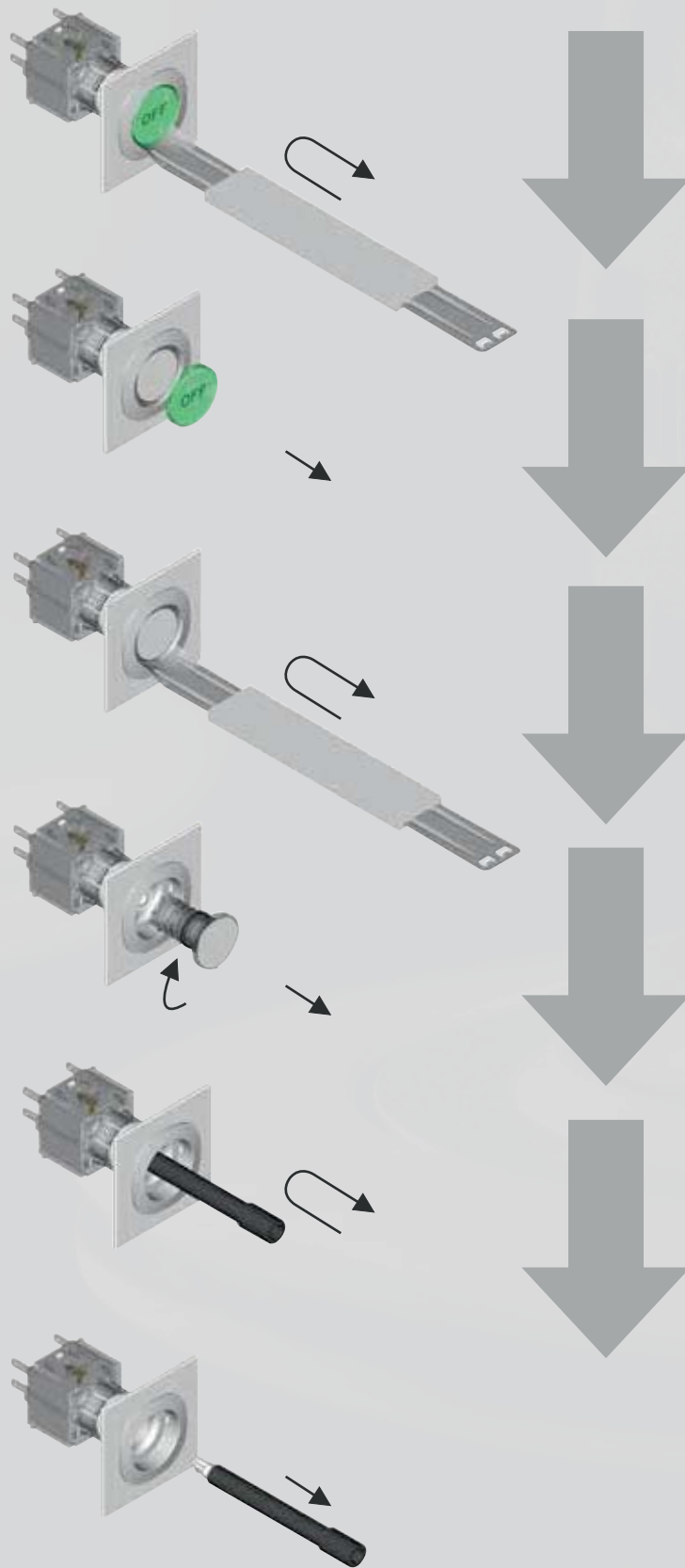

# RONTRON-Q-JUWEL

Ø 22 mm

## Pushbutton Heads (momentary/push-push)

Lenses and nameplates to be ordered separately

Illustration	Dimensions	Description	Type
		<b>Pushbutton Head</b>  suitable contact blocks 	front bezel metallic <b>RQJT</b>
		<b>Flat Lens, transparent</b> colour blue yellow green clear red opalwhite	<b>T22RRBL</b> <b>T22RRGB</b> <b>T22RRGN</b> <b>T22RRKL</b> <b>T22RRRT</b> <b>T22RRWS</b>
		<b>Flat Lens, non-transparent</b> colour blue yellow green black red white	<b>T22RRGBL</b> <b>T22RRGGB</b> <b>T22RRGGN</b> <b>T22RRGSW</b> <b>T22RRGRT</b> <b>T22RRGWS</b>
		<b>Blank Nameplate</b>	<b>BSRRU</b>
		<b>Nameplate</b> with standard imprint, please specify index number (see nameplates on pages 410)	<b>BSRR...</b>
		<b>Nameplate</b> with special imprint according to customer's specifications	<b>BSRRB</b>
		<b>Pushbutton Head with ring illumination</b> with lens, inscription on request  suitable contact blocks 	front bezel metallic black <b>RQJTLR</b> <b>RQJTLRESW</b>

**Emergency Stop Buttons**  
**Knob Set for potentiometers**  
**Selector Heads (momentary/maintained)**

I = Switching position  
> = Spring return

Illustration

Dimensions

Description

Type



**For further emergency stops, please refer to the chapter „Emergency-stop Heads“ starting on page 362**

The emergency-stop heads can also be supplied as latching mushroom heads with mushrooms in different colours.

IP65

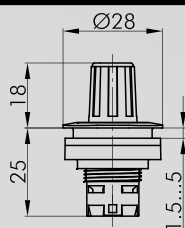

**Knob Set for potentiometers**

for potentiometers of 6 mm shaft dia. and thread M10 x 0.75.  
Delivery without potentiometer.  
Shaft length: approx. 32 mm  
front bezel                      metallic

**RQJR**

IP65

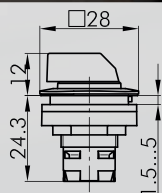

**Selector Head, maintained**

suitable contact blocks



front bezel                      metallic

suitable contact blocks



front bezel                      metallic



**RQJWA**

**RQJWB**

IP65

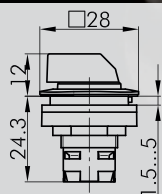

**Selector Head, momentary**

suitable contact blocks



front bezel                      metallic

suitable contact blocks



front bezel                      metallic



**RQJSTA**

**RQJSTB**



Ø 22 mm

## Selector Heads (momentary/maintained)

I = Switching position  
> = Spring return

Illustration	Dimensions	Description	Type
		<p><b>Selector Head, left maintained, right momentary</b></p> <p>suitable contact blocks</p> <p>front bezel                      metallic</p>	<p><b>RQJWC</b></p>
		<p><b>Illuminated Selector Head, maintained</b></p> <p>Knob available in blue-BL, yellow-GB, clear-KL, green-GN, red-RT (e.g. RQJWAL_GN)</p> <p>suitable contact blocks</p> <p>front bezel                      metallic</p> <p>suitable contact blocks</p> <p>front bezel                      metallic</p>	<p><b>RQJWAL...</b></p> <p><b>RQJWBL...</b></p>
		<p><b>Illuminated Selector Head, momentary</b></p> <p>Knob available in blue-BL, yellow-GB, clear-KL, green-GN, red-RT (e.g. RQJSTAL_GN)</p> <p>suitable contact blocks</p> <p>front bezel                      metallic</p> <p>suitable contact blocks</p> <p>front bezel                      metallic</p>	<p><b>RQJSTAL...</b></p> <p><b>RQJSTBL...</b></p>
		<p><b>Illuminated Selector Head, left maintained, right momentary</b></p> <p>Knob available in blue-BL, yellow-GB, clear-KL, green-GN, red-RT (e.g. RQJWCL_GN)</p> <p>suitable contact blocks</p> <p>front bezel                      metallic</p>	<p><b>RQJWCL...</b></p>

## Key Actuators (momentary/maintained)

- I = Switching position
- > = Spring return
- = Key removable position

Illustration

Dimensions

Description

Type

IP65

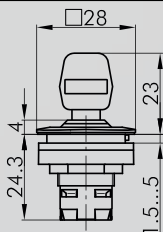

### Key Actuator, maintained

including two keys  
other lock types on request

suitable contact blocks



front bezel metallic

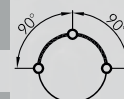

**RQJSSA12**

suitable contact blocks



front bezel metallic

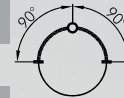

**RQJSSA13**

suitable contact blocks



front bezel metallic



**RQJSSA14**

suitable contact blocks



front bezel metallic



**RQJSSA15**

suitable contact blocks



front bezel metallic



**RQJSSA16**

suitable contact blocks



front bezel metallic

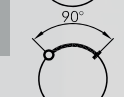

**RQJSSA17**

suitable contact blocks



front bezel metallic

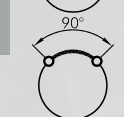

**RQJSSA18**

IP65

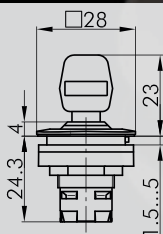

### Key Actuator, maintained (special lock)

including 3 keys:  
1st key: two-way operation  
2nd key: operation to the left only  
3rd key: operation to the right only

suitable contact blocks



front bezel metallic

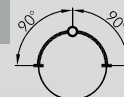

**RQJSSA31**

# RONTRON-Q-JUWEL

Ø 22 mm

## Key Actuators (momentary/maintained)

- I = Switching position
- > = Spring return
- = Key removable position

Illustration

Dimensions

Description

Type

IP65

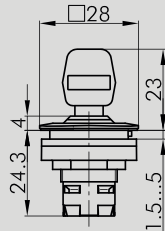

### Key Actuator, momentary

including two keys  
other lock types on request

suitable contact blocks



front bezel metallic

suitable contact blocks



front bezel metallic



**RQJSSA23**



**RQJSSA28**

IP65

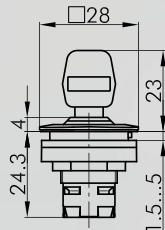

### Key Actuator, left maintained, right momentary

including two keys  
other lock types on request

suitable contact blocks



front bezel metallic

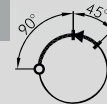

**RQJSSA25**



### Standard Spare Keys



standard spare key, specify key number for special locks

**ESMIC482**









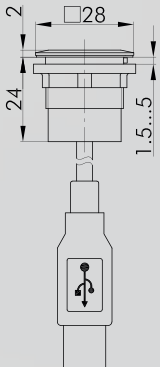

Ø 22 mm

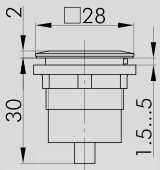
## Accessories for Contact blocks

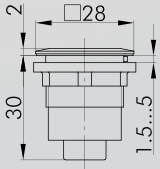
Illustration	Dimensions	Description	Type
		<b>Insulating Case</b> for Faston clamp FH2,8, slip on from the front	<b>IH2,8</b>
		<b>Double Faston</b> for the connection of 2 Faston clamps FH2.8	<b>FD2,8</b>

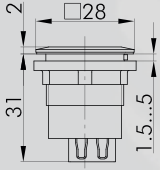
## USB Sockets

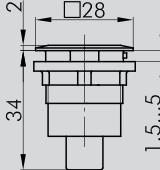
Illustration	Dimensions	Description	Type
		<p><b>USB Jack</b> front: USB jack type A</p> <p>rear: USB2.0 cable (length 60 cm) with connector type A</p> <p>front bezel                      metallic</p>	<b>RQJ_USB</b>
		<p><b>USB Jack</b> front: USB jack type A</p> <p>rear: USB jack type A</p> <p>front bezel                      metallic</p>	<b>RQJ_USB_AA</b>
		<p><b>USB Jack</b> front: USB jack type A</p> <p>rear: USB jack type B</p> <p>front bezel                      metallic</p>	<b>RQJ_USB_AB</b>
		<p><b>USB Jack</b> front: USB jack type B</p> <p>rear: USB jack type A</p> <p>front bezel                      metallic</p>	<b>RQJ_USB_BA</b>
		<p><b>USB Jack</b> front: USB jack type B</p> <p>rear: USB jack type B</p> <p>front bezel                      metallic</p>	<b>RQJ_USB_BB</b>

Ø 22 mm

## USB Sockets

Illustration	Dimensions	Description	Type
		<p><b>USB3.0 Jack</b>                      front:                      USB jack type A</p> <p>rear:                      USB jack type A                      front bezel</p>	<p>metallic</p> <p><b>RQJ_USB3_AA</b></p>
		<p><b>Fire Wire Jack</b>                      front:                      Fire Wire jack</p> <p>rear:                      Fire Wire jack                      front bezel</p>	<p>metallic</p> <p><b>RQJ_FW6_STB</b></p>
		<p><b>RJ45 Jack</b>                      front:                      RJ45 jack with screen</p> <p>rear:                      60cm cable screened with RJ45 connector                      front bezel</p>	<p>metallic</p> <p><b>RQJ_RJ45</b></p>
		<p><b>RJ45 Jack</b>                      front:                      RJ45 jack with screen</p> <p>rear:                      RJ45 jack with screen                      front bezel</p>	<p>metallic</p> <p><b>RQJ_RJ45_STB</b></p>





## Pilot Light Heads/Pilot Lights

Lenses and nameplates to be ordered separately

Illustration	Dimensions	Description	Type
		<b>Pilot Light with Faston terminals</b> <b>2.8x0.8 mm</b> W2x4.6d socket front bezel                      metallic	<b>RQJL4</b>
		<b>Pilot Light Head</b> suitable lampholders front bezel                      metallic	<b>RQJN</b>
		<b>Lens</b> colour                      blue yellow green clear red opalwhite	<b>K22RRBL</b> <b>K22RRGB</b> <b>K22RRGN</b> <b>K22RRKL</b> <b>K22RRRT</b> <b>K22RRWS</b>
		<b>Nameplate</b> with standard imprint, please specify index number (see nameplates on pages 410)	<b>BSRR...</b>
		<b>Nameplate</b> with special imprint according to customer's specifications	<b>BSRRB</b>
		<b>Blank Nameplate</b>	<b>BSRRU</b>

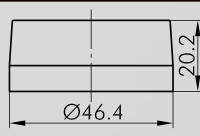

## Accessories for Actuators

Illustration	Dimensions	Description	Type
		<b>Hexagonal Mounting Tool</b> with torque limitation, for the series OKTRON, OKTRON-JUWEL, OKTRON-R, RONTRON-R-JUWEL, RONTRON-R-Exclusive, RONTRON-Q- JUWEL, RONTRON-Q-Exclusive, QUARTRON(-L), QUARTRON- JUWEL(-L), RX, RX-JUWEL	<b>S16</b>
		<b>Mounting Tool Adapter with 1/4\" connections</b> for mounting tools S16 and S22	<b>SRA</b>
		<b>Yellow Nameplate</b> self-adhesive PVC foil printing on request outer dia. 75 mm for mounting dia. 22 mm colour yellow	<b>NAS_22</b>
		<b>Yellow Nameplate with quadrilingual imprint</b> self-adhesive PVC foil outer dia. 75 mm for mounting dia. 22 mm colour yellow	<b>NAS_22_548</b>
 		<b>Protective Shroud</b> for actuators of 22 mm mounting dia. colour yellow	<b>RXJSK</b>
		<b>Lamp Remover</b>	<b>LZ-MG</b>
		<b>Universal Lens Remover</b>	<b>USK</b>

## Accessories for Actuators

Illustration	Dimensions	Description	Type
		<p><b>Dummy</b> to close unused mounting apertures front bezel                      metallic</p>	<p><b>BVRQJ</b></p>

- Order
- Accessories
- Central Units
- Bus Technology
- Exchangers
- Limit Switches
- Push Buttons
- Switches