

Operating Instructions

(Translation of the orig. Operating Instructions)

AS-Interface Emergency-Stop Slave Safety at Work



Preface

The AS-Interface Emergency stop slave is a safety slave for the Fieldbus system AS-Interface (standard address mode). Up to 30 slaves can be connected to one AS-Interface line; the 31st connection is a safety monitor. The four inputs serve for the safe transmission of the switching status of the E-STOP. The digital output*1 can be used for the control of external pilot lights, annunciators or for the illumination of the E-Stop. It is not a safety-related output.

 The AS-Interface E-STOP can only fulfill its safety function acc. to the relevant standards in interaction with the AS-Interface safety monitor!

The safety slave can be combined with different E-STOP actuators (refer to "Models and Accessories"), which are operated by pushing and reset by twisting the upper part. By the foolproof trigger function, which is realised by power storing and a snap mechanism, the switching-off function (open + latching) is proceeded in a defined manner.

 The AS-Interface E-STOP may only be used by persons with the appropriate specialised knowledge. It is not intended for sales to the general public.

A third contact*1 in the slave ensures permanent monitoring and safety shutdown in case of unintentional separation of the E-STOP actuator (patent applied).

ASI_SAW16A, ASI_SAW16E
ASI_SAW22A, ASI_SAW22E



Starting Up

The AS-Interface E-STOP is being delivered with the address 0. Within the AS-Interface network each standard slave must have an address from 1 to 31. No address may occur more than once. Moreover, it is not permitted to operate a standard slave and a slave with extended address mode with the same address (e.g. slave 17 and slave 17A or 17B) in the same network.

Addressing with Addressing Device

Before installation in the AS-Interface network the desired address is adjusted by means of the addressing device which is connected via the addressing cable "ASI_PK500M12" to the connections A+ and A- (refer to the description of the addressing device). The optional addressing jack*2 serves to address already integrated slaves (the slave is separated from the network).



Addressing via the AS-Interface Master

Optionally, the AS-Interface E-STOP can be connected to the AS-Interface network and addressed accordingly via the AS-Interface Master (in the configuration mode). It must be observed, however, that always one slave with the address 0 is existing in the network.

Parameterising: is not intended.

 As the starting-up operation means a safety-related procedure it has to be carried out by the safety officer who is responsible for the application.

Installation of the Network

The AS-Interface network is a PELV network. The relevant rules for the installation are to be considered.

Configuration of the Safety Network

The AS-Interface E-STOP can only fulfill its safety function acc. to the relevant standards in interaction with the AS-Interface safety monitor. For starting up the safety monitor must be configured accordingly (please refer to the operating instructions of the safety monitor). After installation a functional check must be carried out.

Failure Probability on demand acc. to IEC61508

For the calculation of the failure probability of the whole system the AS-Interface EMERGENCY-STOP slave supplies one component.

Failure Probability according to IEC 61508

For calculating the failure probability of the whole system, the Asi slave provides a component with the following characteristic numbers:

PFH: 1.03*10⁻¹⁰ PFD: 1.808 *10⁻⁵ SFF: 99.53 % SIL: 3

Together with the failure probability of the other components used in the safety system (e. g. safety monitor), the allover failure probability can be determined. With the result computed from this, a classification into the appropriate safety level can be made according to IEC61508.

Reliability Parameters according to EN ISO 13849-1

The parameters referred to the reliability acc. to EN ISO 13849-1 are as follows: MTTFd: 100 years DC_{avg}: 99 % Category: 4 PL: e

Maintenance and Repair

It is recommended to activate the E-STOP at least once a year in order to examine the proper function of the safety switching system.

 As the annual maintenance means a safety-related procedure it has to be carried out by the safety officer who is responsible for the application.

Repairs, particularly the opening of the housing, may be made only by the manufacturer or by a person authorised by the manufacturer.

Shutdown / Waste Disposal

When decommissioning the E-STOP must be dismantled / removed. The AS-Interface E-STOP does not contain batteries, which would have to be removed before disposal. Electronic trash is hazardous waste, so, please consider the local regulations for disposal.

Connection Assignment

A+, A-: Connection to the AS-Interface network
Using IDC technology, the connections are set up via the 2-pole connector (ref. no.: "ASI_SB2AWG18, ASI_SB2AWG22", "ASI_K2"). The single conductors are pressed into the IDC connector by means of the tool "ASI_MRT" (refer to the accessories)

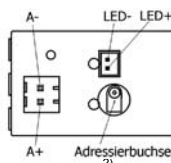

LED+, LED-: Connection for digital output*1
2-pole connector to connect an external pilot light, or for the illumination of the E-Stop, via the connection cable (ref. no.: "VK_JST025BKL", "BK_JST034", refer to the accessories).

 For the output of the external connection a cable of 10 cm max. length may be used. This cable may not be connected with the GND of the plant.. *1)

Technical Data

Communication		V 2.1			
AS-Interface specification					
Slave profile	ASI_SAWxxA	S-7.B.E			
	ASI_SAWxxE	S-0.B.E			
Standby delay time	< 1s				
Input delay	< 5ms				
Connection	Via 2-pole IDC connector				
Ambient Conditions					
Operating temperature:	-25 ... +70 °C				
Degree of protection:	IP20				
Humidity:	max. 95%, non-condensing				
max. vibration (temporary):	1.5mm amplitude (10..55Hz)				
max. shock resistance:	10g				
Electrical Data					
Operating voltage:	26.5...31.6 V, through the AS-Interface line				
Total power consumption:	ASI_SAWxxA:	≤ 60 mA			
	ASI_SAWxxE:	≤ 50 mA			
Reverse polarity protection:	available				
Contacts:	Two positive opening contacts acc. to IEC60947-5-5				
Safety category/integr.level	Kat 4 / SIL 3 / PL e				
Output (not safe):*1	For the control of a LED				
- rated voltage:	24 V DC (+10%)				
- max. current drain:	approx. 15mA				
- short circuit/overload:	LED output				
- connection cable:	Ref.no.: VK_JST025BKL, VK_JST034				
Norms and Standards					
IEC62026-2, IEC60204-1, IEC61508, EN418, IEC60947-5-5, EN ISO 13849-1:2006					
AS-i certificates:	62801, 62802				
TÜV Type Approval Certificate:	available				
Data Bits					
Output *1		Inputs			
Data Bit	Info (Interface 3)	state	Data Bit	Info (Interface 3)	state
D0	0	off	D0...D3	acc. to profile S-7.B.E*1, S-0.B.E	
	1	on			

*1) refers only to the types ASI_SAW16A, ASI_SAW22A

*2) refers only to the types ASI_SAW16A, ASI_SAW22A (with additional addressing jack)



Operating Instructions

(Translation of the orig. Operating Instructions)

AS-Interface Emergency-Stop Slave Safety at Work

ASI_SAW16A, ASI_SAW16E
ASI_SAW22A, ASI_SAW22E



Installation: ASI_SAW16(A), ASI_SAW22(A)

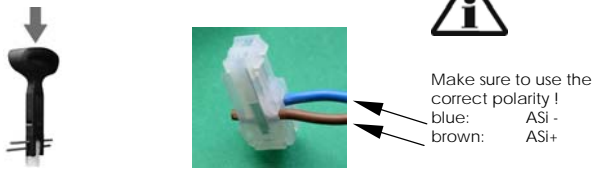

Put slave and E-STOP together

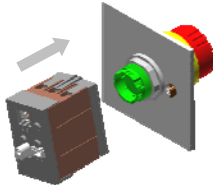

... and snap them into place by a clockwise rotation

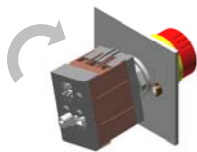

Connection to AS-Interface via a 2-pole connector

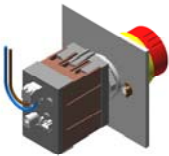

optional:
Connection of the E-Stop lighting via the connection cable

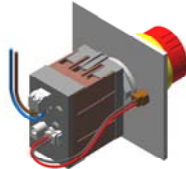

Insatallation: ASI_SAW16E, ASI_SAW22E

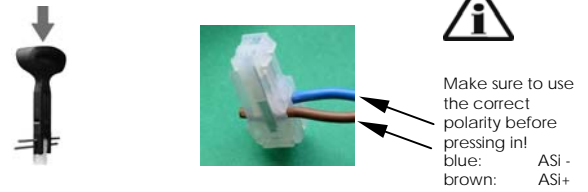

Put slave and E-STOP together

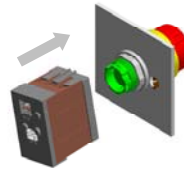

... and snap them into place by a clockwise rotation



Connection to AS-Interface via a 2-pole connector



Dimensional Drawings: (all dimensions in mm)

16mm models: ASI_SAW16A, ASI_SAW16E

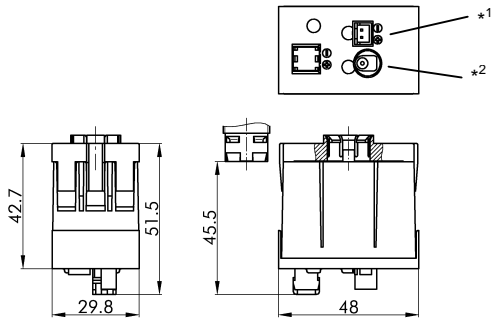

22mm models: ASI_SAW22A, ASI_SAW22E

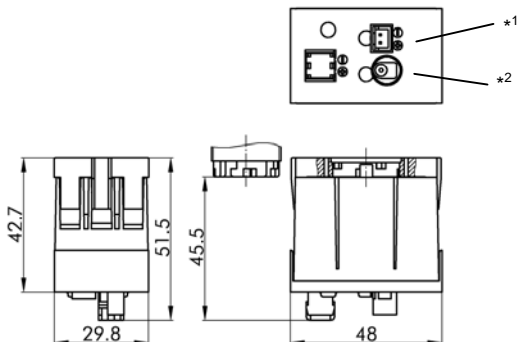

Models and Accessories

Ref. No.	Description
ASI_SAW16E	AS-I safety slave for E-STOP (16 mm mounting dia.)
ASI_SAW22E	AS-I safety slave for E-STOP actuators (22 mm mounting dia.)
ASI_SAW16A	AS-I safety slave for E-STOP actuators (16 mm mounting dia.), with safety shutdown, addressing jack and digital output
ASI_SAW22A	AS-I safety slave for E-STOP actuators (22 mm mounting dia.), with safety shutdown, addressing jack and digital output
VK_JST025BKL	Connecting cable between dig. output of ASI_SAW16(A), ASI_SAW22(A) and E-STOP actuators with illuminated anti-lock collar, length approx. 10 cm
VK_JST034	Connecting cable between dig. Output of ASI_SAW16(A), ASI_SAW22(A) and e.g. an external pilot light: open end, length approx.. 10cm
ASI_MRT	Hand tool to press the single conductors "ASI_SL2AWG18" into the IDC connector "ASI_SB2AWG18"
ASI_PK500M12	Addressing cable to address the slaves with commercial AS-I hand addressing device!
ASI_SL2AWG18	Flexible equipment wire, 2-core cable, brown/blue, to connect the slaves to the AS-Interface by insulation piercing.
LA9Z-SNTB	Flat cable branch, transition from the flexible equipment wire "ASI_SL2AWG18" to the yellow AS-I profile line

*1) refers only to the types ASI_SAW16A, ASI_SAW22A

*2) refers only to the types ASI_SAW16A, ASI_SAW22A (with additional addressing jack)