

Mounting and Installation Instructions

789-601 4 Channel Radio Receiver with Normally Open Contacts; 230V~ / 16A

789-602 4 Channel Radio Receiver with Change Over Contacts; 230V~ / 8A

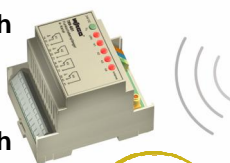

Features

- Radio Receiver for Battery and Wireless Sensors
- Status indication via LED
- 868 MHz Frequency band
- Transmitter / Receiver assignment via Learn-Mode
- 4 potentialfree contacts
- Invertable Outputs; Switch or Toggle beviour selectable
- Supply voltage 24V DC
- External Antenna for optimized Transmission Range (always required)
- CAGE-CLAMP® terminals

1. General Description

The Radio Receivers in the modular installation housing is designed for switching of 4 individual loads (e.g. lamps) via radio sensors and push-buttons which are based on EnOcean Radio Technology. Transmission is on a european-wide harmonized transmission band of 868 MHz. The system is specially dedicated for flexible, pluggable building or industrial automation because the expenditure for new or reconfiguring of installations is minimized.

Compatibility: The Radio Receiver is compatible to wireless sensors of different manufacturers. The sensors must be based on EnOcean PTM or STM transmitters (see chapter 8.3).

Transmitter - Receiver - Assignment: One receiver could be operated from up to 40 transmitters, each channel from up to 10 transmitters. The assignment between sensor and output has to be taught once during commissioning, the assignments are stored mains-failure protected in the NV-Ram of the Receiver. Mixed operation of PTM and STM Modules is possible. One sensor could be assigned to multiple outputs (1:n); multiple transmitters could be assigned to one output channel (n:1).

Output Contacts: Loads are operated via 4 relays with normally-open or change over contacts. The max. permissible load per contact is either 8A (789-602) or 16A (789-601).

2. Front-View and Operating Elements

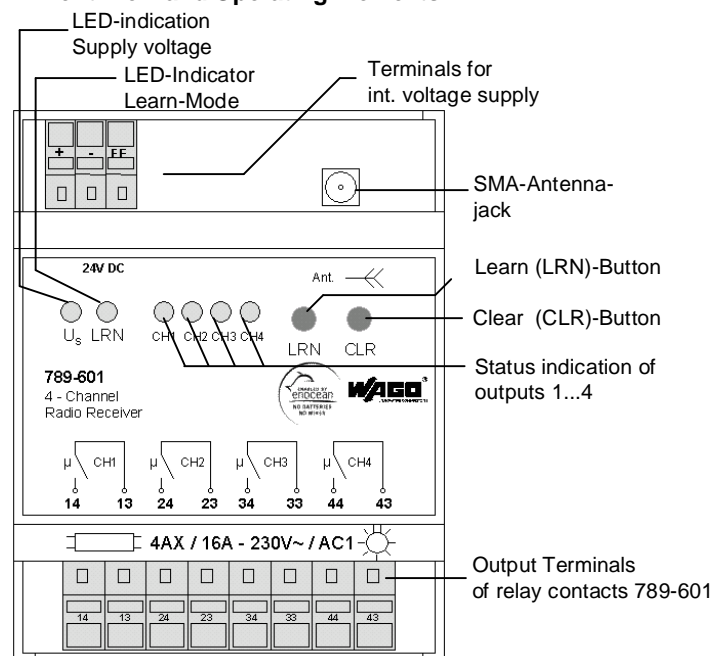

3. Restrictions and Regulations

3.1 Legal Regulations



The following topics should be observed:

- the valid laws, norms and regulations
- the applicable local codes in respect to wiring practices
- the state of the technology at time of installation
- the operating manual from sensors and receiver
- the general rules of the technique
- the fact, that instructions manuals could only inform about general regulations and these have to correspond with plant or local regulations.

3.1 Restrictions for the Operation of Radio Transmitters or Receivers

The use of the devices does not need to be registered and is free in the European Union, Switzerland, Cyprus, the Czech Republic, Poland and in Slovenia.

The use in other countries requires explicit clarification!

4. Advice for Safety



! Danger for Life existing in case of open unit by electrical power !

Electrical connection, mounting and dismantling is only allowed by qualified electrical personal.

Switch Off mains/power connectors before mounting or dismantling of the Radio Receiver.

Observe assignment of the connectors.

Wrong wiring may destroy the device or lead to short circuits.

Failure to observe these precautions could result in severe bodily injury or loss of life.

5. Commissioning

Before commissioning the receiver should be proofed for mechanical- or transport-damages. In case of probable damages the commissioning of the unit is not allowed. Read the instruction manual carefully and observe the technical advices and applying legal regulations.

5.1 Handling Advices / ESD (Electrostatic Discharge)



The modules are equipped with electronic components that may be destroyed by electrostatic discharge. When handling the modules, ensure that the environment (persons, workplace and packing) is well grounded. Avoid touching of conductive components.

5.2. General Advices for Installation

Avoid installing the module, the antenna and the antenna line close to sources of transient interferences, such as fluorescent tubes with defective starter, frequency converters and power cables. As a result, communication failures may occur leading to faulty output behavior.

5.3 Advices for Antenna Installation

Use only appropriate antenna (WAGO 758-910 incl. 2.5 m RG174-cable and SMA-connector; see accessories). Antenna must be mounted on metal footer with min. dimensions of 25 cm x 25 cm. Antenna including cable must have min 30 cm distance to interference sources and antenna should have free space to walls of min. 35 cm. The cable must not be bended because the cable may be damaged (RG174 bending radius > 15 mm).

5.4 Preconditions for Commissioning

Before commissioning the supply voltage must be applied and the external antenna must be connected.

Switches (Transmitters) should be „learned“ before mounting, because of reduced transmission range (appr. 5 m) in Learn-Mode.

5.5 Please observe the following Advices before activating the Learn-Mode!



The sensitivity of the receiver is reduced to appr. 5 m as long as Learn-Mode is active.

In Learn-Mode the relay outputs are triggered cyclically in parallel to the indication of the status LEDs. If this behavior is not allowed in the application, the loads must be disconnected be means of the output terminals to assure no risk for health. When activating the Learn-Mode the former state of outputs is stored and will be activated again when leaving the Learn-Mode.

5.6 Teaching of Transmitters / Learn (LRN) Button

Operating-state:

- ⇒ Receive-Mode; LED Us ON
- or additionally
- ⇒ LED „LRN“ flashes; no transmitter assigned

1. Switch receiver into LRN-Mode
 - ⇒ Press LRN at the receiver
 - ⇒ LRN active - LED „LRN“ ON
 - ⇒ 1. Channel-LED flashes
2. Select channel for teaching
 - ⇒ Press LRN at the receiver
 - ⇒ Next / selected channel LED flashes
3. Operate Radio Transmitter / Switch (submit telegram)
 - ⇒ Channel LED for 4 seconds ON
 - ⇒ Selected channel LED flashes again; further transmitters could be taught on this channel
 - ⇒ Receiver leaves LRN-Mode LED „LRN“ OFF

alternative:

- ⇒ further flashing of Channel LED
- ⇒ wait appr. 5 seconds
- ⇒ Operate transmitter / switch again
- ⇒ Channel LED for 4 seconds ON
- ⇒ Receiver leaves LRN-Mode; LED „LRN“ OFF

5.7 Exit LRN-Mode

1. Automatically after learning or deleting of transmitters
 - ⇒ Receiver switches off LRN-Mode LED „LRN“ OFF
- Learn-Mode is deactivated after 30 s automatically; no operation required.
 - ⇒ Receiver switches off LRN-Mode LED „LRN“ OFF
- Leaving via LRN-Button
 - ⇒ multiple operation of LRN-button
 - ⇒ Receiver leaves LRN-Mode (after channel 4) LED „LRN“ OFF

5.8 Selective Deleting of single Transmitter / LRN Button
Please observe, the transmission range is reduced to appr. 5 mtrs, even if transmitters should be deleted!

1. Switch Receiver into LRN-Mode
 - ⇒ Press LRN-Button
 - ⇒ LRN-Mode active - LED „LRN“ ON
 - ⇒ LED of 1. Channel flashes
2. Select channel to be „unlearned“
 - ⇒ Press LRN-Button again
 - ⇒ LED of next channel flashes
3. Operate button / switch on transmitter (submit telegramm)
 - ⇒ LED of sel. Channel is 4s OFF
 - ⇒ Receiver leaves LRN-Mode LED „LRN“ OFF

alternative:

- ⇒ further flashing of Channel LED
- ⇒ wait appr. 5 seconds
- ⇒ Operate transmitter / switch again
- ⇒ Channel LED for 4 seconds ON
- ⇒ Receiver leaves LRN-Mode; LED „LRN“ OFF

5.9 Deleting Assignment of all Transmitters / CLR-Button
By pressing the CLR-Button ALL previously assigned transmitters are deleted.

- ⇒ Press CLR Button
- ⇒ LED „LRN“ flashes (0.5 Hz); no transmitters assigned

6. Changing Mode of Operation (from software 02)

In state of delivery, the “Switching-Mode” is active. For changing of the behaviour, the LRN button must be pressed for ~2s during Power-Up. All 5s the following mode of operation is selected (indicated by LED K1...4). To activate the selected function the LRN Button must be pressed within 5s (signalled with 8Hz flashing light of selected function LED. To activate selected Function, press LRN-Button again, receiver activates selected function and switches to Receive-Mode.

Signalisation of Operating-Mode (LED flashes):

K1= Switching-Mode; K2= Toggle-Mode; K3= Inverted Output behaviour; K4=State of output at Power ON
 K4+K1=Switching-Mode 2-channel PTM230 (from software 03);
 K4+K2= Toggle-Mode 2-channel PTM230 (from software 03)
 State of delivery of versions 789-60x/001-000 is Toggle-Mode.

7. Transmission Behavior

Commands from transmitters will take about 40 to 70ms for transmission, which is based on the EnOcean Radio Technology on the 868Mhz band. With the further processing in the Wago receiver the delay between operation and execution of the command will be up to 100ms.

8. Terminal Assignments

8. 1 Input / Voltage-Supply

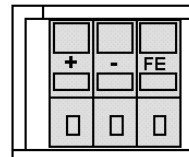

Pin	Determination
+	Plus (24V)
-	Gnd
FE	functional earth

FE should be grounded with wiring as short as possible.

8.2 Output / NO Contacts 789-601

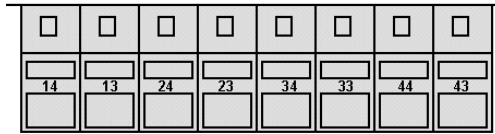

Pin no.	Determination
13, 14	NO Contact Ch. 1
23, 24	NO Contact Ch. 2
33, 34	NO Contact Ch. 3
43, 44	NO Contact Ch. 4

8.3 Output / CO Contacts 789-602

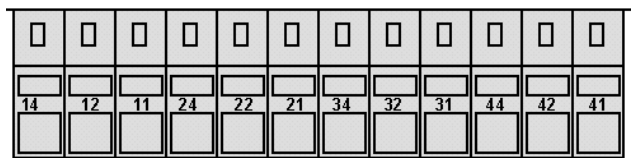

Pin no.	Determination
11, 12, 14	CO Contacts Ch. 1
21, 22, 24	CO Contacts Ch. 2
31, 32, 34	CO Contacts Ch. 3
41, 42, 44	CO Contacts Ch. 4

9. Technical Data

Designation	Data	
Item-no.	789-601	789-602
Supply voltage	DC24V -15/+20%	
Current consumption (internal)	Max. 90mA	
No. of channels / outputs	4	
No. Of receive-channels	40 / 10 per output	
Max sw itching frequency.	5 Hz	
Delay-time (Transmitter / output command)	< 100ms typ. 40...70ms	
Type of contacts	NO contacts	CO contacts
Sw itching voltage	230V ~	
Fusing of Loads	Wire breaker; max. 16A	
Output current (per Channel)	max. 16A, AC1	max. 8A, AC1
Type of load	see table 8.1	
Potential bonding		
Supply / Antenna	-	
Supply / Contacts	4 kV eff.	
Channel / Channel	2,2 kV eff.	
Open Contacts	1 kV eff.	
Ambient temperature	0 ... +55°C	
Storage temperature	-25 ... + 85°C	
Relative humidity	85% without condensation	
Degree of pollution	2	
Degree of protection	IP20	
Mounting position	optional	
Terminals	WAGO CAGE-CLAMP (R) Series 236	
Stripping length	5 - 6 mm	
Housing	Modular Installation Housing	
Mounting	DIN Rail acc. EN 50022	
Dimensions (w x h x d)	appr. 70 x 90 x 55 mm	
Approvals	KEMA; acc. EN 60669-2-1:1996	

9.1 Max. permissible Load acc. to EN60669-2-1

Type of load	Product Type	
	789-601	789-602
halogen lamps	1400W	1400W
incandescent lamps	2200W	1840W
iron-core transformer	120VA	120VA
fluorescent lamps	4AX	-
capazitive loads	60µF	-
motorload	2A	2A

9.2 Max. DC Load Breaking Capacity

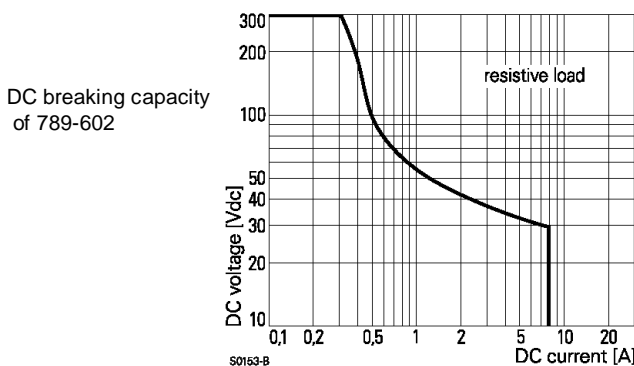
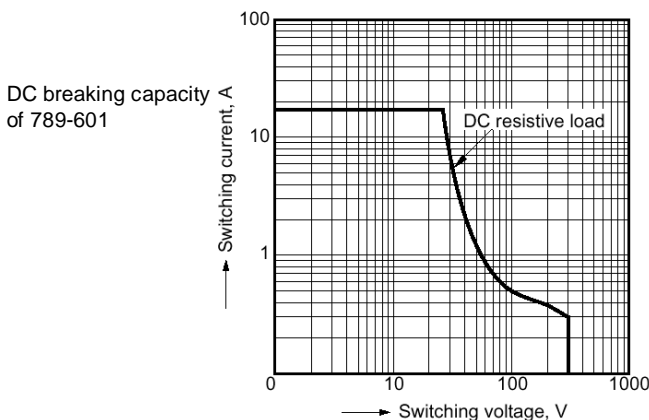

9.3 Data Processing of PTM / STM Data

The Radio Receiver is analyzing binary data from different types of radio transmitters which are based on the EnOcean Radio Techno-logy. From following type of modules data could be processed:

Module type	EnOcean	Application
PTM 100, 200, 230		push-buttons
STM250		window-contacts
STM100		industrial sensors / switches

From the data telegrams the following bits are used:

Des. EnOcean	Org-Byte	Typ	Data-Byte	Bit
PTM100	5	RPS	3	4...7
PTM200	5	RPS	3	4...7
PTM230	5	RPS	3	4...7
STM100	7	4BS	0	0
STM250	6	1BS	3	0

10. Accessories

Antenna: WAGO 758-910 incl. 2.5 m RG174-cable and SMA-Connector.

11. General Advices for EnOcean Radio Technology

11.1 Safety Advices conc. R&TTE: Danger



The radio receiver modules must not be used in any relation with equipment that supports, directly or indirectly, human health or life or with applications that can result in danger for people, animals or real value.

This results from the classification of the radio receiver module in "Class 2 Equipment" according to ETSI EN 301 489-3 V1.4.1 (2202-08) "Specific conditions for short-range devices (SRD)".

11.2 Details for Transmission Range

The transmission ranges are mainly depending on mounting and positioning as well as type of material which is used in buildings. The type of used materials and thickness of walls have a main influence to the quality and the strength of radio data.

It is recommended to make tests of data transmission at desired mounting positions before installation.

11.3 Typical max. Transmission Ranges

- 1) Visual contacts: typ. 30 m in passages, up to 100 m in halls
 - 2) Rigypsum walls/ wood: typ. 30 m range through max. 5 walls
 - 3) Brick wall /Gas concrete: typ. 20 m range through max. 3 walls
 - 4) reinforceds concrete /-ceiling: typ. 10 m range through max. 1 wall
- Supply blocks and lift shafts should be seen as a compartmentalisation.

11.4 Reduction of Transmission Range

Restriction of the transmission range can also be due to:

- Hollow lightweight walls with insulating wool on metal foil
- suspend ceilings with panels made of metal
- carbon fiber, lead glass or glass with metal coating, metal furniture
- metal wall mounting of the switch.

In addition, the angle with which the signal arrives at the wall is of great importance. Depending on the angle, the effective wall strength and thus the damping attenuation of the signal changes. If possible, the signals should run vertically through the walling. Walling recesses should be avoided.

For mounting and installation of transmitters please observe additionally the advices provided by the manufacturer!

12. EC Certificates of Conformity



EC Certificate of Conformity

Document No. : 78960101
Month/Year: 06/05

This is to certify that the product designated hereunder conforms to the requirements, which are defined in the directive of the council for adaptation of the member states' legal prescriptions on radio equipment and telecommunications terminal equipment and the mutual recognition of their conformity (1999/5/EG).

789-601

The following standards have been applied to check the electromagnetic compatibility of the product:

EN61000-6-2 (01/99)
 ETSI EN 301 489-1 (09/01)
 ETSI EN 301 489-3 (11/01)
 ETSI EN 300 220-3 (09/00)

This declaration is valid for the manufacturer/authorized representative

(Name) WAGO Kontakttechnik GmbH
 (Address) Hansastr.27
32423 Minden

made by

(Surname, name) Dr. Thomas Albers
 Position (Title) of the manufacturer Technical director electronics

(Date) Minden, 15th of June 2005
(Signature bearing signature)

This declaration certifies compliance with the indicated directives but implies no warranty of properties.

The safety instructions of the accompanying product documentation shall be observed.



EC Certificate of Conformity

Document No. : 78960201
Month/Year: 06/05

This is to certify that the product designated hereunder conforms to the requirements, which are defined in the directive of the council for adaptation of the member states' legal prescriptions on radio equipment and telecommunications terminal equipment and the mutual recognition of their conformity (1999/5/EG).

789-602

The following standards have been applied to check the electromagnetic compatibility of the product:

EN61000-6-2 (01/99)
 ETSI EN 301 489-1 (09/01)
 ETSI EN 301 489-3 (11/01)
 ETSI EN 300 220-3 (09/00)

This declaration is valid for the manufacturer/authorized representative

(Name) WAGO Kontakttechnik GmbH
 (Address) Hansastr.27
32423 Minden

made by

(Surname, name) Dr. Thomas Albers
 Position (Title) of the manufacturer Technical director electronics

(Date) Minden, 15th of June 2005
(Signature bearing signature)

This declaration certifies compliance with the indicated directives but implies no warranty of properties.

The safety instructions of the accompanying product documentation shall be observed.