

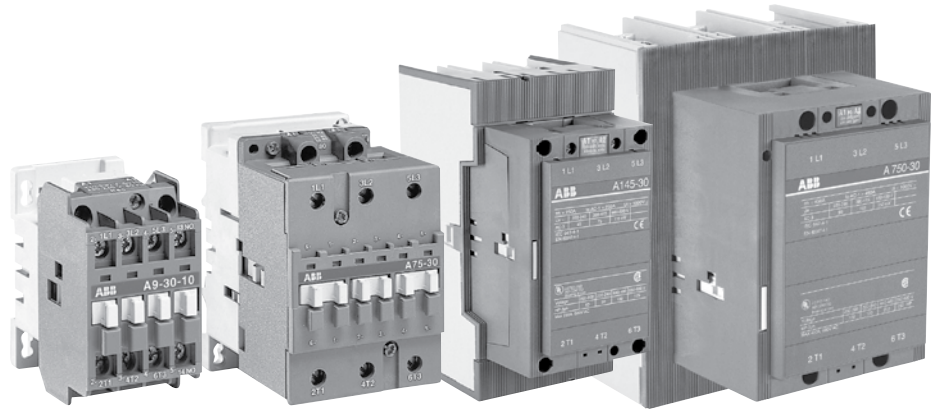

Across the line contactors A9 - AF1650

1



Across the line Contactors

A9 - A110

- Maximum UL/CSA horsepower ratings according to UL508 and CSA22.2 No. 14
- Includes NEMA sizes 00 - 3
- CE mark
- Compact space saving design
- Standard auxiliary contact configurations:
 - A9 - A40 1 NO or 1 NC
 - A50 - A110 1 NO & 1 NC
- Contactor sizes A50 - A110 can be supplied without auxiliaries
- Additional auxiliary contact blocks are available
- D.C. ratings & D.C. control operation available
- Fast, snap-on DIN rail mounting
- Double break contact design
- Snap-on front mounted accessories include mechanical latch, pneumatic timer, and 1 & 4 pole auxiliary contact blocks
- Contactors ensure positive safety between their auxiliary contact blocks.
- Easy coil change
- Captive terminal screws
- NEMA, UL, IEC, CSA, VDE and most other international standards
- Touch safe design: All connection terminals are protected against accidental touch
- Terminals supplied open for ease of wiring
- Operates over an extended voltage range of 85% to 110% of rated control voltage
- Screwdriver guide holes
- UL File No: E39231 (A9 - A75); (AE9 - AE75); (AL9 - AL40); (AF50 - AF75)
- UL File No: E36588 (A95 - A110); (AE95 - AE110); (AF145 - AF750)
- CSA File No: LR56745 (A9 - A75); (AE9 - AE75); (AF50 - AF75)
- CSA File No: LR19700 (A95 - A110); (AE95 - AE110); (AF145 - AF750)
- CSA approved for elevator service

A145 - AF1650

- Maximum UL/CSA horsepower ratings according to UL508 and CSA22.2 No. 14
- Includes NEMA sizes 4 - 8
- CE mark
- 1 NO & 1 NC auxiliary contacts are standard and up to 6 additional auxiliary contacts may be added to provide a total of 8 (4 NO & 4 NC)
- Contactors ensure positive safety between their auxiliary contact blocks.
- D.C. ratings and D.C. control operation available
- Easy maintenance of main contacts and coil inspection
- Can be mounted in any position
- Terminal lugs sold separately. See page 1.25.
- Operates over an extended voltage range of 85% to 110% of rated control voltage
- NEMA, UL, IEC, CSA, VDE and most other international standards
- UL File No: E36588 (A/AF145 - AF750)
- UL File No: E73397 (AF1350 - AF1650)
- CSA File No: LR19700

A9 - A300

General information

AC operated, UL rated, 3 phase

Application

A-Line contactors are mainly used for controlling 3-phase motors and for controlling power circuits corresponding to their operating characteristics up to 690 and even 1000 VAC, and 440 VDC.

Description of 3 pole and 4 pole contactors A9 - A300

All A-Line contactors can be assembled side by side. The add-on or built-in auxiliary contacts are suitable for low level currents.

Control circuit types

- A-Line types: AC operated with laminated magnetic circuit.

Contactor types

- 3 pole contactors with NO or NC built in auxiliary contact for A9 - A40 contactors; factory assembled auxiliary contacts for A50 - A300 contactors
- 4 pole contactors: 4 NO or 2 NO & 2 NC without any auxiliary contacts. (A9 - A75)

Quick mounting on DIN rail: EN 50022 and EN 50023 standards:

35 x 7.5mm for A9 - A40

35 x 15mm for A9 - A75

75mm for A45 - A110

Location of side mounted accessories: on right or left hand side. Factory mounted on left hand side for CAL5 on A50 - A300

Holes for screw mounting (screws not supplied). Distance between holes according to EN 50003.

Terminals in A9 - A110 contactors are delivered in open position with captive screws (screws of unused terminals must be tightened).

Screwdriver guidance for all terminals makes it possible to use motorized screwdrivers.

All terminals provide protection against accidental direct contact with live parts according to VDE0106 - Part. 100.

All A9 - A40 contactor terminals as well as A45 - A300 contactor auxiliary contact and coil terminals ensure IP20 degree of protection according to IEC 947-1.

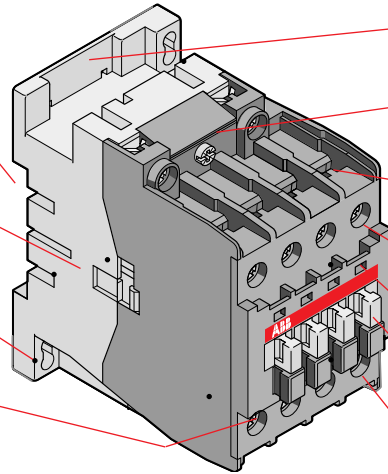

A9 - A300

Location of surge suppressors.

Clear marking of coil voltages and frequencies.

Connecting point for control leads in top part of main terminals of A50 - A75 contactors. For A95 & A110 contactors these are additional power connections.

Terminal marking according to IEC 947-4-1, EN 50005, EN 50012 and NEMA standards.

Location of function marker.

Stops for attaching front mounted accessories.

Terminal screws:

- Posidrive (+,-) No 2 for all A9 - A75
- M8 hex threaded socket screw for A95 - A300 main terminals.

Catalog number explanation

A9-30-10-84

Frame size

Power pole

30 = 3 NO

40 = 4 NO

22 = 2 NO & 2 NC

Coil voltage

(see coil voltage selection chart)

Auxiliary contacts

10 = 1 NO & 0 NC

01 = 0 NO & 1 NC

11 = 1 NO & 1 NC

00 = No auxiliary provided

22 = 2 NO & 2 NC

Coil voltage selection chart

Hz	Cntr type	Volts															
		12	24	48	110	120	125	208	220	240	277	380	415	440	480	500	600
60	A		81	83	84	84		34	36	80	42		86	86	51	53	55
50	A		81	83	84				80			85	86			55	

For other voltages, see page 1.24.

A9 - A300

Non-reversing, mechanically interlocked, reversing
AC operated, UL rated, 3 phase

Across the line
contactors



A26-30-10-84

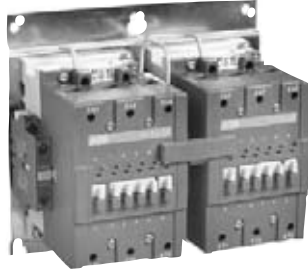

A110M-30-11-84

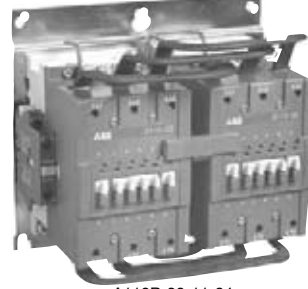

A110R-30-11-84

UL general purpose current	UL motor switching current	Maximum motor horsepower ratings				Standard Aux. contacts		Non-reversing		Mechanically interlocked		Reversing	
		208V	240V	480V	575/600V	NO	NC	Catalog number	List price	Catalog number	List price	Catalog number	List price
UL rated													
AC1													
21	9	2	2	5	7.5	1 0	0 1	A9-30-10-84 A9-30-01-84	\$ 78	A9M-30-10-84 A9M-30-01-84	\$ 255	A9R-30-10-84 A9R-30-01-84	\$ 315
25	11	3	3	7.5	10	1 0	0 1	A12-30-10-84 A12-30-01-84	84	A12M-30-10-84 A12M-30-01-84	315	A12R-30-10-84 A12R-30-01-84	375
30	17	5	5	10	15	1 0	0 1	A16-30-10-84 A16-30-01-84	102	A16M-30-10-84 A16M-30-01-84	345	A16R-30-10-84 A16R-30-01-84	413
40	28	7.5	10	20	25	1 0	0 1	A26-30-10-84 A26-30-01-84	183	A26M-30-10-84 A26M-30-01-84	405	A26R-30-10-84 A26R-30-01-84	480
50	34	10	10	25	30	1 0	0 1	A30-30-10-84 A30-30-01-84	252	A30M-30-10-84 A30M-30-01-84	548	A30R-30-10-84 A30R-30-01-84	623
60	42	10	15	30	40	1 0	0 1	A40-30-10-84 A40-30-01-84	297	A40M-30-10-84 A40M-30-01-84	639	A40R-30-10-84 A40R-30-01-84	750
80	54	15	20	40	50	1	1	A50-30-11-84	330	A50M-30-11-84	713	A50R-30-11-84	810
90	65	20	25	50	60	1	1	A63-30-11-84	372	A63M-30-11-84	870	A63R-30-11-84	1,013
105	80	25	30	60	75	1	1	A75-30-11-84	413	A75M-30-11-84	1,155	A75R-30-11-84	1,298
125	95	30	30	60	75	1	1	A95-30-11-84	450	A95M-30-11-84	1,230	A95R-30-11-84	1,425
140	110	30	40	75	100	1	1	A110-30-11-84	480	A110M-30-11-84	1,365	A110R-30-11-84	1,628
230	130	40	50	100	125	1	1	A145-30-11-84	825	A145M-30-11-84	2,235	A145R-30-11-84	2,250
250	156	50	60	125	150	1	1	A185-30-11-84	1,290	A185M-30-11-84	3,360	A185R-30-11-84	3,375
300	192	60	75	150	200	1	1	A210-30-11-84	1,635	A210M-30-11-84	4,035	A210R-30-11-84	4,050
350	248	75	100	200	250	1	1	A260-30-11-84	1,815	A260M-30-11-84	4,485	A260R-30-11-84	4,500
400	302	100	100	250	300	1	1	A300-30-11-84	1,875	A300M-30-11-84	5,460	A300R-30-11-84	5,475
550	414	125	150	350	400	1	1						
650	480	150	200	400	500	1	1						
750	602	200	250	500	600	1	1						
900	810	250	300	600	700	1	1						
1350	960	—	400	800	900	1	1						
1650	1080	—	450	900	1000	1	1						

See Type AF contactors, page 1.9

Coil voltage selection

All AC operated catalog numbers include a 120VAC coil. To select other coil voltages, substitute the code from the Coil Voltage Selection Chart for the two digits after the last dash in the catalog number.

Ex.: A 240V coil is required for an A75 contactor: A75-30-11-80

Auxiliary contact blocks

For additional auxiliary contact blocks, see catalog number explanation on page 1.2. Add \$ 20 to list price for each additional auxiliary, and see page 1.32 for available combinations. Only side-mounted blocks are allowed to be factory installed. If auxiliary contacts are not required for A50 - A300, subtract \$ 40 from list price and change catalog number to "00" instead of "11."

Mechanical interlock

Mechanically interlocked contactors are designed for reversing, 2 speed, reduced voltage, etc. type starter applications. The complete assembly consists of two mechanically and electrically interlocked contactors mounted as follows with line and load terminals:

- A9 - A16 — mounted on 35mm DIN rail
- A26 - A300 — mounted on common baseplate

Power wiring is not included. The NC electrical interlock is provided with the mechanical interlock for A9 - A110 contactors.

Coil voltage selection chart

Hz	Cntr type	Volts															
		12	24	48	110	120	125	208	220	240	277	380	415	440	480	500	600
60	A	81	83	84	84		34	36	80	42		86	86	51	53	55	
50	A	81	83	84				80				85	86			55	

For other voltages, see page 1.24.

Reversing

Reversing contactors are designed for reversing type starter applications. The complete assembly consists of two mechanically and electrically interlocked contactors mounted as follows with line and load terminals:

- A9 - A16 — mounted on 35mm DIN rail
- A26 - A300 — mounted on common baseplate

The NC electrical interlock is provided with the mechanical interlock for A9 - A110 contactors.

AE9 - AE110

General information

DC operated, UL rated, 3 phase

Application

A-Line contactors are mainly used for controlling 3-phase motors and for controlling power circuits corresponding to their operating characteristics up to 690 and even 1000 VAC. and 440 VDC.

Control circuit types

AE types: with laminated magnetic circuit and double-winding coil fed from DC supply via a CDL5 insertion contact mounted on the device. The CDL5 has an NC lagging contact for insertion of the second winding. (See schematic.)

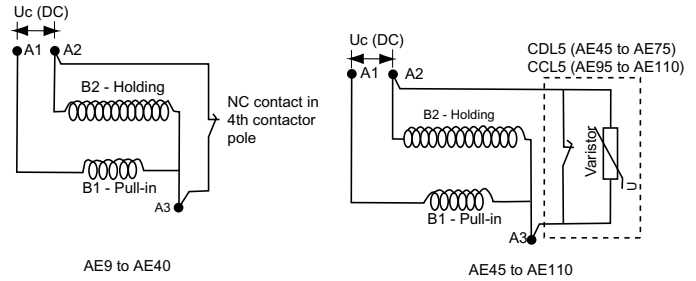

Quick mounting on DIN rail: EN 50022 and EN 50023 standards:

- 35 x 7.5mm for AE9 - AE40
- 35 x 15mm for AE9 - AE75
- 75mm for AE45 - AE110

Location of side mounted accessories: on right or left hand side. Factory mounted on left hand side for CAL5 on A50 - A300

- right hand side for CDL5/CCL5 on AE45 - AE110

Holes for screw mounting (screws not supplied). Distance between holes according to EN 50003.

Terminals delivered in open position with captive screws (unused terminal screws must be tightened).

Screwdriver guidance for all terminals makes it possible to use motorized screwdrivers.

All terminals provide protection against accidental direct contact with live parts according to VDE0106 - Part. 100.

All AE9 - AE40 contactor terminals as well as AE45 - AE110 contactor auxiliary contact and coil terminals ensure IP20 degree of protection according to IEC 947-1.

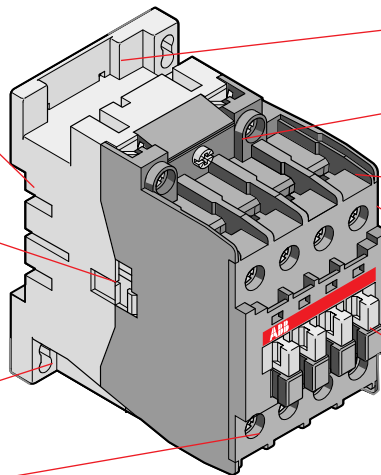

AE9 - AE110

Location of surge suppressors.

Clear marking of coil voltages and frequencies.

Connecting point for control leads in top part of main terminals of AE50 - AE75 contactors. For AE95 & AE110 contactors these are additional power connections.

Terminal marking according to IEC 947-4-1, EN 50005, EN 50012 and NEMA standards.

Location of function marker.

Stops for attaching front mounted accessories.

Terminal screws:

- Posidrive (+,-) No° 2 for all AE9 - AE75
- M8 hex threaded socket screw for AE95 & AE110

Catalog number explanation

AE9-30-00-81

Frame size

Power pole

- 30 = 3 NO
- 40 = 4 NO
- 22 = 2 NO & 2 NC

Coil voltage

(see coil voltage selection chart)

Auxiliary contacts

- 00 = No auxiliary provided
- 11 = 1 NO & 1 NC

Coil voltage selection chart

Hz	Contr. type	Volts						
		12	24	48	110	125	220	240
DC	AE	80	81	83	86	87	88	89

For other voltages, see page 1.24.

AE9 - AE110

Non-reversing, mechanically interlocked, reversing
DC operated, UL rated, 3 phase

Across the line
contactors

1



AE26-30-11-81



AE110M-30-11-81

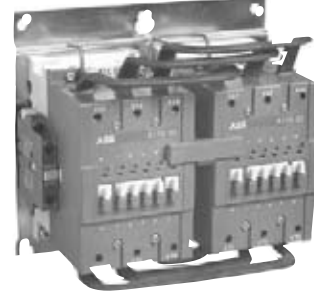

AE110R-30-11-81

General purpose current	UL motor switching current	Maximum motor horsepower ratings				Standard Aux. contacts		Non-reversing		Mechanically interlocked		Reversing	
		208V	240V	480V	575/600V	NO	NC	Catalog number	List price	Catalog number	List price	Catalog number	List price
UL rated													
AC1													
21	9	2	2	5	7.5	1	1	AE9-30-11-81	\$ 118	AE9M-30-11-81	\$ 335	AE9R-30-11-81	\$ 395
25	11	3	3	7.5	10	1	1	AE12-30-11-81	124	AE12M-30-11-81	395	AE12R-30-11-81	455
30	17	5	5	10	15	1	1	AE16-30-11-81	142	AE16M-30-11-81	425	AE16R-30-11-81	493
40	28	7.5	10	20	25	1	1	AE26-30-11-81	223	AE26M-30-11-81	485	AE26R-30-11-81	560
50	34	10	10	25	30	1	1	AE30-30-11-81	292	AE30M-30-11-81	628	AE30R-30-11-81	703
60	42	10	15	30	40	1	1	AE40-30-11-81	337	AE40M-30-11-81	720	AE40R-30-11-81	830
80	54	15	20	40	50	1	1	AE50-30-11-81	375	AE50M-30-11-81	803	AE50R-30-11-81	930
90	65	20	25	50	60	1	1	AE63-30-11-81	477	AE63M-30-11-81	1,080	AE63R-30-11-81	1,208
105	80	25	30	60	75	1	1	AE75-30-11-81	518	AE75M-30-11-81	1,365	AE75R-30-11-81	1,493
125	95	30	30	60	75	1	1	AE95-30-11-81	555	AE95M-30-11-81	1,440	AE95R-30-11-81	1,635
140	110	30	40	75	100	1	1	AE110-30-11-81	690	AE110M-30-11-81	1,785	AE110R-30-11-81	2,048
230	130	40	50	100	125	1	1						
250	156	50	60	125	150	1	1						
300	192	60	75	150	200	1	1						
350	248	75	100	200	250	1	1						
400	302	100	100	250	300	1	1						
550	414	125	150	350	400	1	1						
650	480	150	200	400	500	1	1						
750	602	200	250	500	600	1	1						
900	810	250	300	600	700	1	1						
1350	960	—	400	800	900	1	1						
1650	1080	—	450	900	1000	1	1						

See AF contactors, page 1.9

Coil voltage selection

All DC operated catalog numbers include a 24VDC coil. To select other coil voltages, substitute the code from the Coil Voltage Selection Chart for the two digits after the last dash in the catalog number.

Ex.: A 110V coil is required for an AE75 contactor: AE75-30-11-86

Auxiliary contact blocks

For additional auxiliary contact blocks, see catalog number explanation on page 1.4. Add \$ 20 to list price for each additional auxiliary, and see page 1.32 for available combinations.

Mechanical interlock

Mechanically interlocked contactors are designed for reversing, 2 speed, reduced voltage, etc. type starter applications. The complete assembly consists of two mechanically and electrically interlocked contactors mounted as follows with line and load terminals:

- AE9 - AE16 — mounted on 35mm DIN rail
- AE26 - AE110 — mounted on common baseplate

Power wiring is not included.

The NC electrical interlock is provided with the mechanical interlock.

Coil voltage selection chart

Hz	Contr. type	Volts						
		12	24	48	110	125	220	240
DC	AE	80	81	83	86	87	88	89

For other voltages, see page 1.24.

Reversing

Reversing contactors are designed for reversing type starter applications. The complete assembly consists of two mechanically and electrically interlocked contactors mounted as follows with line and load terminals:

- AE9 - AE16 — mounted on 35mm DIN rail
- AE26 - AE110 — mounted on common baseplate

The NC electrical interlock is provided with the mechanical interlock.

AL9 - AL40

General information

DC operated, UL rated, 3 phase

Application

AL and AL...Z contactors are mainly used for controlling 3-phase motors and for controlling power circuits corresponding to their operating characteristics up to 690 and even 1000 VAC, and 440 VDC.

Control circuit types

AL9 - AL40: DC coil with low power consumption of 3W to 3.5W

AL9Z - AL16Z: DC coil with low power consumption of 2.4W. Designed to be directly controlled by PLC.

Quick mounting on DIN rail: EN 50022 and EN 50023 standards:

35 x 7.5mm for AL9 - AL40
35 x 15mm for AL9 - AL40

Location of side mounted accessories: on right or left hand side.

Holes for screw mounting (screws not supplied). Distance between holes according to EN 50003.

Terminals delivered in open position with captive screws (unused terminal screws must be tightened).

Screwdriver guidance for all terminals makes it possible to use motorized screwdrivers.

All terminals provide protection against accidental direct contact with live parts according to VDE0106 - Part. 100.

All AL9 - AL40 contactor terminals as well as contactor auxiliary contacts and coil terminals ensure IP20 degree of protection according to IEC 60947-1.

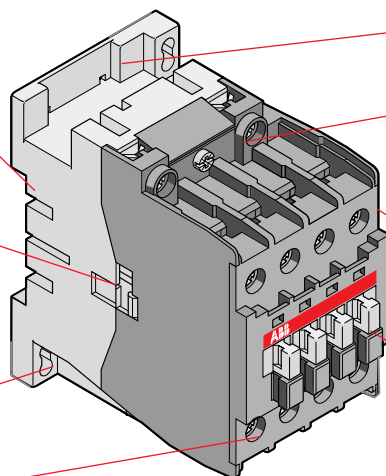

AL9 - AL40

Location of surge suppressors.

Clear marking of coil voltages and frequencies.

Terminal marking according to IEC 60947-4-1, EN 50005, EN 50012 and NEMA standards.

Location of function marker.

Stops for attaching front mounted accessories.

Terminal screws:

- Posidrive (+,-) No° 2 for all AL contactors

Catalog number explanation

AL9 - 30 - 10 - 81

Frame size

Power pole

30 = 3 NO

Coil voltage

(see coil voltage selection chart)

Auxiliary contacts

10 = 1 NO & 0 NC

01 = 0 NO & 1 NC

Coil voltage selection

Hz	Contr. type	Volts						
		12	24	48	110	125	220	240
DC	AL	80	81	83	86	87	88	89
DC	AL...Z		15	28				

For other voltages, see page 1.24.

AL9 - AL40, AL9Z - AL16Z

Non-reversing, mechanically interlocked, reversing DC operated, UL rated, 3 phase

Across the line
contactors

1



AL9-30-10-81



AL26-30-10-81



AL40-30-10-81

AL Contactors – 3W and 3.5W consumption

General purpose current	UL motor switching current	Maximum motor horsepower ratings				Standard Aux. contacts		Non-reversing		Mechanically interlocked		Reversing	
		208V	240V	480V	575/600V	NO	NC	Catalog number	List price	Catalog number	List price	Catalog number	List price
UL rated													
AC1													
21	9	2	2	5	7.5	1 0	0 1	AL9-30-10-81 AL9-30-01-81	\$ 138	AL9M-30-10-81 AL9M-30-01-81	\$ 411	AL9R-30-10-81 AL9R-30-01-81	\$ 433
25	11	3	3	7.5	10	1 0	0 1	AL12-30-10-81 AL12-30-01-81	169	AL12M-30-10-81 AL12M-30-01-81	490	AL12R-30-10-81 AL12R-30-01-81	498
30	17	5	5	10	15	1 0	0 1	AL16-30-10-81 AL16-30-01-81	188	AL16M-30-10-81 AL16M-30-01-81	526	AL16R-30-10-81 AL16R-30-01-81	527
40	28	7.5	10	20	25	1 0	0 1	AL26-30-10-81 AL26-30-01-81	238	AL26M-30-10-81 AL26M-30-01-81	606	AL26R-30-10-81 AL26R-30-01-81	643
50	34	10	10	20	30	1 0	0 1	AL30-30-10-81 AL30-30-01-81	326	AL30M-30-10-81 AL30M-30-01-81	781	AL30R-30-10-81 AL30R-30-01-81	826
60	42	10	15	30	40	1 0	0 1	AL40-30-10-81 AL40-30-01-81	376	AL40M-30-10-81 AL40M-30-01-81	892	AL40R-30-10-81 AL40R-30-01-81	912

ALZ Contactors – 2.4W consumption

General purpose current	UL motor switching current	Maximum motor horsepower ratings				Standard Aux. contacts		Non-reversing		Mechanically interlocked		Reversing	
		208V	240V	480V	575/600V	NO	NC	Catalog number	List price	Catalog number	List price	Catalog number	List price
UL rated													
AC1													
21	9	2	2	5	7.5	1 0	0 1	AL9Z-30-10-15 AL9Z-30-01-15	\$ 141	AL9ZM-30-10-15 AL9ZM-30-01-15	\$ 319	AL9ZR-30-10-15 AL9ZR-30-01-15	\$ 429
25	11	3	3	7.5	10	1 0	0 1	AL12Z-30-10-15 AL12Z-30-01-15	173	AL12ZM-30-10-15 AL12ZM-30-01-15	417	AL12ZR-30-10-15 AL12ZR-30-01-15	477
30	17	5	5	10	15	1 0	0 1	AL16Z-30-10-15 AL16Z-30-01-15	188	AL16ZM-30-10-15 AL16ZM-30-01-15	441	AL16ZR-30-10-15 AL16ZR-30-01-15	501

Coil voltage selection

All DC operated catalog numbers include a 24VDC coil. To select other coil voltages, substitute the code from the Coil Voltage Selection Chart for the two digits after the last dash in the catalog number.

Ex.: A 48V coil is required for an AL30 contactor: AL30-30-10-83

Auxiliary contact blocks

For additional auxiliary contact blocks, see catalog number explanation on page 1.6. Add \$ 20 to list price for each additional auxiliary, and see page 1.32 for available combinations.

Coil voltage selection

Hz	Contr. type	Volts							
		12	24	48	110	125	220	240	
DC	AL	80	81	83	86	87	88	89	
DC	AL...Z		15	28					

For other voltages, see page 1.24.

Mechanical interlock

Mechanically interlocked contactors are designed for reversing, 2 speed, reduced voltage, etc. type starter applications. The complete assembly consists of two mechanically and electrically interlocked contactors mounted as follows with line and load terminals:

- AL9 & AL16 — mounted on 35mm DIN rail
- AL26 & AL40 — mounted on common baseplate

Power wiring is not included.

The NC electrical interlock is provided

Reversing

Reversing contactors are designed for reversing type starter applications. The complete assembly consists of two mechanically and electrically interlocked contactors mounted with line and load terminals.

Ⓞ Only coil voltages available for AL9Z – AL16Z.

AF50 - AF1650

General information

AC & DC operated, UL rated, 3 phase

Application

A-Line contactors are mainly used for controlling 3-phase motors and for controlling power circuits corresponding to their operating characteristics up to 690 and even 1000 VAC, and 440 VDC.

Description of 3 pole contactors AF50 - AF1650

All AF contactors can be assembled side by side. The add-on auxiliary contacts are suitable for low level currents.

Control circuit types

- AF types: AC/DC operated with laminated magnetic circuit.

Contact or types

- 3 pole contactors with 1 NO or 1 NC factory assembled auxiliary contacts for AF50 - AF1650 contactors

Quick mounting on DIN rail: EN 50022 and EN 50023 standards:

35 x 15mm for AF50 - AF75

75mm for AF50 - AF110

Location of side mounted accessories: on right or left hand side. Factory mounted on left hand side for CAL5 on AF50 - AF1650

Holes for screw mounting (screws not supplied). Distance between holes according to EN 50003.

Terminals delivered in open position with captive screws (screws of unused terminals must be tightened).

Screwdriver guidance for all terminals makes it possible to use motorized screwdrivers.

All terminals provide protection against accidental direct contact with live parts according to VDE0106 - Part. 100.

All AF50- AF110 contactor terminals as well as AF50 - AF1650 contactor auxiliary contact and coil terminals ensure IP20 degree of protection according to IEC 947-1.

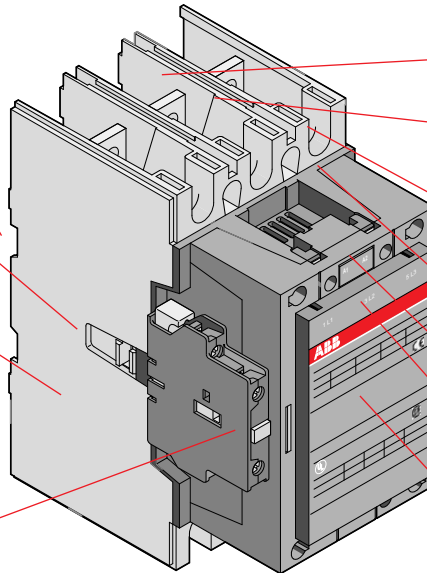

AF50 - AF1650

Surge suppressors built in as standard on the printed circuit board.

Clear marking of coil voltages and frequencies.

Connecting point for control leads in top part of main terminals of AF50 - AF75 contactors. For AF95 & AF110 contactors these are additional power connections.

Terminal marking according to IEC 947-4-1, EN 50005, EN 50012 and NEMA standards.

Location of function marker.

Stops for attaching front mounted accessories.

Terminal screws:

- Posidrive (+,-) No 2 for all AF50 - AF75
- M8 hex threaded socket screw for AF95 - AF1650 main terminals.

Catalog number explanation

AF50 - 30 - 11 - 70

Frame size

Power pole

- 30 = 3 NO
- 40 = 4 NO
- 22 = 2 NO & 2 NC

Coil voltage

(see coil voltage selection chart)

Auxiliary contacts

- 11 = 1 NO & 1 NC
- 00 = No auxiliary provided
- 22 = 2 NO & 2 NC

Coil voltage selection – AF50 to AF1650

AC/DC VOLTS, 40 - 60 Hz

24 - 60 DC	20 - 60 DC	48 - 130 AC/DC	100 - 250 AC/DC	250 - 500 AC/DC
68 ①	72 ②	69	70 ③	71 ④

① AF400 - AF750, DC only.

② AF50 - AF300, DC only.

③ Only option for AF1350 / AF1650.

④ AF400 - AF750 only.

AF50 - AF1650

Non-reversing, mechanically interlocked, reversing
AC & DC operated, UL rated, 3 phase

Across the line
contactors

1



AF63-30-11-70



AF95-30-11-70



AF400-30-11-70



AF750-30-11-70

3 Pole

General purpose current	UL motor switching current	Maximum UL Listed motor horsepower ratings				Standard auxiliary contacts		Non-reversing		Mechanically interlocked		Reversing	
		208V	240V	480V	575/600V	NO	NC	Catalog number	List price	Catalog number	List price	Catalog number	List price
80	54	15	20	40	50	1	1	AF50-30-11-70	\$ 450	AF50M-30-11-70	\$ 953	AF50R-30-11-70	\$ 1,050
90	65	20	25	50	60	1	1	AF63-30-11-70	495	AF63M-30-11-70	1,116	AF63R-30-11-70	1,259
105	80	25	30	60	75	1	1	AF75-30-11-70	535	AF75M-30-11-70	1,399	AF75R-30-11-70	1,542
125	95	30	30	60	75	1	1	AF95-30-11-70	570	AF95M-30-11-70	1,470	AF95R-30-11-70	1,665
140	110	30	40	75	100	1	1	AF110-30-11-70	600	AF110M-30-11-70	1,605	AF110R-30-11-70	1,868
230	130	40	50	100	125	1	1	AF145-30-11-70	1,110	AF145M-30-11-70	2,655	AF145R-30-11-70	2,670
250	156	50	60	125	150	1	1	AF185-30-11-70	1,635	AF185M-30-11-70	3,870	AF185R-30-11-70	3,375
300	192	60	75	150	200	1	1	AF210-30-11-70	1,980	AF210M-30-11-70	4,545	AF210R-30-11-70	4,560
350	248	75	100	200	250	1	1	AF260-30-11-70	2,235	AF260M-30-11-70	5,055	AF260R-30-11-70	5,070
400	302	100	100	250	300	1	1	AF300-30-11-70	2,385	AF300M-30-11-70	6,030	AF300R-30-11-70	6,045
550	414	125	150	350	400	1	1	AF400-30-11-70	3,120	AF400M-30-11-70	6,705	AF400R-30-11-70	6,720
650	480	150	200	400	500	1	1	AF460-30-11-70	4,425	AF460M-30-11-70	13,275	AF460R-30-11-70	13,290
750	602	200	250	500	600	1	1	AF580-30-11-70	6,900	AF580M-30-11-70	18,375	AF580R-30-11-70	18,390
900	810	250	300	600	700	1	1	AF750-30-11-70	7,200	AF750M-30-11-70	19,725	AF750R-30-11-70	19,740
1260	—	—	—	—	—	1	1	AF1250-30-11-70	8,120	—	—	—	—
1350	960	—	400	800	900	1	1	AF1350-30-11-70	8,490	—	—	—	—
1650	1080	—	450	900	1000	1	1	AF1650-30-11-70	10,230	—	—	—	—
2050	—	—	—	—	—	1	1	AF2050-30-11-70	12,820	—	—	—	—

Coil voltage selection – wide range AC/DC coils

All catalog numbers include a 100-250V AC/DC coil. To select other coil voltages, substitute the code from the Coil Voltage Selection Chart for the two digits after the last dash in the catalog number.

Ex.: A 24V coil is required for a AF110 contactor: AF110-30-11-72

Coil voltage selection – AF50 to AF1650

AC/DC VOLTS, 40 - 60 Hz				
24 - 60 DC	20 - 60 DC	48 - 130 AC/DC	100 - 250 AC/DC	250 - 500 AC/DC
68 ①	72 ②	69	70 ③	71 ④

① AF400 – AF1250, DC only.

② AF50 – AF300, DC only.

③ Only option for AF1350 - AF2050.

④ AF400 - AF750 only.

A/AF/AL9 - A/AF/AL110

Contactors for ring tongue termination

AC & DC operated, UL rated, 3 phase

UL general purpose current AC1	UL Motor switching current	UL/CSA horsepower ratings			Auxiliary contacts		AC operated		DC operated	
		240V	480V	575/600V	NO	NC	Catalog number	List price	Catalog number	List price
21	9	2	5	7.5	1 0	0 1	A93010RT-84 A93001RT-84	\$ 83	AL93010RT-81 AL93001RT-81	\$ 152
25	11	3	7.5	10	1 0	0 1	A123010RT-84 A123001RT-84	90	AL123010RT-81 AL123001RT-81	186
30	17	5	10	15	1 0	0 1	A163010RT-84 A163001RT-84	122	AL163010RT-81 AL163001RT-81	207 211
40	28	10	20	25	1 0	0 1	A263010RT-84 A263001RT-84	172	AL263010RT-81 AL263001RT-81	262
80	54	20	40	50	0	0	A503000RT-84	363	AF503000RT-70	582
90	65	25	50	60	0	0	A633000RT-84	417	AF633000RT-70	647
105	80	30	60	75	0	0	A753000RT-84	475	AF753000RT-70	687
125	95	30	60	75	0	0	AF95B3011RT-70	927	AF95B3011RT-70	927
140	110	40	75	100	0	0	AF110B3011RT-70	986	AF110B3011RT-70	986

Coil voltage selection – AC coils

All AC operated catalog numbers include a 120VAC coil. To select other coil voltages, substitute the code from the AC coils Coil Voltage Selection Chart for the two digits after the last dash in the catalog number.

Ex.: A 240V coil is required for an A75 contactor: A753000RT-80

Coil voltage selection – DC coils

All DC operated catalog numbers include a 24VDC coil. To select other coil voltages, substitute the code from the DC coils Coil Voltage Selection Chart for the two digits after the last dash in the catalog number.

Ex.: A 110V coil is required for an AE75 contactor: AE753000RT-86

Auxiliary contact blocks

For additional auxiliary contact blocks, see catalog number explanation on page 1.2. Add \$ 20 to list price for each additional auxiliary, and see page 1.32 for available combinations. Only side-mounted blocks are allowed to be factory installed.

Auxiliary contact block with ring tongue termination

Positioning	Maximum number of contact blocks	Contact description	Catalog number	List price
Front mounting (C4-pole)	1 block A/AE9 – A/AE110	2 NO & 2 NC 3 NO & 1 NC 4 NO	CA5-22ERT CA5-31ERT CA5-40ERT	\$ 35

Coil voltage selection chart – AC coils

Hz	Cntr. type	Volts															
		12	24	48	110	120	125	208	220	240	277	380	415	440	480	500	600
60	A		81	83	84	84		34	36	80	42		86	86	51	53	55
50	A		81	83	84				80			85	86			55	

For other voltages, see page 1.24.

Coil voltage selection chart – DC coils

Hz	Contr. type	Volts					
		24	48	110	125	220	240
DC	AE	81	83	86	87	88	89

For other voltages, see page 1.24.

A9 – AF1650

Non-reversing, mechanically interlocked, reversing
NEMA rated, AC operated, 3 phase

Across the line
contactors



NEMA size	Continuous current	Maximum motor horsepower ratings			Standard Aux. contacts		Non-reversing		Mechanically interlocked		Reversing	
		200V	230V	460/575V	NO	NC	Catalog number	List price	Catalog number	List price	Catalog number	List price
NEMA rated												
00	9	1.5	1.5	2	1	0	A9N00-30-10-84	\$ 78	A9N00M-10-84	\$ 255	A9N00R-10-84	\$ 315
0	18	3	3	5	1	0	A16N0-30-10-84	102	A16N0M-10-84	345	A16N0R-10-84	413
1	27	7.5	7.5	10	1	0	A26N1-30-10-84	183	A26N1M-10-84	405	A26N1R-10-84	480
2	45	10	15	25	1	1	A50N2-30-11-84	330	A50N2M-11-84	713	A50N2R-11-84	810
3	90	25	30	50	1	1	A75N3-30-11-84	413	A75N3M-11-84	1,155	A75N3R-11-84	1,298
4	135	40	50	100	1	1	A145N4-30-11-84	825	A145N4M-11-84	2,235	A145N4R-11-84	2,250
5	270	75	100	200	1	1	A260N5-30-11-84	1,815	A260N5M-11-84	4,485	A260N5R-11-84	4,500
6	540	150	200	400	1	1	AF460N6-3011-70	4,425	AF460N6M-11-70	13,275	AF460N6R-11-70	13,290
7	810	—	300	600	1	1	AF750N7-3011-70	7,200	AF750N7M-11-70	19,725	AF750N7R-11-70	19,740
8	1215	—	450	900	1	1	AF1650N83011-70	10,230	—	—	—	—

Coil voltage selection – A contactors

All AC operated catalog numbers include a 120VAC coil. To select other coil voltages, substitute the code from the Coil Voltage Selection Chart for the two digits after the last dash in the catalog number.

Ex.: A 240V coil is required for an A75 contactor: A75N3-30-11-80

Coil voltage selection – wide range AC/DC coils

The NEMA size 6,7 and 8 contactors are provided with a wide range coil voltage. They are shown with the standard 100-250V AC/DC coil. To select other ranges substitute the code from the coil voltage selection chart for the two digits after the last dash in the catalog number.

Ex.: A 24V coil is required for the AF460N6 contactor: AF460N6-3011-68

Auxiliary contact blocks

For additional auxiliary contact blocks, see catalog number explanation on page 1.2. Add \$ 20 to list price for each additional auxiliary, and see page 1.32 for available combinations.

Mechanical interlock

Mechanically interlocked contactors are designed for reversing, 2 speed, reduced voltage, etc. type starter applications. The complete assembly consists of two mechanically and electrically interlocked contactors mounted as follows with line and load terminals:

- A9 - A16 — mounted on 35mm DIN rail
- A26 - A750 — mounted on common baseplate

Power wiring is not included.

For A9 - A110 contactors the NC electrical interlock is provided with the mechanical interlock.

Reversing

Reversing contactors are designed for reversing type starter applications. The complete assembly consists of two mechanically and electrically interlocked contactors mounted as follows with line and load terminals:

- A9 - A16 — mounted on 35mm DIN rail
- A26 - A750 — mounted on common baseplate

For A9 - A750 contactors the NC electrical interlock is provided with the mechanical interlock.

Coil voltage selection – A contactors

Hz	Cntr type	Volts															
		12	24	48	110	120	125	208	220	240	277	380	415	440	480	500	600
60	A		81	83	84	84		34	36	80	42		86	86	51	53	55
50	A		81	83	84				80				85	86			55

For other voltages, see page 1.24.

Coil voltage selection – AF460N6 to AF1650N8

AC/DC VOLTS, 40 - 60 HZ			
24 - 60 DC	48 - 130 AC/DC	100 - 250 AC/DC	250-500 AC/DC
68 ①	69	70 ③	71 ②

① AF400 – AF750, DC only.

② AF400 - AF750 only.

③ Only option for AF1650.

AE9 – AF1650, AL9 – AL26

Non-reversing, mechanically interlocked, reversing NEMA rated, DC operated, 3 phase



AE26N1-30-11-81



AF145N4-30-11-68



AF460N6R-11-68

AE & AF Contactors

NEMA size	Continuous current	Maximum motor horsepower ratings			Standard Aux. contacts		Non-reversing		Mechanically interlocked		Reversing	
		200V	230V	460/575V	NO	NC	Catalog number	List price	Catalog number	List price	Catalog number	List price
NEMA rated												
00	9	1.5	1.5	2	1	0	AE9N00-30-11-81	\$ 118	AE9N00M-11-81	\$ 325	AE9N00R-11-81	\$ 395
0	18	3	3	5	1	0	AE16N0-30-11-81	142	AE16N0M-11-81	425	AE16N0R-11-81	493
1	27	7.5	7.5	10	1	0	AE26N1-30-11-81	223	AE26N1M-11-81	485	AE26N1R-11-81	560
2	45	10	15	25	1	1	AE50N2-30-11-81	375	AE50N2M-11-81	803	AE50N2R-11-81	930
3	90	25	30	50	1	1	AE75N3-30-11-81	518	AE75N3M-11-81	1,365	AE75N3R-11-81	1,493
4	135	40	50	100	1	1	AF145N4-3011-70	1,110	AF145N4M-11-70	2,655	AF145N4R-11-70	2,670
5	270	75	100	200	1	1	AF260N5-3011-70	2,235	AF260N5M-11-70	5,055	AF260N5R-11-70	5,070
6	540	150	200	400	1	1	AF460N6-3011-70	4,425	AF460N6M-11-70	13,275	AF460N6R-11-70	13,290
7	810	—	300	600	1	1	AF750N7-3011-70	7,200	AF750N7M-11-70	19,725	AF750N7R-11-70	19,740
8	1215	—	450	900	1	1	AF1650N83011-70	10,230	—	—	—	—

AL Contactors

NEMA size	Continuous current	Maximum motor horsepower ratings			Standard Aux. contacts		Non-reversing		Mechanically interlocked		Reversing	
		208V	240V	460/575V	NO	NC	Catalog number	List price	Catalog number	List price	Catalog number	List price
NEMA rated												
00	9	1.5	1.5	2	1	0	AL9N00-30-10-81	\$ 155	AL9N00M-10-81	\$ 319	AL9N00R-10-81	\$ 379
0	18	3	3	5	1	0	AL16N0-30-10-81	205	AL16N0M-10-81	441	AL16N0R-10-81	501
1	27	7.5	7.5	10	1	0	AL26N1-30-10-81	253	AL26N1M-10-81	473	AL26N1R-10-81	533

Coil voltage selection – AE contactors

All DC operated catalog numbers include a 24VDC coil. To select other coil voltages, substitute the code from the Coil Voltage Selection Chart for the two digits after the last dash in the catalog number.

Ex.: A 125V coil is required for an AE75 contactor: AE75N3-30-11-87

Coil voltage selection – AF wide range AC/DC coils

All catalog numbers include a 100-250V AC/DC coil. To select other coil voltages, substitute the code from the Coil Voltage Selection Chart for the two digits after the last dash in the catalog number.

Ex.: A 24V coil is required for a AF145 contactor: AF145N4-30-11-72

Auxiliary contact blocks

For additional auxiliary contact blocks, see catalog number explanation on page 1.2. Add \$ 20 to list price for each additional auxiliary, and see page 1.32 for available combinations.

Mechanical interlock

Mechanically interlocked contactors are designed for reversing, 2 speed, reduced voltage, etc. type starter applications. The complete assembly consists of two mechanically and electrically interlocked contactors mounted as follows with line and load terminals:

- AE9 - AE16 — mounted on 35mm DIN rail
- AE26 - AE75 — mounted on common baseplate

Power wiring is not included.

For AE9 - AE75 contactors the NC electrical interlock is provided with the mechanical interlock.

Reversing

Reversing contactors are designed for reversing type starter applications. The complete assembly consists of two mechanically and electrically interlocked contactors mounted as follows with line and load terminals:

- AE9 - AE16 — mounted on 35mm DIN rail
- AE26 - AE75 — mounted on common baseplate

For AE9 - AE75 contactors the NC electrical interlock is provided with the mechanical interlock.

Coil voltage selection – AF50 to AF1650

AC/DC VOLTS, 40 - 60 Hz				
24 - 60 DC	20 - 60 DC	48 - 130 AC/DC	100 - 250 AC/DC	250 - 500 AC/DC
68 ①	72 ②	69	70 ③	71 ③

Coil voltage selection – AE & AL contactors

Hz	Contactor type	Volts						
		12	24	48	110	125	220	240
DC	AE, AL	—	81	83	86	87	88	89

① AF400 – AF750, DC only.
② AF50 – AF300, DC only.

③ AF400 - AF750 only.
④ Only option for AF1650.

A9 – A/AE75 , EK110 – EK1000, AL9 – AL26 AC & DC operated, UL rated, 4 pole

Across the line
contactors

1

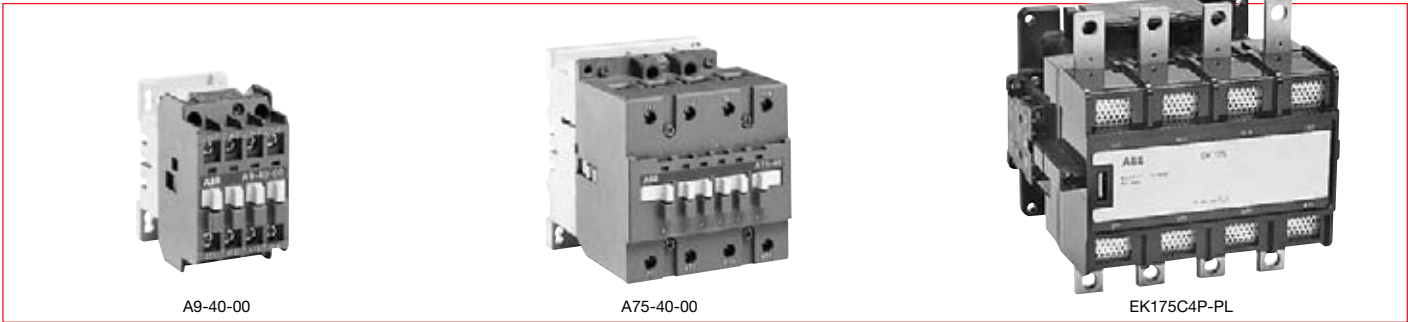

4 Pole – 4 NO power poles

UL general purpose current		AC operated		DC operated	
AC operated	DC operated	Catalog number	List price	Catalog number	List price
21	21	A9-40-00-84	\$ 120	AL9-40-00-81	\$ 141
30	30	A16-40-00-84	165	AL16-40-00-81	192
40	40	A26-40-00-84	228	AL26-40-00-81	246
65	65	A45-40-00-84	360	AE45-40-00-86	420
80	80	A50-40-00-84	413	AE50-40-00-86	473
105	105	A75-40-00-84	525	AE75-40-00-86	570
150	150	EK110C4P-1L	743	EK110C4P-PL	953
200	200	EK150C4P-1L	1,013	EK150C4P-PL	1,238
250	250	EK175C4P-1L	1,763	EK175C4P-PL	1,988
300	300	EK210C4P-1L	2,025	EK210C4P-PL	2,280
400	400	EK370C4P-1L	4,650	EK370C4P-PL	5,010
600	600	EK550C4P-1L	6,510	EK550C4P-PL	7,005
1000 ①	1000 ①	EK1000C4P-1L	9,000	EK1000C4P-PL	9,700

4 Pole – 4 NC power poles

UL general purpose current	AC operated
AC operated	Catalog number
30	A16-04-00-84

4 Pole – 2 NO & 2 NC power poles

UL general purpose current		AC operated		DC operated	
AC operated	DC operated	Catalog number	List price	Catalog number	List price
21	21	A9-22-00-84	\$ 120	AL9-22-00-81	\$ 141
30	21	A16-22-00-84	165	AL16-22-00-81	215
40	30	A26-22-00-84	228	AL26-22-00-81	278
65	65	A45-22-00-84	360	AE45-22-00-86	420
105	105	A75-22-00-84	525	AE75-22-00-86	570

Coil voltage selection

All AC operated catalog numbers include a 120VAC coil. All DC operated catalog numbers include a 110VDC coil. To select other coil voltages, substitute the code from the Coil Voltage Selection Chart for the two digits after the last dash in the catalog number.

Ex.: A 240V coil is required for an A75 contactor: A75-30-00-80

Auxiliary contact blocks

For additional auxiliary contact blocks, see catalog number explanation on page 1.2. Add \$ 20 to list price for each additional auxiliary, and see page 1.32 for available combinations.

Accessories for EK

Please consult factory.

Coil voltage selection – A contactors

Hz	Contr.	Volts															
		12	24	48	110	120	125	208	220	240	277	380	415	440	480	500	600
60	A		81	83	84	84		34	36	80	42		86	86	51	53	55
50	A		81	83	84				80				85	86			55

For other voltages, see page 1.24.

Coil voltage selection – EK contactors

Hz	Contr.	Volts														
		24	48	110	120	125	208	220	240	277	380	415	440	480	500	600
60	EK	F	G		1		B		2	C	Z		3	4		6
50	EK	N		1				J			3	M			5	
DC	EK	Y	W	P		Q		R					T			

- For other voltages, consult factory.
- 24 & 48VAC coils are not available for sizes EK550. For these applications, use an interposing control relay.

Coil voltage selection – AE & AL contactors

Hz	Contr.	Volts						
		12	24	48	110	125	220	240
DC	AE, AL	-	81	83	86	87	88	89

For other voltages, see page 1.24.

① Not UL Listed. IEC value AC1 for 40°C.

AF45 - AF75

AC & DC operated, UL rated, 4 pole

Auxiliary contact blocks

For additional auxiliary contact blocks, see catalog number explanation on page 1.8. Add \$ 20 to the list price for each additional auxiliary and see page 1.32 for available combinations. If auxiliary contacts are required for AF50 – AF750 contactors, add \$ 40 to the list price and change the 8th & 9th digits in the catalog number from "00" to "11".

4 Pole – 4 NO power poles

General purpose	Auxiliary contacts		Catalog number	List price
	NO	NC		
AC1				
65	0	0	AF45-40-00-70	\$ 385
80	0	0	AF50-40-00-70	435
105	0	0	AF75-40-00-70	645

4 Pole – 2 NO - 2 NC power poles

General purpose	Auxiliary contacts		Catalog number	List price
	NO	NC		
AC1				
65	0	0	AF45-22-00-70	\$ 385
105	0	0	AF75-22-00-70	645

These contactors (2 NO & 2 NC power poles) can be used for controlling either 2 separate circuits, i.e. 2 loads with 2 separate supplies, or 1 circuit comprising 2 separate loads with 1 single supply (see diagrams below).

When the contactor operates, there is no mechanical overlapping between the NO main poles and NC main poles: Break before Make.

These contactors (2 NO & 2 NC power poles) are not suitable for a reversing starter or a wye-delta starter or for controlling a single load from 2 separate supplies.

1 single supply and 2 separate loads

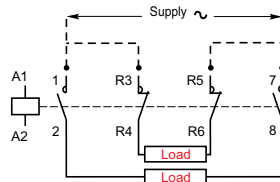

2 separate supplies and 2 separate loads

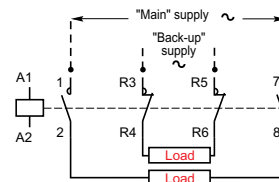

Coil voltage selection – wide range AC/DC coils

All catalog numbers include a 100-250V AC/DC coil. To select other coil voltages, substitute the code from the Coil Voltage Selection Chart for the two digits after the last dash in the catalog number.

Ex.: A 24V coil is required for a AF45 contactor: AF45-22-00-72

Coil voltage selection – AF50 to AF75

AC/DC VOLTS, 40 - 60 HZ			
24 - 60 DC	20 - 60 DC	48 - 130 AC/DC	100 - 250 AC/DC
68 ①	72 ②	69	70

① AF400 – AF750, DC only.
 ② AF50 – AF300, DC only.

UA26 – UA110

for 3 phase capacitor switching, 3 phase
AC operated

Across the line
contactors

1



UA75-30-00-84



UA95-30-00-84

Max kvar switching capacity			Standard auxiliary contacts		Catalog number	List price
240V	480V	575/600V	NO	NC		
12.5	25	30	1	0	UA26-30-10-84	\$ 225
16	32	40	1	0	UA30-30-10-84	338
20	40	50	0	0	UA50-30-00-84	345
			1	1	UA50-30-11-84	375
27.5	55	70	0	0	UA75-30-00-84	450
			1	1	UA75-30-11-84	480
35	70	75	0	0	UA95-30-00-84	465
			1	1	UA95-30-11-84	495
40	80	85	0	0	UA110-30-00-84	525
			1	1	UA110-30-11-84	570

For 3 phase capacitors carrying out single bank or stepped bank compensation.
Max. peak current \hat{I} : 100 times the capacitor nominal r.m.s. current at $U_e \leq 500V$ or 90 times for $U_e > 500V$
Electrical durability: 100,000 operating cycles.

Power in kvar

Contactor	208V	240V	480V	600V	Max amps
UA26	3.5	4.0	8.0	10.0	10
UA30	7.0	8.0	16.5	20.5	20
UA50	10.5	12.5	25.0	31.0	30
UA75	21.5	25.0	50.0	62.0	60
UA95	25.0	29.0	58.0	72.0	70
UA110	28.5	33.0	66.0	83.0	80
A145	43	50	100	125	120
A185	57	66	133	166	160
A210	66	77	153	192	185
A260	75	87	174	218	210
A300	88	101	203	254	245
AF400	119	137	274	343	330
AF460	142	164	329	410	396
AF580	178	205	411	514	495
AF750	214	247	495	618	595

Coil voltage selection

All AC operated catalog numbers include a 120VAC coil. To select other coil voltages, substitute the code from the Coil Voltage Selection Chart for the two digits after the last dash in the catalog number.

Auxiliary contact blocks

For additional auxiliary contact blocks, see catalog number explanation on page 1.2. Add \$20 to list price for each additional auxiliary, and see page 1.32 for available combinations.

Coil voltage selection chart

Hz	Cntr type	Volts															
		12	24	48	110	120	125	208	220	240	277	380	415	440	480	500	600
60	A		81	83	84	84		34	36	80	42		86	86	51	53	55
50	A		81	83	84				80			85	86			55	

For other voltages, see page 1.24.

Accessories for A/AF/AL & AE contactors



CAL5-11



CA5-10

Auxiliary contact blocks – Standard

Positioning	Maximum number of contact blocks	Contact Description	Catalog number	List price
Front mounting (single pole)	4 blocks: A9 – A26 AE9 – AE26 AL9 – AL26	1 N.O. 1 N.C.	CA5-10 CA5-01	\$ 15
	5 blocks: A30, A40, AE30, AE40, AL30, AL40 6 blocks: A45 – A110 AE45 – AE110 AF45 – AF110		1 N.O. Early make 1 N.C. Late break	
Front mounting (4 pole)	1 block: A9 – A26-40-00 A30 – A110 AE9 – AE110	4 N.O. 3 N.O. & 1 N.C. 2 N.O. & 2 N.C. 4 N.C. 2 N.O./2 N.C.Ⓣ	CA5-40E CA5-31E CA5-22E CA5-04E CA5-11/11E	30
	1 block: A9 – A40-30-10 AL9 – AL40-30-10		3 N.O. & 1 N.C. 2 N.O. & 2 N.C. 1 N.O. & 3 N.C. 4 N.C. 4 N.O. 2 N.O./2 N.C.Ⓣ	
Side mounting (2 pole)	2 blocks: A9 – A75, AE9-AE45 1 block: AE50 – AE75, AL9 – AL40	1 N.O. & 1 N.C.	CAL5-11	
	1 block: A/AE/AF95 – A/AE/AF110		CAL18-11	
	2 blocks: A145 – A300, AF145-AF2050 2 blocks: A145 – A300, AF145-AF2050		1 N.O. & 1 N.C. (inside L or R) 1 N.O. & 1 N.C. (outside, L or R)	

Auxiliary contact blocks – Front mounting, switching low voltage and low current

Positioning	Maximum number of contact blocks	Contact Description	Degree of protection	Catalog number	List price
Front mounting (single pole)	4 blocks: A9 – A26 AE9 – AE26 AL9 – AL26	1 N.O. 1 N.C.	IP40 IP40	CE5-10D0.1 CE5-01D0.1	\$ 38
				1 N.O. 1 N.C.	
Front mounting (single pole)	5 blocks: A30, A40, AE30, AE40, AL30, AL40 6 blocks: A45 – A110 AE45 – AE110 AF45 – AF110	1 N.O. 1 N.C. 1 N.O. 1 N.C.	IP67 IP67 IP67 IP67	CE5-10W0.1 CE5-01W0.1	42
				CE5-10W2 CE5-01W2	

Ⓣ Includes 1 N.O. & 1 N.C. overlapping

Accessories

Auxiliary contact block technical data

CA5/CAL5-11/CAL18-11/CC5

Across the line
contactors

1

Types	1-pole CA5, 4-pole CA5 2-pole CAL5-11 and 1-pole CC5		CAL18-11 CAL18-11B
Standards	IEC 947-5-1 and EN 60947-5-1		
Rated insulation voltage U_i according to IEC 947-5-1	V	690	690
according to UL/CSA	V	600	690
Rated operational voltage U_e	~ V	24 to 690	
Conventional thermal current I_{th}	A	16	
Rated operational current I_e in AC-15 acc. to IEC 947-5-1	24 to 127 V 220 to 240 V 380 to 440 V 500 to 690 V	A A A A	6 4 3 2
in DC-13 acc. to IEC 947-5-1	24 V 48 V 72 V 125 V 250 V	A A A A A	6 2.8 1 0.55 0.3
Connecting terminals (delivered in open position. Screws of unused terminals should be tightened).	M 3.5 (+,-) pozidriv 2 screw with cable clamp		
Connecting capacity	1 or 2 x mm ²		
• Rigid solid	1 to 4		
• Flexible with cable end	1 x mm ² 2 x mm ²	0.75 to 2.5 0.75 to 2.5	
Mechanical durability	cycles	10 million, A9 - A75;	5 million, A/AF95 - A/AF185; 3 million, A/AF210 - AF750; 0.5 million, AF1350 & AF1650
Max. switching frequency	cycles/h	3600	
Electrical durability	See curve below		
Max. switching frequency	cycles/h	1200	
Rated making capacity	10 x I_e AC-15		
Rated breaking capacity	10 x I_e AC-15		
Rated short-time withstand current I_{cw} q = 40°C	1 s 0.1 s	A A	100 140
Min. switching capacity	17 V / 1 mA		24V / 50 mA
Short-circuit protection - gG (gl) fuses	A	10	
Power loss per pole at 6 A	W	0.15	
Degree of protection according to IEC 529, IEC 144, DIN 40 050 and NFC 20-010	IP 20		

CAL18

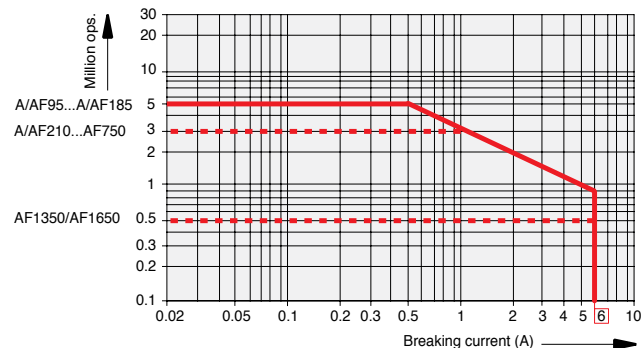

Electrical durability

AC-15 according to IEC 947-5-1

making current: $10 \times I_e$ where $\cos \phi = 0.7$ and U_e

breaking current: I_e where $\cos \phi = 0.4$ and U_e

The curves opposite show the electrical durability of the auxiliary contact blocks according to breaking current I_c .

These curves have been plotted for resistive and inductive loads up to 690 V, 40 to 60 Hz.

CA5, CAL5

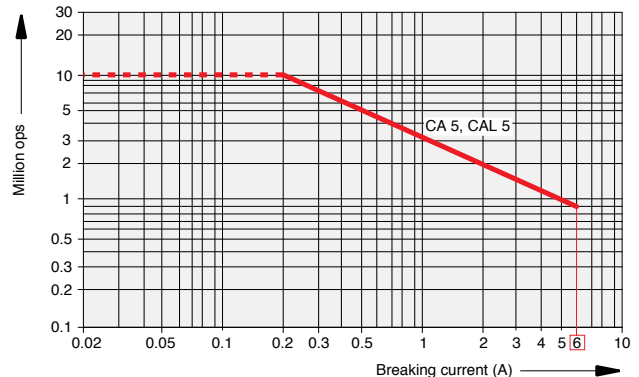

Accessories

Auxiliary contact block technical data

CE5

Auxiliary contact blocks for switching low level voltage and current

Types		CE5-10D0.1 CE5-01D0.1 CE5-10W0.1 CE5-01W0.1 Version 100 mA	CE5-10DZ CE5-01DZ CE5-10WZ CE5-01WZ Version 2 A
Standards		IEC 947-5-1 and EN 60947-5-1	
Approvals		UL / CSA	
Rated insulation voltage U_i according to IEC 947-5-1	V	250	250
according to UL/CSA	V	125	250
Rated operational voltage U_e	V	125	250
Rated operational current I_e in AC-15 or AC-14 acc. to IEC 947-5-1	A	0.1	2
in DC-12 acc. to IEC 947-5-1	A	0.1	2
24 V	A	0.1	0.5
60 V	A	0.1	0.2
110 V	A	0.1	0.1
220 V	A	0.1	
Minimal switching		3 V / 1 mA	17 V / 1 mA
Reliability for the minimal switching		10 ⁻⁸	
Connecting terminals		M3.5 (+,-) posidriv 2 screw with cable clamp	
Connecting capacity • Rigid solid • Flexible with cable end		1 ou 2 (1...4) mm ² 1 ou 2 (0.75... 2.5) mm ²	
Short circuit protection		100 mA	10 A
Degree of protection according to IEC529, IEC 144, DIN 40 050, NFC 20-010	IP 20		
Mounting		Front mounting on contactors: A, AE, TAE9...110, AL, AF, GA, N, NE	
Dimensions		Identical to those of CA5 single pole	

Accessories for A/AF/AL & AE contactors

Across the line
contactors

1



TP40DA



VE5-1



VM300H



LK75-L

LK75-F

LK110

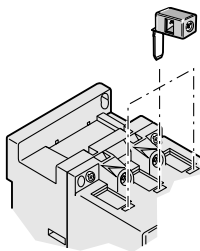

Pneumatic timers

Mounting on	Timing range	Contacts		Catalog number	List price
		N.O.	N.C.		
A9 – A75	On delay 0.1 – 40 s	1	1	TP40DA	\$ 108
AE9 – AE75	On delay 10 – 180 s	1	1	TP180DA	
AL9 – AL40	Off delay 0.1 – 40 s	1	1	TP40IA	
	Off delay 10 – 180 s	1	1	TP180IA	

Interlocks for two horizontally mounted contactors – A9 - A110

Feature	Mounting on	Contacts		Catalog number	List price
		N.O.	N.C.		
Mechanical/electrical	A/AE/AL9 – A/AE/AL40	–	2	VE5-1	\$ 45
Mechanical/electrical	A45 – A110	–	2	VE5-2 ^①	45
Mechanical	A/AE/AL9 – A/AE/AL40	–	–	VM5-1	21

Interlocks for two horizontally mounted contactors – A95 - AF1250 contactors

Feature	Left contactors	Right contactors	Catalog number	List price
Mechanical	A210 – A300	AF400 – AF460	VM300/460H	130
Mechanical	AF400 – AF1250	AF400 – AF1250	VM750H	150

Interlocks for two vertically mounted contactors – A95 - AF1250 contactors

Feature	Top contactor	Bottom Contactor	Catalog number	List price
Mechanical	A210 – A300	AF400 – AF460	VM300/460V	250
Mechanical	AF400 – AF1250	AF400 – AF1250	VM750V	270

Interlocks for two horizontally mounted contactors – AF1350 - AF2050 contactors

Feature	Left contactor	Right Contactor	Catalog number	List price

Auxiliary lead terminals

Connections	Mounting on	Catalog number	List price
Connects from top	A50 – A75	LK75-F	15
Connects from side	A95 – A110	LK110	23

^① Use type VE 5-2 for mechanical and electrical interlocking between A30/A40 and A50 - A75 contactors.

Accessories for A/AE/AL/AF contactors



Terminal lug kits (Set of 3)

Wire range	For contactor	Catalog number	List price
6 – 300 MCM	A145 – A185	ATK185	\$ 45
4 – 400 MCM	A210 – A300	ATK300	68
(2) 4-500 MCM	A210 – A300	ATK300/2	110
(2) 2/0 – 500 MCM	AF400 – AF580	ATK580/2	150
(3) 2/0 – 500 MCM	AF580 – AF1250	ATK750/3	225
(4) 4/0 – 500 MCM	AF1350	ATK1350/4	235
(4) 1/0 – 750 MCM	AF1350 – AF2050	ATK1650/4	335
(6) 1/0 – 750 MCM	AF1350 – AF2050	ATK1650/6	560

Contact kits

For contactors	Catalog number	List price
3 Pole		
A/AE/AF50	ZL50	\$ 113
A/AE/AF63	ZL63	135
A/AE/AF75	ZL75	158
A/AE/AF95	ZL95	225
A/AE/AF110	ZL110	255
A/AF145	ZL145	300
A/AF185	ZL185	420
A/AF210	ZL210	525
A/AF260	ZL260	855
A/AF300	ZL300	1,020
AF400	ZL400	1,716
AF460	ZL460	2,434
AF580	ZL580	3,795
AF750	ZL750	3,960
AF1250	ZL1250	5,280
AF1350	ZL1350	4,255
AF1650	ZL1650	4,890
AF2050	ZL2050	6,290
4 Pole		
A/AE45	ZLT45	150
A/AE50	ZLT50	150
A/AE75	ZLT75	210
3 Pole		
UA50	ZLU50	150
UA75	ZLU75	215
UA95	ZLU95	306
UA110	ZLU110	347

Mechanical latches

For contactors	Catalog number	List price
A9 - A75, AE45 - AE75, & AL9 - AL40	WB75A-Δ	\$ 84

Δ - Coil voltage suffix. Refer to Coil Voltage Selection chart and substitute the desired coil voltage suffix for the Δ.

Coil voltage selection chart – mechanical latches for A, AE & AL contactors

50 Hz (AC/DC)	60 Hz (AC)	Voltage code	50 Hz (DC)	60 Hz (AC)	Voltage code
24	24 – 28	01	220 – 230	220 – 255	06
42	42 – 48	02	230 – 240	230 – 277	05
48	48 – 55	03	380 – 415	380 – 440	07
110	110 – 127	04	415 – 440	440 – 480	08

Range: WB75A for contactors A9 – A75, AL9 – AL40, AE45 – AE75 and control relays N and NL.

Description: WB75A block: contains a mechanical latching device with electromagnetic impulse unlatching (AC or DC) or manual unlatching. Captive screw type connecting terminals, built-in cable clamps, M 3.5 (=, -) posidrive 1 screw with screwdriver guidance, delivered untightened and protected against accidental direct contact.

Operation: After closing, the contactor continues to be held in the closed position by the latching mechanism should the supply voltage fail at the contact coil terminals.

Contactor opening can be controlled:

- Electrically by an impulse* (AC or DC) on the WB75A block coil. The coil is not designed to permanently energized.
- Manually by pressing the pushbutton on the front face of the WB75A block.

Mounting: WB75A is clipped onto the front face of the contactor.

Identification markers

Mounting on	Coil voltage	Catalog number	List price
A/AE/AL/AF9 – A/AE/AL/AF110	Pack of 50	BA5-50	\$ 15

Accessories for A/AE/AL/AF contactors

Across the line
contactors

1

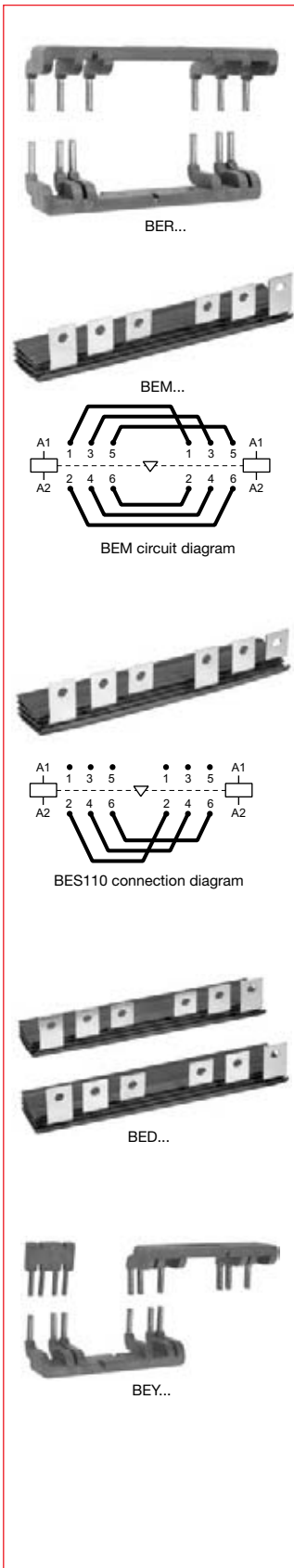

Connection kits for reversing

Mounting on 3 pole contactors	Catalog number	List price
A/AE/AL9 – A/AE/AL16 A/AE/AL26 – A/AE/AL40	BER16V BER40V	\$ 35 49
A/AE/AF50 – A/AE/AF75 A/AE/AF95, A/AE/AF110 A/AF145 – A/AF185 A/AF210 – A/AF300	BEM75-30 BEM110-30 BEM185-30 BEMA300-30	165 180 260 470
AF400 – AF460 AF580 – AF750	BEM460-30 BEM750-30	850 1,200

Application

Connections between the main poles of **two 3 pole contactors** mounted side by side so that they operate as reversing contactors.

Description

The connection kits for reversing contactors are made up of three reversing connections and three phase to phase connections.

- BER16V – Molded plastic, solid copper bars
- BER40V – Molded plastic, solid copper bars
- BEM75 and 110-30 – Insulated, solid copper bars

Connection kits for phase to phase

Mounting on 3 pole contactors	Catalog number	List price
A/AE/AF50, A/AE/AF75 A/AE/AF95, A/AE/AF110 A/AF145 – A/AF185 A/AF210 – A/AF300	BES75-30 BES110-30 BES185-30 BESA300-30	\$ 75 90 130 200
AF400 – AF460 AF580 – AF750	BES460-30 BES750-30	425 650

The connection kit for phase to phase contactors is made up of three phase to phase bus bars.

Connection kits for wye-delta starters

Mounting on contactors		Catalog number	List price
Line and delta contactor	Wye contactor		
A9	A9	BEY16V-2	\$ 46
A12	A9		
A16	A12		
A26	A16	BEY26-2	76
A30	A26	BEY40-2	76
A40	A26		
A50	A30	BED50U	165
A63	A40		
A75	A50		
A95	A75	BED75U	180
A110	A95	BED95U	195
A145	A110	BED110U	225
A185	A145	BED145U	250
A210	A185	BED185U	290
A260/A300	A210	BED210U	375
AF400/AF460	A260/A300	BED300U	500
AF460	AF400	BED400U	850
AF580	AF400/AF460	BED460U	900
AF750	AF580	BED580U	1,250
		BED750U	1,450

Application

Connections between the main poles of a wye-delta starter.

Description

- Three line contactor/wye contactor connections – line side.
- Three wye contactor/delta contactor connections – load side.
- The shorting connection for the “S” contactor.

BEY16V-2, BEY26-2, BEY40-2 – Molded plastic, solid copper bars

BED50U thru BED750U – Insulated, solid copper bars.

The above connection sets allow a mechanical interlock unit to be mounted between the wye and delta contactors if required.

Accessories for A/AE/AL/AF contactors

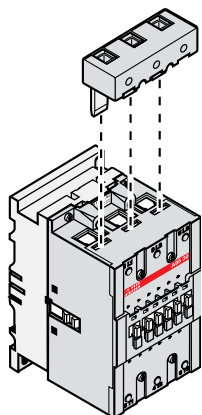

LD110



BEXT-75



LX...



LT185-AC



LT185-AL

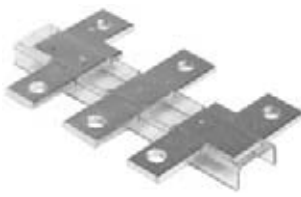

LW...

Additional terminal blocks

Mounting on 3 pole contactors	Wire range	Catalog number	List price
A/AE/AL9 – A/AE/AL16 (set of 2)	16 – 6	LD-16	\$ 20
A/AE/AL26 (set of 2)	14 – 6	LD-26	22
A/AE/AL30 – A/AE/AL40	12 – 4	LD-40	26
A/AE/AF50 – A/AE/AF75	10 – 2	LD-75	28
A/AE/AF95 – A/AE/AF110	8 – 1	LD-110	30

Utilization – The LD series terminal block is designed to increase the connection capacity of the contactor on which it is mounted. The LD 75 and LD110 terminal blocks are mounted in the three independent apertures located above the built-in connectors.

Terminal extensions

Mounting on contactors	Catalog number	List price
A/AE/AF50 – A/AE/AF75	BEXT-75	\$ 15
A/AE/AF95, A/AE/AF110	LW110	95
A/AF145 – A/AF185	LX185	90
A/AF210 – A/AF300	LX300	140
AF400 – AF460	LX460	195
AF580 – AF750	LX750	225

Application

They are designed to increase the width of the contactor terminal pads to allow larger connectors to be mounted.

Description

Terminal extension sets contain 3 bars.

Terminal shrouds – two pieces

For contactor	Catalog number	List price
A/AF145 – A/AF185 for flush mount A/AF145 – A/AF185 for extended mount A/AF145 – A/AF185 for shorting bar LY... between A(F)145 / A(F)185 & TA200DU A/AF210 – A/AF300 for flush mount A/AF210 – A/AF300 for extended mount A/AF210 – A/AF300 for shorting bar LY300	LT185-AC LT185-AL LT185-AY LT300-AC LT300-AL LT300-AY	\$ 10
AF400 – AF460 for flush mount AF400 – AF460 for extended mount AF580 – AF1250 for flush mount AF580 – AF1250 for extended mount	LT460-AC LT460-AL LT750-AC LT750-AL	20

Terminal enlargements

For contactor	Catalog number	List price
A/AF95 – A/AF110	LW110	\$ 95
A/AF145 – A/AF185	LW185	120
A/AF210 – A/AF300	LW300	130
AF400 – AF460	LW460	295
AF580 – AF750	LW750	355
AF1250	LW1250	375

Arc chutes

For contactor	Catalog number	List price
A/AF145 – A/AF185	ZW185	\$ 130
A/AF210 – A/AF300	ZW300	180
A/AF400 – A/AF460	ZW460	190
A/AF580 – A/AF750	ZW750	230
AF1350 – AF1650	ZW1650	215

Accessories for A/AE/AF contactors

Across the line
contactors

1

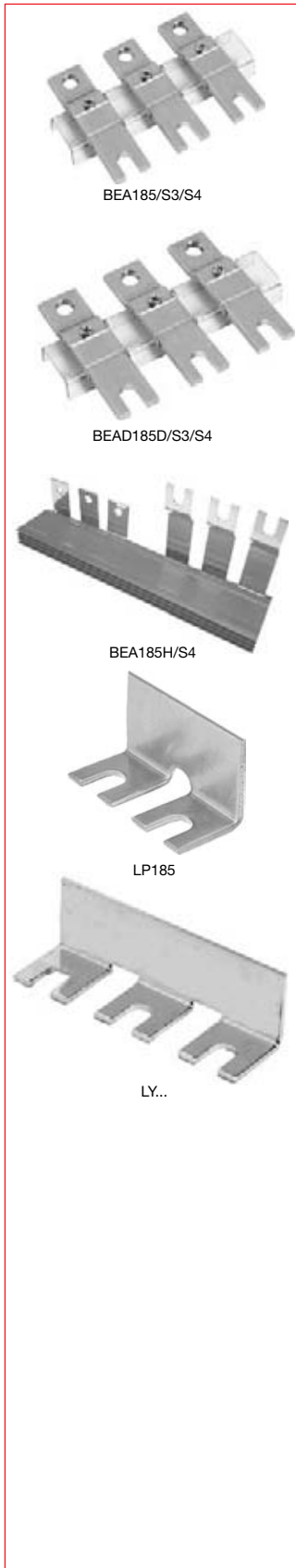

Vertical connection bars between contactor and MCCB – three bars

MCCB	For contactor	Catalog number	List price
T1	A/AE/AF50 – A/AE/AF75	BEA75/T1	\$ 85
T3	A/AE/AF95 – A/AE/AF110	BEA110/T3	95
T3	A/AF145 – A/AF185	BEA185/T3	60
S3, S4	A/AF145 – A/AF185	BEA185/S3/S4	60
T4	A/AF145 – A/AF185	BEA185/T4	70
T4	A/AF210 – A/AF300	BEA210/T4	70
T5	A/AF210 – A/AF300	BEA300/T5	75
T5	A/AF400 – A/AF750	BEA750/T5	115
S5	A/AF210 – A/AF300	BEA300/S5	75
S5 ^①	AF400 – AF460	BEA400/S5	95
S6	AF400 – AF750	BEA750/S6	115

Vertical connection bars between contactor and MCCB – three bars

MCCB	For contactor	Catalog number	List price
S3, S4	A/AF145 – A/AF185	BEA185D/S3/S4	\$ 70
S4	A/AF210 – A/AF300	BEA210D/S4	80
S5	A/AF210 – A/AF300	BEA300D/S5	85
S5	AF400 – AF460	BEA400D/S5	105
S6	AF400 – AF750	BEA750D/S6	125

To be used when power take off is needed (IP00) or with other bus bars. (EX: Reversing, IP20)

Horizontal connection busbars between contactor and MCCB – three bars

MCCB	For contactor	Catalog number	List price
S3, S4	A/AF145 – A/AF185	BEA185H/S4	\$ 150
S4	A/AF210 – A/AF300	BEA210H/S4	220
S5	A/AF210 – A/AF300	BEA300H/S5	220
S5	AF400 – AF460	BEA400H/S5	435
S6	AF400 – AF460	BEA460H/S6	660
S6	AF580 – AF750	BEA750H/S6	670

Shorting bars, 2 pole

For contactor	Catalog number	List price
A/AF145 – A/AF185	LP185	\$ 35
A/AF210 – A/AF300	LP300	50
AF400 – AF460	LP460	50
AF580 – AF750	LP750	50

Shorting bars, 3 pole

For contactor	Catalog number	List price
A/AE45 – A/AE/AF75	LF75	\$ 40
A/AE/AF95 – A/AE/AF110	LY110	40
A/AE/AF145 – A/AE/AF185	LY185	40
A/AE/AF210 – A/AE/AF300	LYA300	60
AF400 – AF460	LY460	60
AF580 – AF750	LY750	60

① Not for use with flange handles.

Accessories for A/AE/AL/AF contactors Coils & coil voltage codes

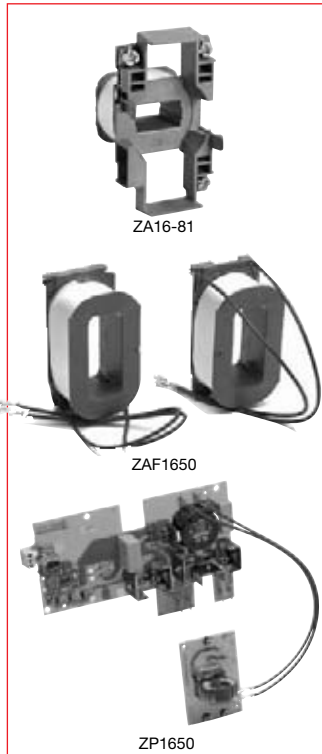

Coils – AC operated

For contactors	Catalog number	List price
A9 – A16	ZA16-Δ	\$ 24
A26 – A40	ZA40-Δ	30
A45 – A75	ZA75-Δ	57
A95 – A110	ZA110-Δ	60
A145 – A185	ZA185-Δ	150
A210 – A300	ZA300-Δ	180

Coils – DC operated

AE9 – AE16	ZAE16-Δ	24
AE26 – AE40	ZAE40-Δ	30
AE45 – AE75	ZAE75-Δ	57
AE95 – AE110	ZAE110-Δ	90
Auxiliary including an insertion contact and a varistor for DC operated contactors AE95 – AE110	CCL18-01	45

Coils – AC/DC operated (coil and printed circuit board except ZAF1650)

AF45 – AF75	ZAF75-Δ	120
AF95, AF110	ZAF110-Δ	165
AF145 – AF185	ZAF185-Δ	200
AF210 – AF300	ZAF300-Δ	240
AF400, AF460	ZAF460-Δ	450
AF580, AF750, AF1250	ZAF750-Δ	525
AF1350, AF2050 (Set of 2 coils only)	ZAF1650-Δ	920

Printed circuit board – AC/DC operated

AF1350 – AF2050	ZP1650	1,620
-----------------	--------	-------

Δ – Coil voltage suffix. Refer to Coil Voltage Selection charts below and substitute the desired coil voltage code for the Δ.

Coil voltage selection – AC operated for A9 – A300; UA26 – UA110

VAC (50Hz)	VAC (60Hz)	Voltage Code
24	24	81
26	28	16
28	32	17
42	42	82
48	48	83
60	60	73
100	100 – 110	74 ②
110	110 – 120	84
110 – 115	115 – 127	89 ③
120	140	29
125 – 127	150	30
175	208	34
190	220	36
200	200 – 220	75 ②
220 – 230	230 – 240	80
230 – 240	240 – 260	88
230 – 240	277	42
230/400	–	62 ①
–	230/400	63 ①
380 – 400	400 – 415	85
400 – 415	415 – 440	86
–	480	51
440	500	53
500	600	55
550	–	56
660 – 690	–	58

Coil voltage selection – DC operated for AE contactors

VDC	Voltage code AE contactors
12	80
24	81
42	82
48	83
50	21
60	84
75	85
110	86
125	87
220	88
240	89
250	38

Coil voltage selection – AC/DC operated for AF50 – AF2050

VAC & VDC 40-60 Hz	Suffix Code
24 – 60 VDC	68 ④
20 – 60 VDC	72 ⑤
48 – 130 VAC/VDC	69
100 – 250 VAC/VDC	70 ⑦
250 – 500 VAC/DC	71 ⑥

① Only for A9 – A16.
② Not for A145 – A300
③ A145 – A300 at 60 Hz, 115V only
④ AF400 – AF1250, DC only
⑤ AF45 – AF300
⑥ AF400 – AF750 only
⑦ Only option for AF2050 – AF1650

Accessories for EK contactors Coils & coil voltage codes

Across the line
contactors

1

Coils – AC & DC operated

Contactor size	AC Coils		DC Coils	
	Catalog number	List price	Catalog number	List price
EK110, EK150	KH210-Δ	\$ 200	KH210-Δ	\$ 200
EK175, EK210	KH300-Δ	240	KH300-Δ	240
EK370, EK550	KH800-Δ	580	KH800-Δ	580

Δ – Coil voltage suffix. Refer to the Coil Voltage Selection chart and substitute the desired coil voltage suffix for the Δ. AC and DC operated contactors DO NOT have the same magnet structure. Therefore, DC coils will not fit on an AC magnet structure and vice versa.

Coil voltage selection – AC operated for EK110 – EK550

VAC (50Hz)	VAC (60Hz)	Voltage Code
–	24	F
24	–	N
–	48	G
110	120	1
–	208	B
–	240	2
220 – 230	–	J
–	380	Z
380 – 400	440	3
400 – 415	–	M
–	480	4
500	–	5
–	600	6

Consult factory if other voltages are required.

Coil voltage selection – DC operated for EK110 – EK550

VDC	Voltage Code
24	Y
48	W
110	P
125	Q
220	R
440	T

Consult factory if other voltages are required.

Accessories

Surge suppressors for A/AE/AL/EK contactors



RV 5/50



RC 5-1/150

Surge suppression device

Mounting on	Voltage range	Catalog number	List price
AE9 to AE110 AL9 to AL40	12 – 32 VDC 25 – 65 VDC 50 – 90 VDC 77 – 150 VDC 150 – 264 VDC	RT5/32 RT5/65 RT5/90 RT5/150 RT5/264	\$ 30
A9 to A110; AE9 to AE110 AL9 to AL40	24 – 50 VAC/VDC 50 – 133 VAC/VDC 110 – 250 VAC/VDC 250 – 440 VAC/VDC	RV5/50 RV5/133 RV5/250 RV5/440	
A9 to A40	24 – 50 VAC 50 – 133 VAC 110 – 250 VAC 250 – 440 VAC	RC5-1/50 RC5-1/133 RC5-1/250 RC5-1/440	
A45 to A300	24 – 50 VAC 50 – 133 VAC 110 – 250 VAC 250 – 440 VAC	RC5-2/50 RC5-2/133 RC5-2/250 RC5-2/440	52
EK110 to EK210	24 – 48 VAC 110 – 415 VAC	RC-EH250/48 RC-EH250/415	
EK370 to EK550	48 – 110VAC	RC-EH800/110	
EK110 to EK550	24 – 125VDC	RC-EH800/110	
EK370 to EK550	220 – 600VAC	RC-EH800/600	

Technical data

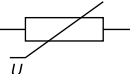
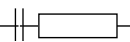
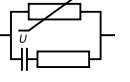
Type	Control circuit	Opening time growth factor	Residual overvoltage or clipping voltage	Remarks
RT 5 /... transil diode 	32 DC 65 DC 90 DC 150 DC 264 DC	2.5 to 3	50 V 100 V 150 V 210 V 390 V	Advantages <ul style="list-style-type: none"> • Good energy absorption • Unpolarized system • Simple, reliable system Drawback <ul style="list-style-type: none"> • A certain delay on drop out which does not however reduce contactor breaking capacity.
Varistor 	RV 5/... 50 AC/DC 133 AC/DC 250 AC/DC 440 AC/DC	1.1 to 1.5	132 V 270 V 480 V 825 V	Advantages <ul style="list-style-type: none"> • High energy absorption; good damping • Unpolarized system Drawback <ul style="list-style-type: none"> • Clipping as from U_{vdr}, thus voltage front up to this point
RC 5-1/... or RC 5-2/... RC-EH 300/... 	see table above AC	1.2 to 3	2 to 3 x U_c	Advantages <ul style="list-style-type: none"> • Very fast clipping • Attenuation of steep fronts and thus of high frequencies • No operating delays
Varistor + RC 	RC-EH ... 800/110 AC/DC 800/600 AC	1.1 to 1.5	205 V 1100 V	Advantages <ul style="list-style-type: none"> • High energy absorption: good damping • Unpolarized system • The RC system damps the voltage front under the U_{vdr} threshold.

* U_{vdr} = Varistor operating voltage (voltage dependent resistor), tolerance $\pm 10\%$

Accessories

Surge suppressors for A/AE/AL/EK contactors

General information

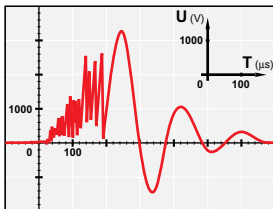

General

The operation of inductive circuits causes overvoltages, in particular on opening of the contactor coil.

The electromagnetic energy stored by the coil during contactor closing is restored on opening in the form of surges, the slope and amplitude of which may rise to several kilovolts. A number of drawbacks are observed ranging from interference on the electronic devices to breakdown of insulators and even destruction of certain sensitive components.

The graph opposite reproduces the oscillogram showing voltage discharges at the terminals of a 42V/50Hz coil without peak clipping. The coil was switched by 8 series-connected poles of a contactor relay.

Following a burst of discharges with a very steep slope a damped oscillation emerges with a peak value of 3500V.

Overvoltage factor

The overvoltage factor k is defined as the ratio of the maximum overvoltage peak value \hat{U}_s to the peak value \hat{U}_c of the coil rated control voltage U_c :

$$k = \frac{\hat{U}_s \text{ max.}}{\hat{U}_c}$$

in DC: $k = \frac{\hat{U}_s \text{ max.}}{U_c}$

or in AC: $k = \frac{\hat{U}_s \text{ max.}}{U_c \sqrt{2}}$

For example the following is obtained for the above graph: $k = \frac{3500}{42 \sqrt{2}} \approx 60$

Surge suppressors

To guard against the harmful effects of these overvoltages, ABB has developed a range of surge suppressors designed to reduce the k factor defined above and to limit or even completely eliminate the high pre-damping voltage frequencies.

Each case is different, but the technical data tolerances and the generous sizing of parts have enabled us to reduce the number of variants.

We have chosen the following solutions: transil diodes, varistors and RC blocks.

Note: A varistor is a resistor whose value increases to a very large extent when a certain voltage is applied at its terminals.

Wiring diagrams

Transil diode

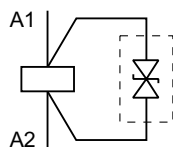

Varistor (only)

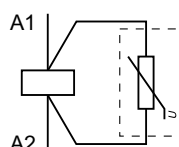

RC type

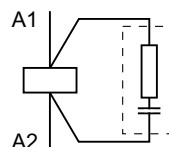

Varistor + RC

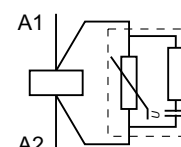

General technical data

The housings and impregnation resins of the surge suppressors are made of flame-resistant materials in accordance with the UL 94 standard.

These systems are not polarized, i.e. d.c. operated devices do not have to be connected in a specific direction.

- Operating temperature: -20 to +70 °C
- Connection to the coil terminals (parallel mounting)
 - For **RT 5**, **RV 5**, **RC 5-1** and **RC 5-2**: clip-on for both fixing and connection.
- Mounting:
 - **RT 5**, **RV 5** and **RC 5**: clipped onto the top part of the contactor base. This mounting method prevents any projections and change in contactor dimensions.
 - **RC-EH**: glued to the top part of the contactor base.

Accessories

Interface relays for A contactors



A30-30-10 + RA 5



RA 5

Interface relays

Mounting on contactor types	Control voltage U_c	Coil voltages	Catalog number	List price
N, A9 – A110	24 VDC	24 – 250V, 50, 60 Hz	RA5-1	\$ 75

NOTE: The interface relays provided for the A contactors can also be used for UA, UA..., RA and GA types.

Application

RA 5-1 interface relays are designed to receive 24 VDC signals delivered by PLC's or other sources with a low output power and restore them with sufficient power to operate the coils of the relevant A9 - A110 contactors or the N control relays.

- IEC only

Description

RA5 interface relays are made up of a miniature electromechanical relay equipped with a N.O. contact and with a low consumption 24 VDC coil.

The interface relay coil is controlled by the PLC while the N.O. contact ensures switching of the power contactor.

Coil switching gives rise to overvoltages which have adverse effects on the electronic devices, insulators and, more generally, on component lifetime. The RA 5-1 is equipped with surge suppressors:

- on the 24 VDC relay coil via a diode
- on the power contactor coil via a varistor.

Furthermore, the RA 5-1 are protected against relay pole reversal by a diode inserted between the E1 and E2 input terminals.

Connection

The "E1+" and "E2-" input terminals must be connected, according to their polarity, to the PLC output.

The RA 5 is equipped with two terminal pads for connection to the A1 and A2 terminals of the contactor coil. This coil is supplied between the A0 and A2 terminals of the RA 5.

Mounting

- RA5: terminal pads clamped inside the contactor coil terminals.

RA 5-1 interface relay for the A 9 – A 110 contactors and N control relays

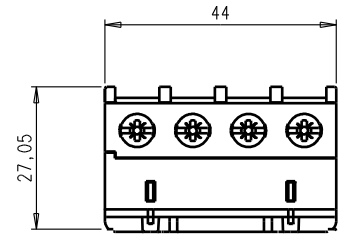
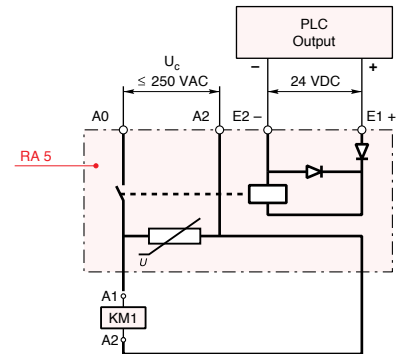

Accessories

Interface relay technical data

Across the line
contactors

1

General technical data

Compliance with standards		IEC 60255-5
Rated insulation voltage U_i according to IEC 60947-4-1	V a.c.	250
Permissible ambient temperature:		
– for free air operation:		
– at $U_c = 24$ V d.c. (between E1 and E2)	°C	-25 ... +70
– from 0.85 to 1.1 U_c	°C	-25 ... +55
– for storage	°C	-40 ... +70
Climatic withstand		Complies with that of associated contactors
Operating altitude	m	≤ 3000
Mounting position		No limitation
Fixing		Using the contactor A1 and A2 terminal connecting parts
Connecting terminals (delivered in open position)		M3.5 (+,-) pozidriv 2 screws with cable clamp
Connecting capacity (min. ... max.)		
– rigid solid	2 x mm²	1 ... 4
– flexible with cable end	2 x mm²	0.75 ... 2.5
Tightening torque		
– recommended	Nm	1.00
– max.	Nm	1.20
Degree of protection according to IEC 60947-1 / EN 60947-1 and IEC 60529 / EN 60529		Protection against direct contact in acc. with EN 50274 RA5-1 wired and mounted on the associated contactor

Working data

Surge suppression:		
– for contactor coil		Varistor
– for interface relay coil		Diode
Protection against polarity reversal between terminals E1 and E2		Diode
Interface relay operating time	ms	Closing and drop-out ≤ 10
Total operating time, interface relay + contactor:		
– between energization and:		
N.O. contact closing	ms	20 ... 37
N.C. contact opening	ms	17 ... 32
– between de-energization and:		
N.O. contact opening	ms	17 ... 25
N.C. contact closing	ms	20 ... 28

Electrical input data

Control voltage (E1 and E2 terminals) U_c		
– rated value	V d.c.	24
– max. range at ambient temperature 20 °C	V d.c.	19 ... 30
Max. consumption for $U_c = 24$ V d.c., $\theta = 20$ °C	W	0.3
"0" status (relay open) for U_c or I_c	V d.c. mA	≤ 2.4 < 1
"1" status (relay closed) for U_c	V d.c.	≥ 19
Max. short supply interruption immunity time	ms	2

Electrical output data

Switching voltage (A0 and A2 terminals)	V a.c.	≤ 250
Electrical durability million of operating cycles		2 (600 cycles/h) on A 9 ... A 75 contactors or N... contactor relay 0.5 (600 cycles/h) on A 95 and A 110 contactors

Accessories for A contactors TE5S electronic timer for wye-delta starters



TE5S-*

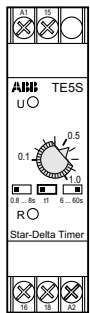
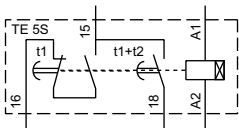
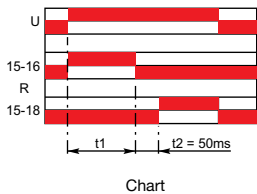

Front face

Electronic timer

For contactors	Rated control voltage U_c V	Packing piece	Unit weight kg	Catalog number	List price
A9 – AF750	24 AC/DC	1	0.080	TE5S-24	\$ 120
	110 – 120 AC	1	0.080	TE5S-120	
	220 – 240 AC	1	0.080	TE5S-240	
	380 – 440 AC	1	0.080	TE5S-440	

Application

Utilization

When used in wye-delta starters, the **TE5S** lags the wye connection and provides a lapse of 50 ms before the switchover to the delta connection.

Description

According to the type of device chosen, the electronic circuit has a 24 VAC/VDC, 110 – 120 VAC or 220 – 230 VAC supply. An output relay with reversing contact ensures high current switching. A two-position switch allows selection of one of the two time delay ranges: 0.8 to 8 s or 6 to 60 s. The 0.1 to 1.0 adjustable knob allows an initial setting without steps within the previously selected range which can then be adjusted using a stopwatch.

Note: We recommend that you allow for temperature drift for the final adjustment of the time delay setting. Drift: -0.2% per $^{\circ}\text{C}$. For example, a setting made at 20°C will yield a time delay shorter by 7% at 55°C in an enclosure. (-0.2% per $^{\circ}\text{C}$ i.e. $-0.2 \times 35 = -7\%$).

The TE5S, which is not affected by these settings, establishes a fixed "lapse" of 50 ms between the opening of contact 15 – 16 and the closing of contact 15 – 18. It is this time delay that prevents from arc short-circuit during wye to delta switching.

Operation

On energization, the green U indicator light (voltage applied) comes on. Contact 15 – 16 then immediately moves to the closed position.

Count-down of the programmed time immediately commences.

When the time delay has elapsed, contact 15 – 16 opens and at the same time the 50 ms lapse, t_2 , begins after which contact 15 – 18 moves to the closed position. The yellow R indicator light comes on.

On de-energization, the U and R indicator lights go out and, after the 250 ms resetting time, the device is ready for a new cycle.

Mounting

Mounts on 35mm DIN rail.

Accessories for A contactors TE5S electronic timer for wye-delta starters, technical data

Across the line
contactors

1

Technical Data





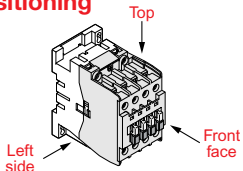

Types	TE5S-24	TE5S-120	TE5S-240	TE5S-440
Compliance with standards	IEC 60947-5-1, EN 60947-5-1			
Rated insulation voltage U_i according to IEC 60947-5-1	V	440		
Rated operational voltage U_e according to IEC 60947-5-1	V d.c. V a.c.	24 24 ... 240		– 440
Conventional free air thermal current I_{th}	A	10		
Rated operational current I_e acc. to IEC 60947-5-1				
AC-15	24-120 V a.c.	A	5	–
	220-240 V a.c.	A	4	–
	380-440 V a.c.	A	–	3
DC-13	24 V d.c.	A	4	–
Short-circuit protection - gG type fuses	A	10		
Rated supply voltage U_c	V d.c. V a.c.	24 24	– 110 ... 120	– 220 ... 240
– Rated frequency limits	Hz	48 ... 63		
– Supply voltage range		0.85 ... 1.1 U_c		
– Overvoltage protection		Built-in varistor		
– Load factor	%	100		
– Average consumption	– in d.c. W – in a.c. VA	0.7 1.5	– 3.5	– 6.5
Time delay range (t_1) selected by switch	s	0.8 ... 8 and 6 ... 60		
– Temperature drift	% per °C	-0.2		
– Mechanical setting accuracy		±15 % of the setting range		
– On-load reiteration accuracy under constant conditions		±2 % after 1 million operating cycles		
Minimum time lapse (t_2)	ms	50		
Min. time lapse after 1 million operating cycles	ms	40		
Resetting time (maximum)	ms	250		
Front panel display:		Energization		Output relay activated
– green indicator light				
– yellow indicator light				
Permissible air temperature				
– for operation	°C	-25 ... +60		
– for storage	°C	-40 ... +85		
Vibration withstand acc. to IEC 60068-2-6, EN 60068-2-6		3 g from 10 to 300 Hz in the 3 directions		
Shock withstand acc. to IEC 60068-2-27, EN 60068-2-27		20 g / 11 ms in directions A and C 15 g / 11 ms in direction B		
Electrical durability	in millions of op. cycles	1		
Mechanical durability	in millions of op. cycles	5		
On-load maximum switching frequency	cycles/h	720		600
Fixing on mounting rail acc. to IEC/EN 60715		35 x 7.5 or 35 x 15		
Connecting terminals		(+,-) pozidriv 1 screw		
Connecting capacity				
– rigid solid	1 or 2 x mm ²	1 ... 2.5		
– flexible with cable end	1 or 2 x mm ²	0.75 ... 2.5		
Tightening torque	Nm	0.6 ... 0.8 max.		
Degree of protection according to IEC 60947-1 / EN 60947-1 and IEC 60529 / EN 60529	Terminals	IP 20		

Accessories

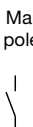
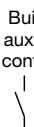
Possible accessory combinations for A contactors

Positioning 	Accessories – Front face mounting			Accessories – Side mounting		
	Auxiliary contacts 1 – pole 4 – pole		Pneumatic timers	Auxiliary contacts	Electrical or mechanical interlock ^①	
	CA5-10 or CA5-01	CA5-40 or CA5-22 or CA5-31	TP – D or TP – I	CAL 5-11 CAL18-11 CAL18-11B	VE5-1 or VM 5-1	VE 5-2 VM300H VM300/460H VM750H

Configurations of accessories are different depending on whether front or side mounted.

N Contactor relays A and AE Contactors	Accessories – Front mounting					Accessories – Side mounting	
	Type	Main poles	Built-in auxiliary contacts	Auxiliary contact blocks 1-pole CA5-	Auxiliary contact blocks 4-pole CA5-	TP - A Pneumatic timer block	Auxiliary contact Blocks 2-pole CAL5-11, CAL18-11
							
A9 – A26	- 3 0 - 1 0		1 to 4 CA5- 1-pole blocks	OR 1 CA5- 4-pole block	OR 1 TP - A block	+ 1 to 2 CAL5-11 blocks	OR 1 VM/E 5-1 block + 1 CAL5-11 block
A9 – A26	- 3 0 - 0 1 ^①		1 to 4 CA5- 1-pole blocks	OR 1 CA5- 4-pole block	OR -	OR 1 CAL5-11 block	OR 1 VM/E 5-1 block + 1 CAL5-11 block
A9 – A26	- 4 0 - 0 0		1 to 4 CA5- 1-pole blocks	OR 1 CA5- 4-pole block	OR -	OR 1 CAL5-11 block	OR 1 VM/E 5-1 block + 1 CAL5-11 block
A9 – A26	- 2 2 - 0 0 ^②		1 to 4 CA5- 1-pole blocks	OR 1 CA5- 4-pole block	OR -	OR 1 CAL5-11 block	OR 1 VM/E 5-1 block + 1 CAL5-11 block
AE9 – AE26	- 3 0 - 0 0		-	-	-	+ 1 to 2 CAL5-11 blocks	OR 1 VM/E 5-1 block + 1 CAL5-11 block
AL9 – AL26	- 3 0 - 1 0		1 to 5 CA5- 1-pole blocks	OR 1 CA5- 4-pole block + 1 CA5- 1-pole block	OR 1 TP - A block + 1 CA5- 1-pole block	+ 1 to 2 CAL5-11 blocks	OR 1 VM/E 5-1 block + 1 CAL5-11 block
AL9 – AL26	- 3 0 - 0 1		1 to 5 CA5- 1-pole blocks	OR 1 CA5- 4-pole block + 1 CA5- 1-pole block	OR -	OR 1 CAL5-11 block	OR 1 VM/E 5-1 block + 1 CAL5-11 block
AL9 – AL16	- 4 0 - 0 0		1 CA5- 1-pole block	-	-	+ 1 to 2 CAL5-11 blocks	OR 1 VM/E 5-1 block + 1 CAL5-11 block
AL9 – AL16	- 2 2 - 0 0		1 to 6 CA5- 1-pole blocks	OR 1 CA5- 4-pole block + 2 CA5- 1-pole blocks	OR 1 TP - A block + 2 CA5- 1-pole blocks	+ 1 to 2 CAL5-11 blocks	OR 1 VE5-2 block + 1 CAL5-11 block
AL26	- 4 0 - 0 0		2 CA5- 1-pole blocks	-	-	2 CAL18-11 blocks	OR 1 VE5-2 + CAL5-11
AL26	- 2 2 - 0 0		1 to 6 CA5- 1-pole blocks	OR 1 CA5- 4-pole block + 2 CA5- 1-pole blocks	OR -	+ 1 to 2 CAL5-11 blocks	OR 1 VM/E 5-1 block + 1 CAL5-11 block
A9 – A16	- 3 0 - 2 2		1 to 6 CA5- 1-pole blocks	OR 1 CA5- 4-pole block + 2 CA5- 1-pole blocks	OR 1 TP - A block + 2 CA5- 1-pole blocks	+ 1 to 2 CAL5-11 blocks	OR 1 VM/E 5-1 block + 1 CAL5-11 block
A9 – A26	- 3 0 - 3 2		2 CA5- 1-pole blocks	-	-	+ 1 to 2 CAL5-11 blocks	OR 1 VE5-2 block + 1 CAL5-11 block
A30, A40	- 3 0 - 1 0		1 to 6 CA5- 1-pole blocks	OR 1 CA5- 4-pole block + 2 CA5- 1-pole blocks	OR 1 TP - A block + 2 CA5- 1-pole blocks	+ 1 CAL5-11 block 1 CAL5-11 block 1 CAL5-11 block	OR 1 VE5-2 block
A30, A40	- 3 0 - 0 1		1 to 6 CA5- 1-pole blocks	OR 1 CA5- 4-pole block + 2 CA5- 1-pole blocks	OR 1 TP - A block + 2 CA5- 1-pole blocks	+ 1 CAL5-11 block 1 CAL18-11 block	OR 1 VE5-2 block
AE30, AE40	- 3 0 - 1 0		1 to 6 CA5- 1-pole blocks	OR 1 CA5- 4-pole block + 2 CA5- 1-pole blocks	OR 1 TP - A block + 2 CA5- 1-pole blocks	+ 1 CAL5-11 block 1 CAL18-11 block	OR 1 VE5-2 block
AE30, AE40	- 3 0 - 0 1		1 to 6 CA5- 1-pole blocks	OR 1 CA5- 4-pole block + 2 CA5- 1-pole blocks	OR 1 TP - A block + 2 CA5- 1-pole blocks	+ 1 CAL5-11 block 1 CAL18-11 block	OR 1 VE5-2 block
AE30, AE40	- 3 0 - 1 0		1 to 6 CA5- 1-pole blocks	OR 1 CA5- 4-pole block + 2 CA5- 1-pole blocks	OR 1 TP - A block + 2 CA5- 1-pole blocks	+ 1 CAL5-11 block 1 CAL18-11 block	OR 1 VE5-2 block
AE30, AE40	- 3 0 - 0 1		1 to 6 CA5- 1-pole blocks	OR 1 CA5- 4-pole block + 2 CA5- 1-pole blocks	OR 1 TP - A block + 2 CA5- 1-pole blocks	+ 1 CAL5-11 block 1 CAL18-11 block	OR 1 VE5-2 block
A30, A40	- 3 0 - 3 2		1 to 6 CA5- 1-pole blocks	OR 1 CA5- 4-pole block + 2 CA5- 1-pole blocks	OR 1 TP - A block + 2 CA5- 1-pole blocks	+ 1 CAL5-11 block 1 CAL18-11 block	OR 1 VE5-2 block
A50 – A75	- 3 0 - 0 0		1 to 6 CA5- 1-pole blocks	OR 1 CA5- 4-pole block + 2 CA5- 1-pole blocks	OR 1 TP - A block + 2 CA5- 1-pole blocks	+ 1 CAL5-11 block 1 CAL18-11 block	OR 1 VE5-2 block
A45 – A75	- 4 0 - 0 0		1 to 6 CA5- 1-pole blocks	OR 1 CA5- 4-pole block + 2 CA5- 1-pole blocks	OR 1 TP - A block + 2 CA5- 1-pole blocks	+ 1 CAL5-11 block 1 CAL18-11 block	OR 1 VE5-2 block
A45, A75	- 2 2 - 0 0 ^②		1 to 6 CA5- 1-pole blocks	OR 1 CA5- 4-pole block + 2 CA5- 1-pole blocks	OR 1 TP - A block + 2 CA5- 1-pole blocks	+ 1 CAL5-11 block 1 CAL18-11 block	OR 1 VE5-2 block
A95, A110	- 3 0 - 0 0		1 to 6 CA5- 1-pole blocks	OR 1 CA5- 4-pole block + 2 CA5- 1-pole blocks	OR 1 TP - A block + 2 CA5- 1-pole blocks	+ 1 CAL5-11 block 1 CAL18-11 block	OR 1 VE5-2 block
A50 – A75	- 3 0 - 2 2		1 to 6 CA5- 1-pole blocks	OR 1 CA5- 4-pole block + 2 CA5- 1-pole blocks	OR 1 TP - A block + 2 CA5- 1-pole blocks	+ 1 CAL5-11 block 1 CAL18-11 block	OR 1 VE5-2 block
A95, A110	- 3 0 - 2 2		1 to 6 CA5- 1-pole blocks	OR 1 CA5- 4-pole block + 2 CA5- 1-pole blocks	OR 1 TP - A block + 2 CA5- 1-pole blocks	+ 1 CAL5-11 block 1 CAL18-11 block	OR 1 VE5-2 block
AE50 – AE75	- 3 0 - 0 0		1 to 6 CA5- 1-pole blocks	OR 1 CA5- 4-pole block + 2 CA5- 1-pole blocks	OR 1 TP - A block + 2 CA5- 1-pole blocks	+ 1 CAL5-11 block 1 CAL18-11 block	OR 1 VE5-2 block
AE45 – AE75	- 4 0 - 0 0		1 to 6 CA5- 1-pole blocks	OR 1 CA5- 4-pole block + 2 CA5- 1-pole blocks	OR 1 TP - A block + 2 CA5- 1-pole blocks	+ 1 CAL5-11 block 1 CAL18-11 block	OR 1 VE5-2 block
AE45, AE75	- 2 2 - 0 0 ^②		1 to 6 CA5- 1-pole blocks	OR 1 CA5- 4-pole block + 2 CA5- 1-pole blocks	OR 1 TP - A block + 2 CA5- 1-pole blocks	+ 1 CAL5-11 block 1 CAL18-11 block	OR 1 VE5-2 block
AE95, AE110	- 3 0 - 0 0		1 to 6 CA5- 1-pole blocks	OR 1 CA5- 4-pole block + 2 CA5- 1-pole blocks	OR 1 TP - A block + 2 CA5- 1-pole blocks	+ 1 CAL5-11 block 1 CAL18-11 block	OR 1 VE5-2 block
A50 – A75	- 3 0 - 1 1		1 to 6 CA5- 1-pole blocks	OR 1 CA5- 4-pole block + 2 CA5- 1-pole blocks	OR 1 TP - A block + 2 CA5- 1-pole blocks	+ 1 CAL5-11 block 1 CAL18-11 block	OR 1 VE5-2 block
AE50, AE75	- 3 0 - 1 1		1 to 6 CA5- 1-pole blocks	OR 1 CA5- 4-pole block + 2 CA5- 1-pole blocks	OR 1 TP - A block + 2 CA5- 1-pole blocks	+ 1 CAL5-11 block 1 CAL18-11 block	OR 1 VE5-2 block
A95, A110	- 3 0 - 1 1		1 to 6 CA5- 1-pole blocks	OR 1 CA5- 4-pole block + 2 CA5- 1-pole blocks	OR 1 TP - A block + 2 CA5- 1-pole blocks	+ 1 CAL5-11 block 1 CAL18-11 block	OR 1 VE5-2 block
AE95, AE110	- 3 0 - 1 1		1 to 6 CA5- 1-pole blocks	OR 1 CA5- 4-pole block + 2 CA5- 1-pole blocks	OR 1 TP - A block + 2 CA5- 1-pole blocks	+ 1 CAL5-11 block 1 CAL18-11 block	OR 1 VE5-2 block
A145 – AF2050	- 3 0 - 0 0		-	-	-	1 to 2 CAL18-11 blocks + 1 to 2 CAL18-11B blocks	OR 1 CAL18-11 block + 1 CAL18-11B block + VM300H or VM300/460H or VM750H interlock

Contactor mounting configurations (standard from factory)

Auxiliary contacts are mounted on the contactor in the following order:

- Left – 1st
- Right – 2nd
- Top – 3rd (L to R)

^① In mounting position 5 (see page 1.36), there should be no more than 2 "N.C." front-mounted auxiliary contacts – The CAL 5-11 side-mounted blocks offer additional "N.C." contacts.

^② Whatever the mounting position (see page 1.36), there should be no more than 2 "N.C." front-mounted auxiliary contacts – The CAL 5-11 side-mounted blocks offer additional "N.C." contacts.

Accessories

Terminal markings

CA/CC/CAL/CCL auxiliary contacts

One pole auxiliary contacts (top mounted)

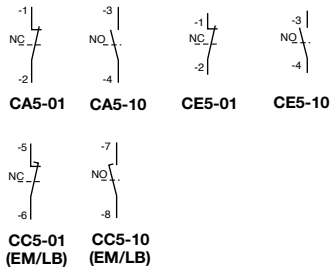

Legend
L.H.S. = Left hand side mounted
R.H.S. = Right hand side mounted
EM/LB = Early make / Late break

Two pole auxiliary contacts

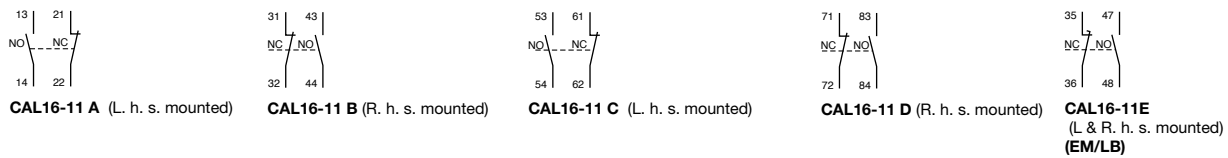
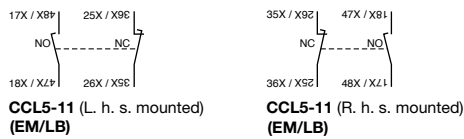
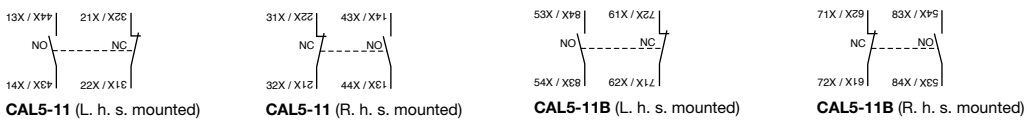

Four pole auxiliary contacts (Top mounted)

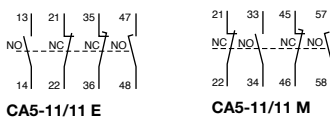
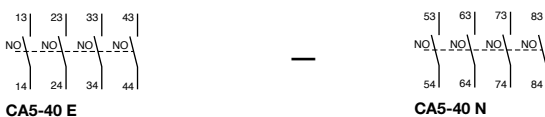
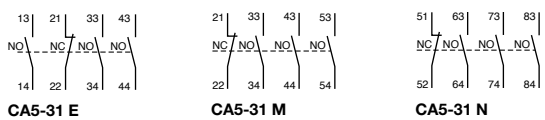
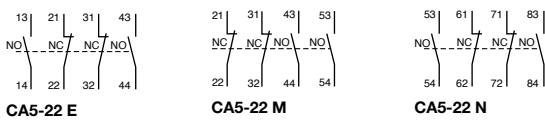
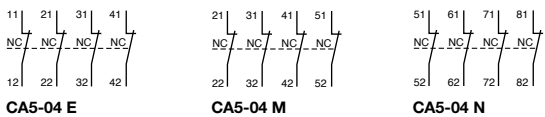

Accessories

Terminal markings & positioning for A/UA contactors

Standard devices without addition of auxiliary contacts

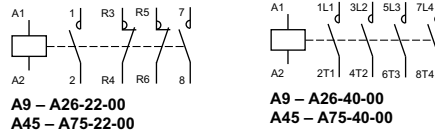
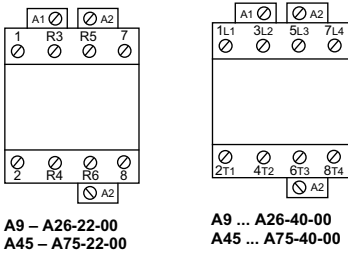
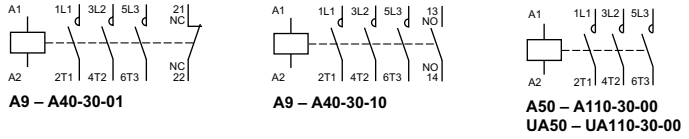
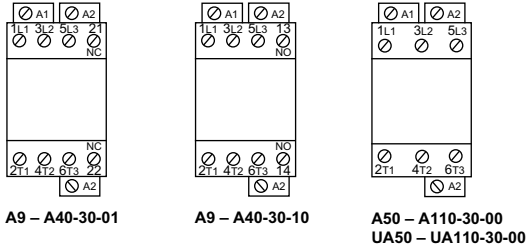

Standard 3 pole devices with factory mounted auxiliary contacts

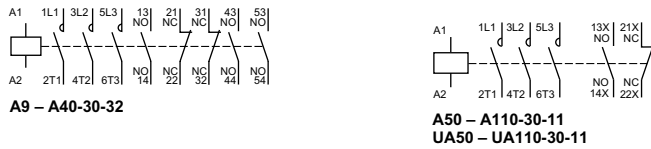
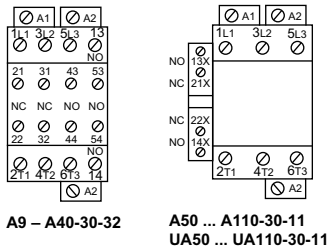
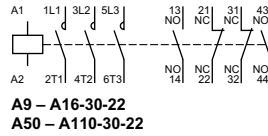
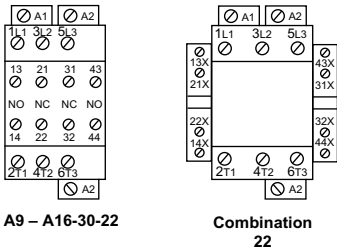

Other possible contact combinations with auxiliary contacts added by the user

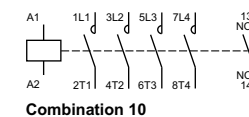
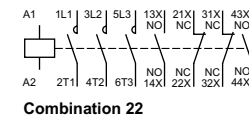
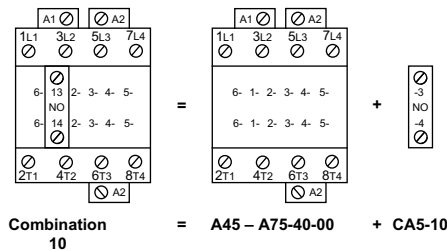
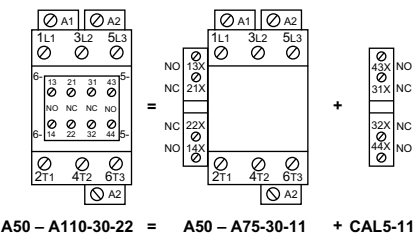
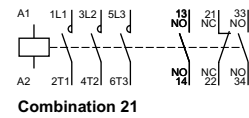
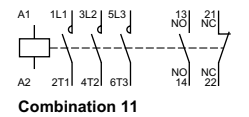
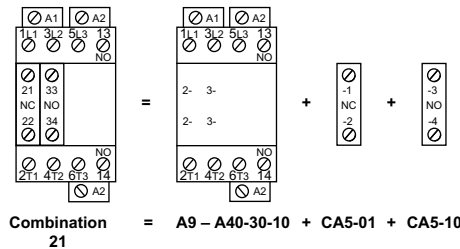
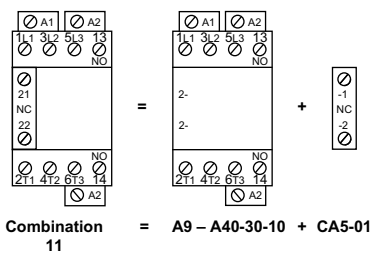

Accessories

Terminal marking and positioning for AE/AL contactors

AE Contactors – D.C. operated

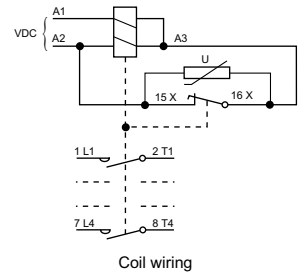
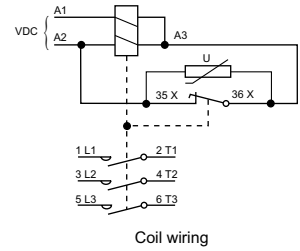
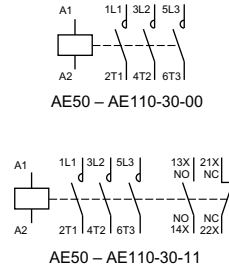
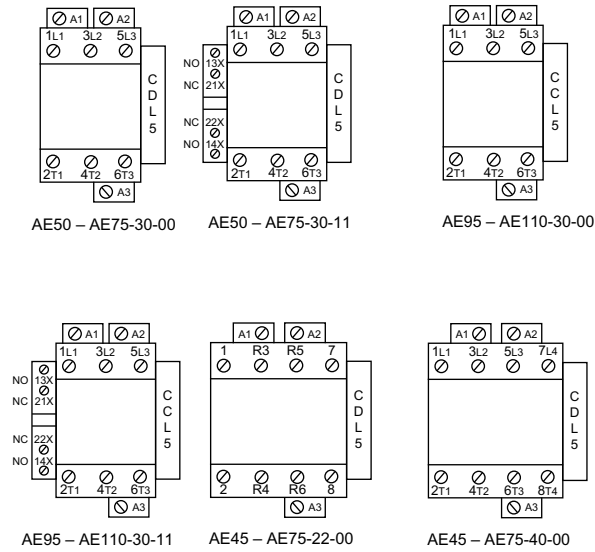

AL Contactors – D.C. operated

Standard devices without addition of auxiliary contacts

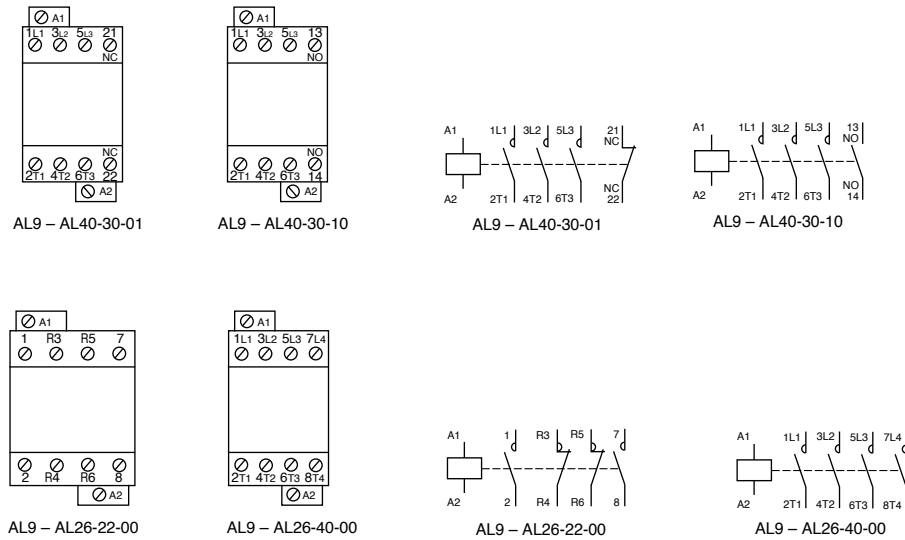

Other possible contact combinations with auxiliary contacts added by the user

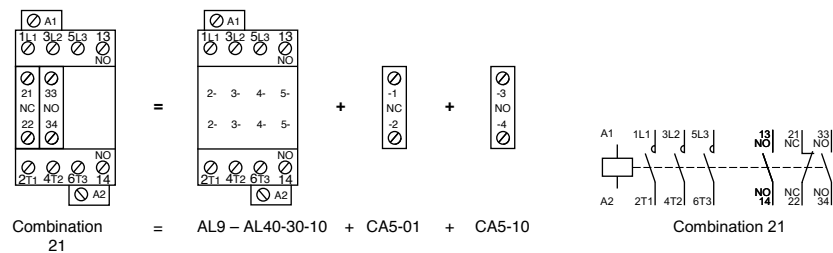

UL & CSA Technical data

A/AE9 – A/AE/AF110, AL9 – AL40

AC & DC operated

ABB contactor frame size		A/AE/AL 9	A/AE/AL 12	A/AE/AL 16	A/AE/AL 26	A/AE/AL 30	A/AE/AL 40	A/AE/AF 45	A/AE/AF 50	A/AE/AF 63	A/AE/AF 75	A/AE/AF 95	A/AE/AF 110
NEMA size		00	—	0	1	1P	—	—	2	—	3	—	—
Number of poles		3 OR 4	3	3 OR 4	3 OR 4	3	3	4	3 OR 4	3	3 OR 4	3	3
AC rating information													
NEMA cont. amp rating		9	—	18	27	36	—	—	45	—	90	—	—
NEMA maximum H.P. ratings													
115 VAC		1/3	—	1	2	3	—	—	3	—	—	—	—
230 VAC		1	—	2	3	5	—	—	7.5	—	—	—	—
NEMA maximum H.P. ratings													
200 VAC		1.5	—	3	7.5	—	—	—	10	—	25	—	—
230 VAC		1.5	—	3	7.5	—	—	—	15	—	30	—	—
460/575 VAC		2	—	5	10	—	—	—	25	—	50	—	—
U.L. general purpose current		40°C	21	25	30	40	50	60	65	80	90	105	125
Max. 3 Ph Switching motor loads		A	9	11	17	28	34	42	—	54	65	80	95
U.L. maximum H.P. ratings													
115 VAC		1/2	3/4	2HP, 24A	2	3	3	—	3	5	7.5	7.5	10
230 VAC		2	2	3	5	7.5	7.5	—	7.5	10	15	20	25
U.L. maximum H.P. ratings													
200-208 VAC		2	3	5	7.5	10	10	—	15	20	25	30	30
220-240 VAC		2	3	5	10	10	15	—	20	25	30	30	40
440-480 VAC		5	7.5	10	20	25	30	—	40	50	60	60	75
550-600 VAC		7.5	10	15	25	30	40	—	50	60	75	75	100
U.L. maximum H.P. ratings													
120 VDC		1	1.5	2	3	3	5	—	7.5	10	10	—	—
240 VDC		2	3	3	5	7.5	10	—	15	20	25	—	—
Lighting — ballast and incandescent		600VAC	15	15	20 ①	35	50	60	65	65	85	105	120
Resistive heating applications		600VAC	15	15	20	35	50	60	65	65	85	105	—
CSA Elevator ratings													
220 – 240VAC		3 phase	—	—	5	—	—	10	—	15	—	20	20
440 – 480VAC		3 phase	—	—	10	—	—	20	—	30	—	30	40
550 – 600VAC		3 phase	—	—	10	—	—	20	—	30	—	40	50
230VAC		1 phase	—	—	2	—	—	5	—	7.5	—	10	10
Auxiliary contacts													
NEMA rating		AC	A600	A600	A600	A600	A600	—	A600	A600	A600	A600	A600
AC rated voltage		VAC	600	600	600	600	600	—	600	600	600	600	600
AC thermal rated current		A	10	10	10	10	10	—	10	10	10	10	10
AC maximum volt-ampere making		VA	7200	7200	7200	7200	7200	—	7200	7200	7200	7200	7200
AC maximum volt-ampere breaking		VA	720	720	720	720	720	—	720	720	720	720	720
NEMA rating		DC	P600	P600	P600	P600	P600	—	P600	P600	P600	P600	P600
DC rated voltage		VDC	600	600	600	600	600	—	600	600	600	600	600
DC thermal rated current		A	5	5	5	5	5	—	5	5	5	5	5
DC Maximum make-break		A	0.2	0.2	0.2	0.2	0.2	—	0.2	0.2	0.2	0.2	0.2
Approximate weight													
Contactor		lbs.	0.7	0.7	0.7	1.01	1.2	2.25	2.25	2.25	2.25	3.5	5
Starter		lbs.	1.04	1.04	1.04	1.35	1.54	3	—	3	3	6	7
Terminal wire range													
Number of wires per phase		AWG	18-10	18-10	18-10	12-8	8-4	8-4	8-1	8-1	8-1	6-2/0	6-2/0
			2	2	2	2	2	2	1	1	1	1	1
Maximum short circuit ratings													
MCCB, MCP, Amps/kA		480VAC	50/35	50/35	50/35	100/35	150/65	150/65	—	150/85	250/85	250/85	250/85
		600VAC	10/35	10/35	10/35	100/35	150/25	150/25	—	—	—	250/35	250/35
Fuse, Amps — type/kA		600VAC	30J/200	30J/200	30J/200	60J/200	60J/200	100J/200	—	100J/200	200J/200	200J/200	200J/200

Mounting positions

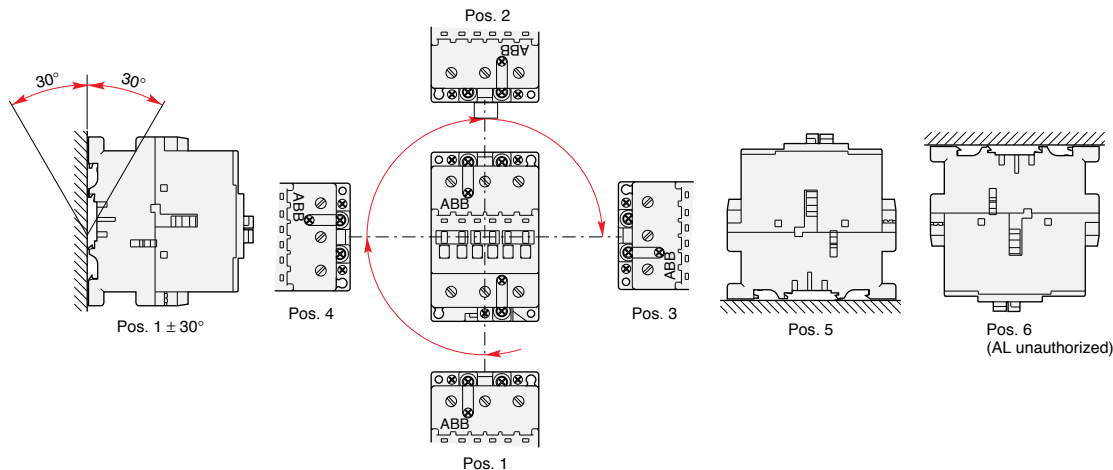

UL & CSA Technical data

A/AF145 – AF750

AC & DC operated

Across the line
contactors

1

ABB contactor frame size		A/AF 145	A/AF 185	A/AF 210	A/AF 260	A/AF 300	AF 400	AF 460	AF 580	AF 750
NEMA size		4	—	—	5	—	—	6	—	7
Number of poles		3	3	3	3	3	3	3	3	3
AC rating information										
NEMA maximum H.P. ratings		3 phase								
200	VAC	40	—	—	75	—	—	150	—	—
230	VAC	50	—	—	100	—	—	200	—	300
460/575	V	100	—	—	200	—	—	400	—	600
U.L. general purpose current		40°C								
Max. 3 Ph switching motor loads		Amps								
U.L. maximum H.P. ratings		1 phase								
115	VAC	10	15	—	—	—	—	—	—	—
230	VAC	25	30	40	50	—	—	—	—	—
U.L. maximum H.P. ratings		3 phase								
200–208	VAC	40	50	60	75	100	125	150	200	250
220–240	VAC	50	60	75	100	100	150	200	250	300
440–480	VAC	100	125	150	200	250	350	400	500	600
550–600	VAC	125	150	200	250	300	400	500	600	700
Lighting – ballast and incandescent	600VAC	200	—	300	—	400	—	—	—	—
CSA Elevator ratings										
220 – 240VAC	3 phase	—	—	40	50	60	—	—	—	—
240 – 480VAC	3 phase	Consult factory	Consult factory	75	100	125	—	—	—	—
550 - 600VAC	3 phase	—	—	100	125	150	—	—	—	—
230VAC	1 phase	—	—	—	—	—	—	—	—	—
Auxiliary contacts										
NEMA rating	AC	A600	A600	A600	A600	A600	A600	A600	A600	A600
AC rated voltage	VAC	600	600	600	600	600	600	600	600	600
AC thermal rated current	A	10	10	10	10	10	10	10	10	10
AC maximum volt—ampere making	VA	7200	7200	7200	7200	7200	7200	7200	7200	7200
AC maximum volt—ampere breaking	VA	720	720	720	720	720	720	720	720	720
NEMA rating	DC	P600	P600	P600	P600	P600	P600	P600	P600	P600
DC rated voltage	VDC	600	600	600	600	600	600	600	600	600
DC thermal rated current	A	5	5	5	5	5	5	5	5	5
DC Maximum make—break	A	0.2	0.2	0.2	0.2	0.2	0.2	0.2	0.2	0.2
Approximate weight										
Contactor	lbs.	7.1	7.1	13	13	13	26	26	33	33
Starter	lbs.	9.11	9.11	17.67	17.67	17.67	35	35	45	45
Terminal wire range										
Number of wires per phase	AWG	6-250MCM 1	6-250MCM 1	4-400MCM 1	4-400MCM 1	4-500MCM 2	250-500MCM 2	250-500MCM 2	2/0-500MCM 2	2/0-500MCM 3
Maximum short circuit ratings										
MCCB,MCP,amps/kA	480VAC	400/85	400/85	800/85	800/85	800/85	800/80	800/80	1200/42	1200/42
MCCB,MCP,amps/kA	600VAC	400/35	400/35	800/35	800/35	800/35	800/42	800/42	—	—
Fuse, amps—Type/kA	600VAC	400J/200	400J/200	600J/200	600J/200	600J/200	1000L/80	1000L/80	1200L/80	1200L/80

UL & CSA Technical data

AF1350 – AF1650

AC & DC operated

ABB contactor frame size		AF 1350	AF 1650
NEMA size		—	8
Number of poles		3	3
AC rating information			
NEMA maximum H.P. ratings	3 phase		
200	VAC	—	—
230	VAC	—	450
460/575	V	—	900
U.L. general purpose current			
40°C		1350	1650
Max. 3 Ph switching motor loads		960	1080
U.L. maximum H.P. ratings			
1 phase			
115	VAC	—	—
230	VAC	—	—
U.L. maximum H.P. ratings			
3 phase			
200–208	VAC	—	—
220–240	VAC	400	450
440–480	VAC	800	900
550–600	VAC	900	1000
Auxiliary contacts			
NEMA rating	AC	A600	A600
AC rated voltage	VAC	600	600
AC thermal rated current	A	10	10
AC maximum volt—ampere making	VA	7200	7200
AC maximum volt—ampere breaking	VA	720	720
NEMA rating	DC	P600	P600
DC rated voltage	VDC	600	600
DC thermal rated current	A	5	5
DC Maximum make—break	A	0.2	0.2
Approximate weight			
Contactor	lbs.	75	75
Starter	lbs.	—	—
Terminal wire range			
	AWG	1/0-750 MCM	1/0-750 MCM
Number of wires per phase		4	6
Maximum short circuit ratings			
MCCB,MCP,amps/kA	480VAC	2000/42	2000/42
MCCB,MCP,amps/kA	600VAC	—	—
Fuse, amps—Type/kA	600VAC	1600L/82	2000L/82

UL/CSA & IEC Technical data

A/AE9 – A/AE/AF/TAE110

Across the line
contactors

1

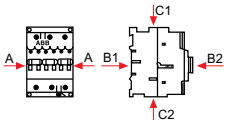
Contactor types: A..., AE... AF..., TAE...	9	12	16	26	30	40	45	50	63	75	95	110																		
Rated insulation voltage U_i according to IEC 60947-4-1	-	-	-	-	-	-	1000	1000	1000	1000	1000	1100																		
according to UL/CSA	-	-	-	-	-	-	600	600	600	600	600	600																		
Rated impulse withstand voltage U_{imp}	8																													
Standards	Devices complying with international standards IEC 60947-1 / 60947-4-1 and European standards EN 60947-1 / 60947-4-1																													
Air temperature close to contactor	see "Conditions for use" page 1.50, for control voltage limits and authorized mounting positions																													
- fitted with thermal O/L relay	-25 to +55																													
- without thermal O/L relay	-40 to +70 (55 max. for TAE... contactors)																													
- for storage	-60 to +80																													
Climatic withstand 68-2-30	acc. to IEC 60068-2-30 and 60068-2-11 - UTE C 63-100 specification II											acc. to IEC																		
Operating altitude	m ≤ 3000																													
Shock withstand acc. IEC 60068-2-27 and EN 60068-2-27 Mounting position 1 (see page 1.50)	<p>1/2 sinusoidal shock for 11 ms: no change in contact position</p> <table border="1"> <thead> <tr> <th>Shock direction</th> <th>Making position</th> <th>Breaking position</th> </tr> </thead> <tbody> <tr> <td>A</td> <td>20 g</td> <td>20 g</td> </tr> <tr> <td>B1</td> <td>10 g</td> <td>5 g ①</td> </tr> <tr> <td>B2</td> <td>15 g ②</td> <td>15 g ②</td> </tr> <tr> <td>C1</td> <td>20 g</td> <td>20 g</td> </tr> <tr> <td>C2</td> <td>20 g</td> <td>20 g</td> </tr> </tbody> </table>												Shock direction	Making position	Breaking position	A	20 g	20 g	B1	10 g	5 g ①	B2	15 g ②	15 g ②	C1	20 g	20 g	C2	20 g	20 g
Shock direction	Making position	Breaking position																												
A	20 g	20 g																												
B1	10 g	5 g ①																												
B2	15 g ②	15 g ②																												
C1	20 g	20 g																												
C2	20 g	20 g																												
												Not valid for DIN-rail mounting																		

① 3 g for AF 45-22, AE 45-22, AF 75-22 and AE 75-22.
② 10 g for AF 45-22, AE 45-22, AF 75-22 and AE 75-22.

UL/CSA & IEC Technical data

A/AF145 – AF1650

A/AF145 – AF750

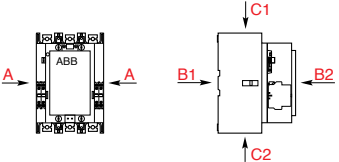
Contactor types:	A...	145	185	210	260	300	-	-	-	-
	AF...	145	185	210	260	300	400	460	580	750
Rated insulation voltage U_i according to IEC 60947-4-1 according to UL/CSA	V					1000 V600				
Rated impulse withstand voltage U_{imp} . Standards	kV					8	Devices complying with international standards IEC 60947-1 / 60947-4-1 and European standards EN 60947-1 / 60947-4-1			
Air temperature close to contactor – fitted with thermal O/L relay – without thermal O/L relay – for storage	°C °C °C	see "Conditions for use" page 1.51 , for control voltage limits and authorized mounting positions								
Climatic withstand		acc. to IEC 60068-2-30								
Operating altitude	m	≤ 3000								
Shock withstand acc. IEC 60068-2-27 and EN 60068-2-27 Mounting position 1 (see page 1.51)		1/2 sinusoidal shock for 30 ms: no change in contact position 5 g in all directions (A, B1, B2, C1, C2)								
										

AF1350 – AF1650

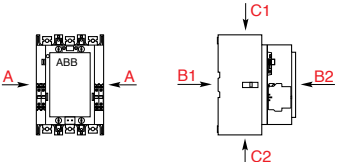
Contactor types:	AF...	1350	1650
Rated insulation voltage U_i according to IEC 60947-4-1 according to UL/CSA	V		1000 600
Rated impulse withstand voltage U_{imp} . Standards	kV		8
		Devices complying with international standards IEC 60947-1 / 60947-4-1 and European standards EN 60947-1 / 60947-4-1	
Air temperature close to contactor – fitted with thermal O/L relay – without thermal O/L relay – for storage		see "Conditions for use" page 1.51 , for control voltage limits and authorized mounting positions	
		°C-25 to +55 °C-40 to +70 °C-40 to +70	
Climatic withstand		acc. to IEC 60068-2-30	
Operating altitude	m	≤ 3000	
Shock withstand acc. IEC 60068-2-27 and EN 60068-2-27 Mounting position 1 (See page 1.51)		1/2 sinusoidal shock for 30 ms: no change in contact position 5 g in all directions (A, B1, B2, C1, C2)	
			

IEC Technical data











A/AE9 – GAE75

DC circuit switching

General

The arc switching on d.c. is more difficult than on a.c.

- For selecting a contactor it is essential to determine the current, the voltage and the L/R time constant of the controlled load.
- For information, typical time constant values are quoted hereafter: non-inductive loads such as resistance furnaces ($L/R \approx 1$ ms), inductive loads such as shunt motors ($L/R \approx 2$ ms) or series motors ($L/R \approx 7.5$ ms).
- The addition of a resistor in parallel with an inductive winding helps in the elimination of the arcs.
- All the poles required for breaking must be connected in series between the load and the source polarity not linked to earth (or chassis).

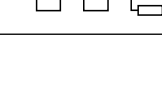
a.c. operated contactors a.c. / d.c. operated (electronic coil interface) d.c. operated contactors	A9 - AE9	A12 - AE12	A16 - AE16	A26 - AE26	A30 - AE30	A40 - AE40	A45 AF45 AE45	A50 AF50 AE50	A63 AF63 AE63	A75 AF75 AE75	GA75 - GAE75	
Utilization category DC-1, $L/R \leq 1$ ms												
	≤ 72 V	A	25	27	30	45	55	60	70	100	110	120
	110 V	A	10	15	20	-	-	-	-	-	-	120
	220 V	A	-	-	-	-	-	-	-	-	-	120
	440 V	A	-	-	-	-	-	-	-	-	-	100
	600 V	A	-	-	-	-	-	-	-	-	-	75
	≤ 72 V	A	25	27	30	45	55	60	70	100	110	120
	110 V	A	25	27	30	45	55	60	70	100	110	120
	220 V	A	10	15	20	-	-	-	-	-	-	-
	≤ 72 V	A	25	27	30	45	55	60	70	100	110	120
	110 V	A	25	27	30	45	55	60	70	100	110	120
	220 V	A	25	27	30	45	55	60	70	100	110	120
	≤ 72 V	A	25	27	30	45	-	-	70	100	-	120
	110 V	A	25	27	30	45	-	-	70	100	-	120
	220 V	A	25	27	30	45	-	-	70	100	-	120
	440 V	A	10	15	20	-	-	-	-	-	-	-
Utilization category DC-3, $L/R \leq 2$ ms												
	≤ 72 V	A	25	27	30	45	55	60	70	100	110	120
	110 V	A	6	7	8	-	-	-	-	-	-	120
	220 V	A	-	-	-	-	-	-	-	-	-	100
	440 V	A	-	-	-	-	-	-	-	-	-	85
	≤ 72 V	A	25	27	30	45	55	60	70	100	110	120
	110 V	A	25	27	30	45	55	60	70	100	110	120
	220 V	A	6	7	8	-	-	-	-	-	-	-
	≤ 72 V	A	25	27	30	45	55	60	70	100	110	120
	110 V	A	25	27	30	45	55	60	70	100	110	120
	220 V	A	25	27	30	45	55	60	70	100	110	120
	≤ 72 V	A	25	27	30	45	-	-	70	100	-	120
	110 V	A	25	27	30	45	-	-	70	100	-	120
	220 V	A	25	27	30	45	-	-	70	100	-	120
	440 V	A	6	7	8	-	-	-	-	-	-	-
Utilization category DC-5, $L/R \leq 7.5$ ms												
	≤ 72 V	A	9	12	16	25	30	40	50	50	63	75
	110 V	A	4	4	4	-	-	-	-	-	-	85
	220 V	A	-	-	-	-	-	-	-	-	-	85
	440 V	A	-	-	-	-	-	-	-	-	-	35
	≤ 72 V	A	25	27	30	45	55	60	70	100	110	120
	110 V	A	10	15	20	30	45	50	70	80	90	100
	220 V	A	4	4	4	-	-	-	-	-	-	-
	≤ 72 V	A	25	27	30	45	55	60	70	100	110	120
	110 V	A	25	27	30	45	55	60	70	100	110	120
	220 V	A	9	12	16	25	30	40	50	50	63	75
	≤ 72 V	A	25	27	30	45	-	-	70	100	-	120
	110 V	A	25	27	30	45	-	-	70	100	-	120
	220 V	A	10	15	20	30	-	-	70	70	-	100
	440 V	A	4	4	4	-	-	-	-	-	-	-









IEC Technical data

A/AF/AE95 – AF750

DC circuit switching

Technical Data

- The tables indicate for the standard contactors the I_g max. operating currents depending on: the utilization category (i.e. L/R) DC-1, DC-3, DC-5 as defined in the IEC 60947-4-1 publication, the operating voltage U_g and the pole coupling details. See page 1.81.
Ampere values quoted in the tables below are valid for a -25 ... +70 °C temperature close to the contactors, as long as the AC-1 Ampere values (see pages 1.45 - 146) for the corresponding ambient temperature are not exceeded.
 - Max. switching frequency: 300 ops/h.
 - For switching higher d.c. ratings, we recommend the use of bar mounted contactors, R series (63 ... 2000 A).
- The selection table for AE 50 ... AE 110 contactors can be used for the TAE 50 ... TAE 110 types.

a.c. operated contactors a.c. / d.c. operated (electronic coil interface) d.c. operated contactors			A95 AF95 AE95	A110 AF110 AE110	A145 AF145 -	A185 AF185 -	A210 AF210 -	A260 AF260 -	A300 AF300 -	- AF400 -	- AF460 -	- AF580 -	- AF750 -
Utilization category DC-1, L/R ≤ 1 ms													
	≤110 V	A	-	-	-	-	-	-	-	600	700	800	1050
	≤110 V	A	145	160	250	275	350	400	450	600	700	800	1050
	220 V	A	-	-	-	-	-	-	-	600	700	800	1050
	≤110 V	A	145	160	250	275	350	400	450	600	700	800	1050
	220 V	A	145	160	250	275	350	400	450	600	700	800	1050
	440 V	A	-	-	-	-	-	-	-	600	700	800	1050
	600 V	A	-	-	-	-	-	-	-	600	700	800	1050
Utilization category DC-3, L/R ≤ 2.5 ms													
	≤110 V	A	-	-	-	-	-	-	-	600	700	800	1050
	≤110 V	A	145	160	250	275	350	400	450	600	700	800	1050
	220 V	A	-	-	-	-	-	-	-	600	700	800	1050
	≤110 V	A	145	160	250	275	350	400	450	600	700	800	1050
	220 V	A	145	160	250	275	350	400	450	600	700	800	1050
	440 V	A	-	-	-	-	-	-	-	600	700	800	1050
	600 V	A	-	-	-	-	-	-	-	600	700	800	1050
Utilization category DC-5, L/R ≤ 15 ms													
	≤110 V	A	-	-	-	-	-	-	-	600	700	800	1050
	≤110 V	A	145	160	250	275	350	400	450	600	700	800	1050
	220 V	A	-	-	-	-	-	-	-	600	700	800	1050
	≤110 V	A	145	160	250	275	350	400	450	600	700	800	1050
	220 V	A	145	160	250	275	350	400	450	600	700	800	1050
	440 V	A	-	-	-	-	-	-	-	600	700	800	1050
	600 V	A	-	-	-	-	-	-	-	600	700	800	1050

IEC Technical data

AL9 – AL40

DC circuit switching

General

The arc switching on d.c. is more difficult than on a.c.

- For selecting a contactor it is essential to determine the current, the voltage and the L/R time constant of the controlled load.
- For information, typical time constant values are quoted hereafter: non inductive loads such as resistance furnaces ($L/R \approx 1$ ms), inductive loads such as shunt motors ($L/R \approx 2$ ms) or series motors ($L/R \approx 7.5$ ms).
- The addition of a resistor in parallel with an inductive winding helps in the elimination of the arcs.
- All the poles required for breaking must be connected in series between the load and the source polarity not linked to earth (or chassis).

A.C. operated contactors		AL9	AL12	AL16	AL26	AL30	AL40	
Utilization category DC-1, $L/R \leq 1$ ms								
	≤ 72 V	A	25	27	30	45	55	60
	110 V	A	10	15	20	–	–	–
	220 V	A	–	–	–	–	–	–
	440 V	A	–	–	–	–	–	–
	600 V	A	–	–	–	–	–	–
	≤ 72 V	A	25	27	30	45	55	60
	110 V	A	25	27	30	45	55	60
	220 V	A	10	15	20	–	–	–
	≤ 72 V	A	25	27	30	45	55	60
	110 V	A	25	27	30	45	55	60
	220 V	A	25	27	30	45	55	60
	≤ 72 V	A	25	27	30	45	–	–
	110 V	A	25	27	30	45	–	–
	220 V	A	25	27	30	45	–	–
	440 V	A	10	15	20	–	–	–
Utilization category DC-3, $L/R \leq 2$ ms								
	≤ 72 V	A	25	27	30	45	55	60
	110 V	A	6	7	8	–	–	–
	220 V	A	–	–	–	–	–	–
	440 V	A	–	–	–	–	–	–
	≤ 72 V	A	25	27	30	45	55	60
	110 V	A	25	27	30	45	55	60
	220 V	A	6	7	8	–	–	–
	≤ 72 V	A	25	27	30	45	55	60
	110 V	A	25	27	30	45	55	60
	220 V	A	25	27	30	45	55	60
	≤ 72 V	A	25	27	30	45	–	–
	110 V	A	25	27	30	45	–	–
	220 V	A	25	27	30	45	–	–
	440 V	A	6	7	8	–	–	–
Utilization category DC-5, $L/R \leq 7.5$ ms								
	≤ 72 V	A	9	12	16	25	30	40
	110 V	A	4	4	4	–	–	–
	220 V	A	–	–	–	–	–	–
	440 V	A	–	–	–	–	–	–
	≤ 72 V	A	25	27	30	45	55	60
	110 V	A	10	15	20	30	45	50
	220 V	A	4	4	4	–	–	–
	≤ 72 V	A	25	27	30	45	55	60
	110 V	A	25	27	30	45	55	60
	220 V	A	9	12	16	25	30	40
	≤ 72 V	A	25	27	30	45	–	–
	110 V	A	25	27	30	45	–	–
	220 V	A	10	15	20	30	–	–
	440 V	A	4	4	4	–	–	–

IEC Technical data

EK110 – EK1000

DC circuit switching

General

The arc switching on d.c. is more difficult than on a.c.











- For selecting a contactor it is essential to determine the current, the voltage and the L/R time constant of the controlled load.
- For information, typical time constant values are quoted hereafter: non inductive loads such as resistance furnaces ($L/R \approx 1$ ms), inductive loads such as shunt motors ($L/R \approx 2$ ms) or series motors ($L/R \approx 7.5$ ms).
- The addition of a resistor in parallel with an inductive winding helps in the elimination of the arcs.
- All the poles required for breaking must be connected in series between the load and the source polarity not linked to earth (or chassis).

Technical Data

- The tables indicate for the standard contactors the I_b max. operating currents depending on: the utilization category (i.e. L/R) DC-1, DC-3, DC-5 as defined in the IEC 60947-4-1 publication (see page 1.75 for more details), the operating voltage U_b and the pole coupling details. Ampere values quoted in the tables below are valid for a $-25 \dots +70$ °C temperature close to the contactors, as long as the AC-1 Ampere values (see page 1.61) for the corresponding ambient temperature are not exceeded.
- Max. switching frequency: 300 ops/h.
- For switching higher d.c. ratings, we recommend the use of bar mounted contactors, R series (63 ... 2000 A).

Selection Table

a.c. / d.c. operated contactors

			EK110	EK150	EK175	EK210	EK370	EK550	EK1000
Utilization category DC-1, $L/R \leq 1$ ms									
	≤ 72 V	A	120	145	210	210	370	550	-
	110 V	A	120	145	210	210	370	550	-
	≤ 72 V	A	200	200	300	300	550	800	-
	110 V	A	200	200	300	300	550	800	-
	220 V	A	200	200	300	300	550	800	-
	≤ 72 V	A	200	200	300	300	550	800	-
	110 V	A	200	200	300	300	550	800	-
	220 V	A	200	200	300	300	550	800	-
	440 V	A	-	-	210	210	450	650	-
	600 V	A	-	-	-	-	450	650	-
	≤ 72 V	A	200	200	300	300	550	800	-
	110 V	A	200	200	300	300	550	800	-
	220 V	A	200	200	300	300	550	800	-
	440 V	A	200	200	260	300	450	650	-
	600 V	A	-	-	260	300	450	650	-
Utilization category DC-3, $L/R \leq 2$ ms									
	≤ 72 V	A	120	145	210	210	370	550	-
	110 V	A	135	145	210	210	450	650	-
	≤ 72 V	A	135	135	210	210	450	650	-
	110 V	A	135	135	210	210	450	650	-
	220 V	A	135	135	210	210	450	650	-
	≤ 72 V	A	135	145	210	210	450	650	-
	110 V	A	135	135	210	210	450	650	-
	220 V	A	135	135	210	210	450	650	-
	440 V	A	-	-	210	210	450	650	-
	600 V	A	-	-	-	-	450	650	-
	≤ 72 V	A	135	145	210	210	450	650	-
	110 V	A	135	135	210	210	450	650	-
	220 V	A	135	135	210	210	450	650	-
	440 V	A	135	135	210	210	450	650	-
	600 V	A	-	-	170	210	450	650	-
Utilization category DC-5, $L/R \leq 7.5$ ms									
	≤ 72 V	A	135	145	210	210	450	650	-
	110 V	A	135	135	210	210	450	650	-
	220 V	A	135	135	210	210	450	650	-
	≤ 72 V	A	135	145	210	210	450	650	-
	110 V	A	135	135	210	210	450	650	-
	220 V	A	135	135	210	210	450	650	-
	440 V	A	-	-	210	210	450	650	-
	600 V	A	-	-	-	-	450	650	-
	≤ 72 V	A	135	145	210	210	450	650	-
	110 V	A	135	135	210	210	450	650	-
	220 V	A	135	135	210	210	450	650	-
	440 V	A	135	135	210	210	450	650	-
	600 V	A	-	-	170	210	450	650	-

IEC Technical data

A/AE9 – A/AE/AF/TAE110

Across the line
contactors

1

Main Pole - Utilization Characteristics

Contactor types:	A..., AE...	9	12	16	26	30	40	45	50	63	75	95	110	
	AF..., TAE...	-	-	-	-	-	-	45	50	63	75	95	110	
Rated operational voltage U_e max.	V	690						1000 (690 for AF... contactors)						
Rated frequency limits	Hz	25-400												
Conventional free-air thermal current I_{th} acc. to IEC 60947-4-1, open contactors $\theta \leq 40^\circ\text{C}$	A	26	28	30	45	65	65	100	100	125	125	145	160	
with conductor cross-sectional area mm^2	4	4	4	6	16	16	35	35	50	50	50	70		
Rated operational current I_e / AC-1 for air temperature close to contactor														
U_e max. 690 V	$\left\{ \begin{array}{l} \theta \leq 40^\circ\text{C} \\ \theta \leq 55^\circ\text{C} \\ \theta \leq 70^\circ\text{C} \text{ ③} \end{array} \right.$	A	25	27	30	45	55	60	70	100	115	125	145	160
		A	22	25	27	40	55	60	60	85	95	105	135	145
		A	18	20	23	32	39	42	50	70	80	85	115	130
with conductor cross-sectional area	mm^2	2.5	4	4	6	10	16	25	35	50	50	50	70	
Utilization categorie AC-3														
for air temperature close to contactor $\leq 55^\circ\text{C}$														
Rated operational current I_e AC-3 ①														
220-230-240 V V														
3-phase motors	A	9	12	17	26	33	40	40	53	65	75	96	110	
	A	9	12	17	26	32	37	37	50	65	75	96	110	
	A	9	12	17	26	32	37	37	50	65	72	96	110	
	A	9	12	16	26	32	37	37	45	65	70	93	100	
	A	9	12	14	22	28	33	33	45	55	65	80	100	
	A	7	9	10	17	21	25	25	35	43	46	65	82	
	A	-	-	-	-	-	-	-	23 ②	25 ②	28 ②	30 ②	30 ②	
Rated operational power AC-3 ①														
220-230-240 V kW														
1500 r.p.m. 50 Hz	kW	2.2	3	4	6.5	9	11	11	15	18.5	22	25	30	
1800 r.p.m. 60 Hz	kW	4	5.5	7.5	11	15	18.5	18.5	22	30	37	45	55	
3-phase motors	kW	4	5.5	9	11	15	18.5	18.5	25	37	40	55	59	
	kW	4	5.5	9	15	18.5	22	22	25	37	40	55	59	
	kW	5.5	7.5	9	15	18.5	22	22	30	37	45	55	59	
	kW	5.5	7.5	9	15	18.5	22	22	30	37	40	55	75	
	kW	-	-	-	-	-	-	-	30 ②	33 ②	37 ②	40 ②	40 ②	
Rated making capacity AC-3 according to IEC 60947-4-1														
$10 \times I_e$ AC-3														
Rated breaking capacity AC-3 according to IEC 60947-4-1														
$8 \times I_e$ AC-3														
Short-circuit protection for contactors without thermal O/L relay - Motor protection excluded														
$U_e \leq 500$ V a.c. - gG type fuse	A	25	32	32	50	63	80	100	125	160	160	200		
Rated short-time withstand current I_{cw} at 40°C ambient temp., in free air, from a cold state														
1 s	A	250	280	300	400	600	1000					1320	1320	
10 s	A	100	120	140	210	400	650					800	800	
30 s	A	60	70	80	110	225	370					500	500	
1 min	A	50	55	60	90	150	250					350	350	
15 min	A	26	28	30	45	65	110	110	135	135	160	175		
Maximum breaking capacity														
$\cos \phi = 0.45$ ($\cos \phi = 0.35$ for $I_e > 100$ A)														
at 440 V	A	250			420	820	900	1300				1160		
at 690 V	A	90			170	340	490	630				800		
Heat dissipation per pole														
I_e / AC-1	W	0.8	1	1.2	1.8	2.5	3	2.5	5	6.5	7	6.5	7.5	
I_e / AC-3	W	0.1	0.2	0.35	0.6	0.9	1.3	0.65	1.3	1.5	2	2.7	3.6	
Max. electrical switching frequency														
- for AC-1	cycles/h	600						600 (300 for AF..., AE... TAE...)				300		
- for AC-3	cycles/h	1200 (600 for AE...)						600 (300 for AF..., AE... TAE...)				300		
- for AC-2, AC-4	cycles/h	300						150				150		
Electrical durability														
see pages 1.70 - 1.73														
Mechanical durability														
- millions of operating cycles		10 (5 for AE... and TAE... contactors)												
- max. mechanical switching frequency	cycles/h	3600 (300 for AF... contactors)												



① For the corresponding hp/A values of 1500 r.p.m., 50Hz, 3-phase motors, see page 1.76.



② AF... contactors excluded

③ Unauthorized for TAE... contactors.

IEC Technical data

A/AF145 – AF750

Main Pole - Utilization Characteristics

Contactor types:	A...	145	185	210	260	300	-	-	-	-	
	AF...	145	185	210	260	300	400	460	580	750	
Rated operational voltage U_e max.	V	690									
Rated frequency limits	Hz	25 ... 400									
Conventional free-air thermal current I_{th} acc. to IEC 60947-4-1,											
open contactors $\varnothing \leq 40^\circ\text{C}$	A	250	275	350	400	500	600	700	800	1050	
with conductor cross-sectional area ①	mm ²	120	150	185	240	300 ③	2 x 185	2 x 240	2 x 240	2 x 80 x 5 ②	
Rated operational current I_e / AC-1 for air temperature close to contactor											
U_e max. 690 V	$\varnothing \leq 40^\circ\text{C}$ $\varnothing \leq 55^\circ\text{C}$ $\varnothing \leq 70^\circ\text{C}$	A	250	275	350	400	500	600	700	800	1050
		A	230	250	300	350	400	500	600	700	800
		A	180	180	240	290	325	400	480	580	720
with conductor cross-sectional area	mm ²	120	150	185	240	300 ③	2 x 185	2 x 240	2 x 240	2 x 80 x 5 ②	
Utilization categorie AC-3 for air temperature close to contactor $\leq 55^\circ\text{C}$											
Rated operational current I_e AC-3											
3-phase motors 	220-230-240 V	A	145	185	210	260	305	400	460	580	750
	380-400 V	A	145	185	210	260	305	400	460	580	750
	415 V	A	145	185	210	260	300	400	460	580	750
	440 V	A	145	185	210	240	280	400	460	580	750
	500 V	A	145	170	210	240	280	400	460	580	750
	690 V	A	120	170	210	220	280	350	400	500	650
	1000 V	A	-	-	-	-	-	-	-	-	-
Rated operational power AC-3											
1500 r.p.m. 50 Hz 1800 r.p.m. 60 Hz 3-phase motors 	220-230-240 V	kW	45	55	59	80	90	110	132	160	220
	380-400 V	kW	75	90	110	140	160	200	250	315	400
	415 V	kW	75	90	110	140	160	220	250	355	425
	440 V	kW	75	90	110	140	160	220	250	355	450
	500 V	kW	90	110	132	180	200	250	315	400	520
	690 V	kW	110	132	160	200	250	315	355	500	600
	1000 V	kW	-	-	-	-	-	-	-	-	-
Rated making capacity AC-3 according to IEC 60947-4-1											
		10 x I_e AC-3									
Rated breaking capacity AC-3 according to IEC 60947-4-1											
		8 x I_e AC-3									
Short-circuit protection for contactors without thermal O/L relay - Motor protection excluded											
$U_e \leq 500$ V a.c. - gG type fuse	A	315	355	400	500	630	800	1000			
Rated short-time withstand current I_{cw} at 40°C ambient temp., in free air, from a cold state											
1 s	A	1800	2000	2500	3500	4600	7000				
10 s	A	1200	1500	1700	2400	4400	6400				
30 s	A	800	1000	1200	1500	3100	4500				
1 min	A	600	800	1000	1100	2500	3500				
15 min	A	280	320	400	500	840	1300				
Maximum breaking capacity $\cos \varphi = 0.45$ ($\cos \varphi = 0.35$ for $I_e > 100$ A)											
at 440 V	A	1500	2000	2300	2600	3000	4000	5000	6000	7500	
at 690 V	A	1200	1600	2000	2400	2500	3500	4500	5000	7000	
Heat dissipation per pole											
I_e / AC-1	W	13	16	18	25	32	30	42	32	50	
I_e / AC-3	W	5	8	9	14	18	16	21	17	28	
Max. electrical switching frequency											
- for AC-1	cycles/h	300		300		300		300			
- for AC-3	cycles/h	300		300		300		300			
- for AC-2, AC-4	cycles/h	150		150		60		60			
Electrical durability											
		see pages 1.65 ... 1.69									
Mechanical durability											
- millions of operating cycles		5		3							
- max. mechanical switching frequency	cycles/h	3600 (300 for AF... contactors)				300					

① Conductors with preparation.



② Dimensions of the bars (in mm).

③ For currents above 450A, use terminal extension / enlargement pieces LX 300 / LW 300 see page 1.31).

IEC Technical data

AF1350 – AF1650

Main Pole - Utilization Characteristics

Contactor types: AF..		1350	1650
Rated operational voltage U_e max.	V	1000	1000
Rated frequency limits	Hz	25-400	25-400
Conventional free-air thermal current I_{th} acc. to IEC 60947-4-1, open contactors $\varnothing \leq 40$ °C	A	1350	1650
with conductor cross-sectional area ^①	mm ²	2/100x5	3/100x5
Rated operational current I_e / AC-1 for air temperature close to contactor			
U_e max. 690 V	$\varnothing \leq 40$ °C	A 1350	A 1650
	$\varnothing \leq 55$ °C	A 1150	A 1450
	$\varnothing \leq 70$ °C	A 1000	A 1270
with conductor cross-sectional area	mm ²	2 x 80 x 5 ^①	2 x 80 x 5 ^①
Utilization categorie AC-3			
for air temperature close to contactor ≤ 55 °C			
Rated operational current I_e AC-3			
	220-230-240 V	A 860	A 1050
3-phase motors	380-400 V	A 860	A 1050
	415 V	A 860	A 1050
	440 V	A 860	A 1050
	500 V	A —	A —
	690 V	A —	A —
	1000 V	A —	A —
			
Rated operational power AC-3			
	220-230-240 V	kW 257	kW 315
1500 r.p.m. 50 Hz	380-400 V	kW 475	kW 560
1800 r.p.m. 60 Hz	415 V	kW 500	kW 600
3-phase motors	440 V	kW 560	kW 670
	500 V	kW —	kW —
	690 V	kW —	kW —
	1000 V	kW —	kW —
			
Rated making capacity AC-3 according to IEC 60947-4-1		10 x I_e , AC-3	
Rated breaking capacity AC-3 according to IEC 60947-4-1		8 x I_e , AC-3	
Short-circuit protection for contactors without thermal O/L relay - Motor protection excluded $U_e \leq 500$ V a.c. - gG type fuse		Product coordination with ABB circuit breaker Consult factory	
Rated short-time withstand current I_{cw} at 40 °C ambient temp., in free air, from a cold state			
	1 s	A 10,000	A 12,000
	10 s	A 8000	A 10,000
	30 s	A 6000	A 7500
	1 min	A 4500	A 5500
	15 min	A 1600	A 2200
Maximum breaking capacity $\cos \varphi = 0.45$ ($\cos \varphi = 0.35$ for $I_e > 100$ A)			
	at 440 V	A 10,000	A 12,000
	at 690 V	A —	A —
Max. electrical switching frequency			
– for AC-1	cycles/h	60	60
– for AC-3	cycles/h		
– for AC-2, AC-4	cycles/h		
Electrical durability		50,000	50,000
Mechanical durability			
– millions of operating cycles		500,000	500,000
– max. mechanical switching frequency	cycles/h	60	60

① Dimensions of the bars (in mm).

IEC Technical data

A/AF9 – AF110

Magnet System Characteristics for A... Contactors

Contactor types:	A...	9	12	16	26	30	40	45	50	63	75	95	110	
Rated control circuit voltage U_c														
- at 50 Hz	V	20 ... 690												
- at 60 Hz	V	24 ... 600												
Coil operating limits according to IEC 60947-4-1														
												$\vartheta \leq 55\text{ °C}$	$\vartheta \leq 70\text{ °C}$	
												0.85 ... 1.1 x U_c		0.85 ... 1.1 x U_c
Drop-out voltage in % of U_c														
roughly 40 ... 65 %														
Coil consumption														
Average pull-in value														
50 Hz	VA	70		120		180		350						
60 Hz	VA	80		140		210		450						
50/60 Hz ①	VA/VA	74/70		125/120		190/180		410/365						
Average holding value														
50 Hz	VA/W	8/2		12/3		18/5.5		22/6.5						
60 Hz	VA/W	8/2		12/3		18/5.5		26/8						
50/60 Hz ①	VA/W	8/2		12/3		18/5.5		27/7.5						
Operating time														
between coil energization and:														
- N.O. contact closing	ms	10 ... 26		8 ... 21		8 ... 27		10 ... 25						
- N.C. contact opening	ms	7 ... 21		6 ... 18		7 ... 22		7 ... 22						
between coil de-energization and:														
- N.O. contact opening	ms	4 ... 11		4 ... 11		4 ... 11		7 ... 15						
- N.C. contact closing	ms	9 ... 16		7 ... 14		7 ... 14		10 ... 18						

Magnet System Characteristics for AF... Contactors

Contactor types:	AF..	-	-	-	-	-	-	45	50	63	75	95	110	
Rated control circuit voltage U_c														
- at 50 Hz	V	48 ... 250												
- at 60 Hz	V	48 ... 250												
- d.c.	V	20 ... 250												
Coil operating limits according to IEC 60947-4-1														
												$\vartheta \leq 70\text{ °C}$		
												0.85 ... 1.1 x U_c		
Drop-out voltage in % of U_c														
55 %														
Coil consumption														
Average pull-in value														
50 Hz	VA					210		350						
60 Hz	VA					210		350						
d.c.	W					190		400						
Average holding value														
50 Hz	VA/W					7/2.8		7/3.5						
60 Hz	VA/W					7/2.8		7/3.5						
d.c.	W					2.8		2						
Operating time														
between coil energization and:														
- N.O. contact closing	ms					30 ... 100		30 ... 80						
- N.C. contact opening	ms					27 ... 95		27 ... 77						
between coil de-energization and:														
- N.O. contact opening	ms					30 ... 110		55 ... 125						
- N.C. contact closing	ms					35 ... 115		60 ... 130						

① 50/60 Hz coils: voltage codes 8 0 to 8 8. see page 1.28.

IEC Technical data

A145 – AF750

Across the line
contactors

1

Magnet System Characteristics for A... Contactors

Contactor types:	A...	145	185	210	260	300	-	-	-	-	
Rated control circuit voltage U_c											
- at 50 Hz	V	24 ... 690									
- at 60 Hz	V	24 ... 690									
Coil operating limits according to IEC 60947-4-1		$\sigma \leq 70^\circ\text{C}$ 0.85 ... 1.1 x U_c									
Drop-out voltage in % of U_c		roughly 25 ... 65 %									
Coil consumption											
Average pull-in value	50 Hz	VA	550		1350						
	60 Hz	VA	600		1550						
	50/60 Hz ①	VA/VA	700/650		1700/1550						
Average holding value	50 Hz	VA/W	35/11		60/16						
	60 Hz	VA/W	40/12		65/19						
	50/60 Hz ①	VA/W	44/13		80/21						
Operating time											
between coil energization and:											
- N.O. contact closing	ms		13 ... 27		17 ... 35						
- N.C. contact opening	ms		8 ... 22		12 ... 30						
between coil de-energization and											
- N.O. contact opening	ms		5 ... 10		7 ... 13						
- N.C. contact closing	ms		9 ... 13		10 ... 16						

Magnet System Characteristics for AF... Contactors

Contactor types:	AF...	145	185	210	260	300	400	460	580	750	
Rated control circuit voltage U_c											
- at 50 Hz	V	48 ... 250									
- at 60 Hz	V	48 ... 250									
- d.c.	V	24 ... 250									
Coil operating limits according to IEC 60947-4-1		$\sigma \leq 70^\circ\text{C}$ 0.85 ... 1.1 x U_c									
Drop-out voltage in % of U_c		55 %									
Coil consumption											
Average pull-in value	50 Hz	VA	430		470		890		850		
	60 Hz	VA	430		470		890		850		
	d.c.	W	500		520		990		950		
Average holding value	50 Hz	VA/W	12/3.5		10/2.5		12/4		12/4.5		
	60 Hz	VA/W	12/3.5		10/2.5		12/4		12/4.5		
	d.c.	W	2		2		4		4.5		
Operating time											
between coil energization and:											
- N.O. contact closing	ms		30 ... 115				50 ... 120				
- N.C. contact opening	ms		30 ... 115				50 ... 120				
between coil de-energization and											
- N.O. contact opening	ms		25 ... 80				40 ... 70				
- N.C. contact closing	ms		25 ... 80				40 ... 70				

① 50/60 Hz coils: voltage codes 8 0 to 8 8. see page 1.28.

IEC Technical data

AF1350 – AF1650

Magnet System Characteristics for AF... Contactors

Contactor types: AF...		1350	1650
Rated control circuit voltage U_c			
– at 50 Hz	V	100 - 250	
– at 60 Hz	V	100 - 250	
– d.c.	V	100 - 250	
Coil operating limits according to IEC 60947-4-1		$\vartheta \leq 70\text{ °C}$ 0.85 ... 1.1 x U_c	
Drop-out voltage in % of U_c		55 %	
Coil consumption			
Average pull-in value			
50 Hz	VA	1900	
60 Hz	VA	1900	
d.c.	W	1700	
Average holding value			
50 Hz	VA/W	48/17	
60 Hz	VA/W	48/17	
d.c.	W	16	
Operating time			
between coil energization and:			
– N.O. contact closing	ms	50 - 80	
– N.C. contact opening		ms	50 - 80
between coil de-energization and			
– N.O. contact opening		ms	35 - 55
– N.C. contact closing	ms	35 - 55	
With PLC			
between coil energization and			
– N.O. contact opening		ms	40 - 65
– N.C. contact closing	ms	40 - 65	
between coil de-energization and			
– N.O. contact opening		ms	10 - 30
– N.C. contact closing	ms	10 - 30	

① 50/60 Hz coils: voltage codes 8 0 to 8 8. see page 1.28.

IEC Technical data

AE9 – AE110

TAE45 – TAE110

Across the line
contactors

1

Magnet System Characteristics for AE... Contactors

Contactor types:	AE...	9	12	16	26	30	40	45	50	63	75	95	110
Rated control circuit voltage U_c	V d.c.	12 ... 250											
Coil operating limits according to IEC 60947-4-1		$\varnothing \leq 55^\circ\text{C}$ 0.85 ... 1.1 x U_c										$\varnothing \leq 70^\circ\text{C}$	
Drop-out voltage in % of U_c		roughly 10 ... 30 %						roughly 15 ... 40 %					
Coil consumption - Average values													
- pull-in value	W	90			110			200			400		
- holding value	W	2			2.5			4			2.4		
Coil time constant													
- open	L/R	ms		2		3		3		6			
- closed	L/R	ms		9		16		15		30 ... 40			
Operating time between coil energization and:													
- N.O. contact closing	ms	10 ... 16			13 ... 21			13 ... 30			15 ... 25		
- N.C. contact opening	ms	8 ... 12			11 ... 16			10 ... 27			12 ... 22		
Operating time between coil de-energization and:													
- N.O. contact opening	ms	5 ... 14 ①			6 ... 12 ①			5 ... 15 ①			15 ... 20 ①		
- N.C. contact closing	ms	11 ... 17 ①			8 ... 16 ①			8 ... 18 ①			18 ... 23 ①		

Magnet System Characteristics for TAE... Contactors

Contactor types:	TAE...	-	-	-	-	-	-	45	50	-	75	95	110
Rated control circuit voltage U_c	V d.c.	17 ... 264											
Coil operating limits according to IEC 60947-4-1		$\varnothing \leq 55^\circ\text{C}$ U_c min. ... U_c max.											
Drop-out voltage in % of U_c max.		roughly 20 ... 35 %											
Coil consumption values for U_c min. ... U_c max.													
- pull-in value	W							120 ... 250			300 ... 1000		
- holding value	W							1.7 ... 6.5			2 ... 7		
Coil time constant													
- open	L/R	ms						3		6			
- closed	L/R	ms						15		40			
Operating time between coil energization and:													
- N.O. contact closing	ms							13 ... 30			15 ... 25		
- N.C. contact opening	ms							10 ... 27			12 ... 22		
Operating time between coil de-energization and:													
- N.O. contact opening	ms							5 ... 15 ②			15 ... 20 ②		
- N.C. contact closing	ms							8 ... 18 ②			18 ... 23 ②		

① The use of surge suppressors increases the opening time on a scale of 1.1 to 1.5 for a varistor suppressor and on a scale of 4 to 8 for a diode suppressor. AE 9 ... AE 40 contactors and $U_c \geq 110$ V: table values for contactors with RV 5 surge suppressor (factory mounted).

② The use of surge suppressors increases the opening time on a scale of 1.1 to 1.5 for a varistor suppressor and on a scale of 4 to 8 for a diode suppressor.

IEC Technical data

A9 – A110

Built-in Auxiliary Contacts - Utilization Characteristics

Contactor types: A...		9	12	16	26	30	40	45	50	63	75	95	110
Rated operational voltage U_e max.	V	690						-	-	-	-	-	-
Conventional free air thermal current I_{th} - $\theta \leq 40$ °C	A	16						-	-	-	-	-	-
Rated frequency limits	Hz	25 ... 400					-	-	-	-	-	-	-
Rated operational current I_e / AC-15 according to IEC 60947-5-1													
24-127 V 50/60 Hz	A	6						-	-	-	-	-	-
220-240 V 50/60 Hz	A	4						-	-	-	-	-	-
380-440 V 50/60 Hz	A	3						-	-	-	-	-	-
500 V 50/60 Hz	A	2						-	-	-	-	-	-
690 V 50/60 Hz	A	2						-	-	-	-	-	-
Rated operational current I_e / DC-13 according to IEC 60947-5-1													
24 V d.c.	A / W	6 / 144						-	-	-	-	-	-
48 V d.c.	A / W	2.8 / 134						-	-	-	-	-	-
72 V d.c.	A / W	2 / 144						-	-	-	-	-	-
125 V d.c.	A / W	1.1 / 138						-	-	-	-	-	-
250 V d.c.	A / W	0.55 / 138					-	-	-	-	-	-	-
Rated making capacity acc. to IEC 60947-5-1		10 x I_e / AC-15						-	-	-	-	-	-
Rated breaking capacity acc. to IEC 60947-5-1		10 x I_e / AC-15						-	-	-	-	-	-
Short-circuit protection gG type fuse	A	10						-	-	-	-	-	-
Rated short-time withstand current I_{cw} for 1.0 s	A	100						-	-	-	-	-	-
for 0.1 s	A	140						-	-	-	-	-	-
Minimum switching capacity	V / mA	17 / 5						-	-	-	-	-	-
Non-overlapping time between N.O. and N.C. contacts	ms	≥ 2						-	-	-	-	-	-
Insulating resistance at 500 V d.c. after durability test	MOhm	5						-	-	-	-	-	-
Heat dissipation per pole at 6 A	W	0.10						-	-	-	-	-	-

IEC Technical data

A/AE9 – AF/TAE110

Mounting characteristics

Contactor types:	A..., AE...	9	12	16	26	30	40	45	50	63	75	95	110
	AF..., TAE...	-	-	-	-	-	-	45	50	63	75	95	110
Mounting positions	see "Conditions for use"												
Mounting distances	The contactors can be assembled side by side												
Mounting													
on DIN rail	35 x 7.5 mm						35 x 15 mm						
according to IEC 715 and EN 50022 / EN 50023	35 x 15 mm						75 x 25 mm						75 x 25 mm
by screws (not supplied)	2 x M4						2 x M6						

Conditions for Use

Sustainable utilization conditions for contactors involving at the same time the Mounting position, Ambient temperature and Control voltage operating limits are summarized in the table below.

Contactors	Mounting position	Ambient temperature	Control voltage
A 9 ... A 110, AE 9 ... AE 110	1, 1 ± 30°, 2, 3, 4, 5	≤ 55 °C	0.85 ... 1.1 x U _c
	6	55 ... 70 °C	U _c
AF 45 ... AF 110	1, 1 ± 30°, 2, 3, 4, 5	≤ 55 °C	0.95 ... 1.1 x U _c
	6 unauthorized	> 55 °C unauthorized	-
TAE 45 ... TAE 110	1, 1 ± 30°, 2, 3, 4, 5	≤ 70 °C	0.85 U _c min. ... 1.1 x U _c max.
	6 unauthorized	≤ 55 °C	U _c min. ... U _c max.
		> 55 °C unauthorized	-
	6 unauthorized	-	-

Notes for 4-pole contactors

Whatever the coil voltage: Pos. 5 unauthorized for A 45-22-00, AE 45-22-00, A 75-22-00, AE 75-22-00 contactors.

For 60 Hz coil voltage: (only for devices fitted with CA 5-.. and CAL 5-11 auxiliary contacts or TP timer)

- A 45-40-00, A 50-40-00 and A 75-40-00 contactors

Mounting positions 1 to 5 and ambient temperature ≤ 55 °C: tolerance reduced to 0.9 ... 1.1 U_c (instead of 0.85 ... 1.1 U_c) for coil voltage codes 7 □ and 8 □.

- A 45-22-00 and A 75-22-00 contactors

Mounting positions 1 to 4 (pos. 5 unauthorized) and ambient temperature ≤ 55 °C: tolerance reduced to 0.9 ... 1.1 U_c (instead of 0.85 ... 1.1 U_c) for coil voltage codes 7 □ and 8 □.

For mounting position 6 or ambient temperature of 55 to 70 °C the information given on this page remains applicable.

Mounting Positions (see the above table for authorized positions)

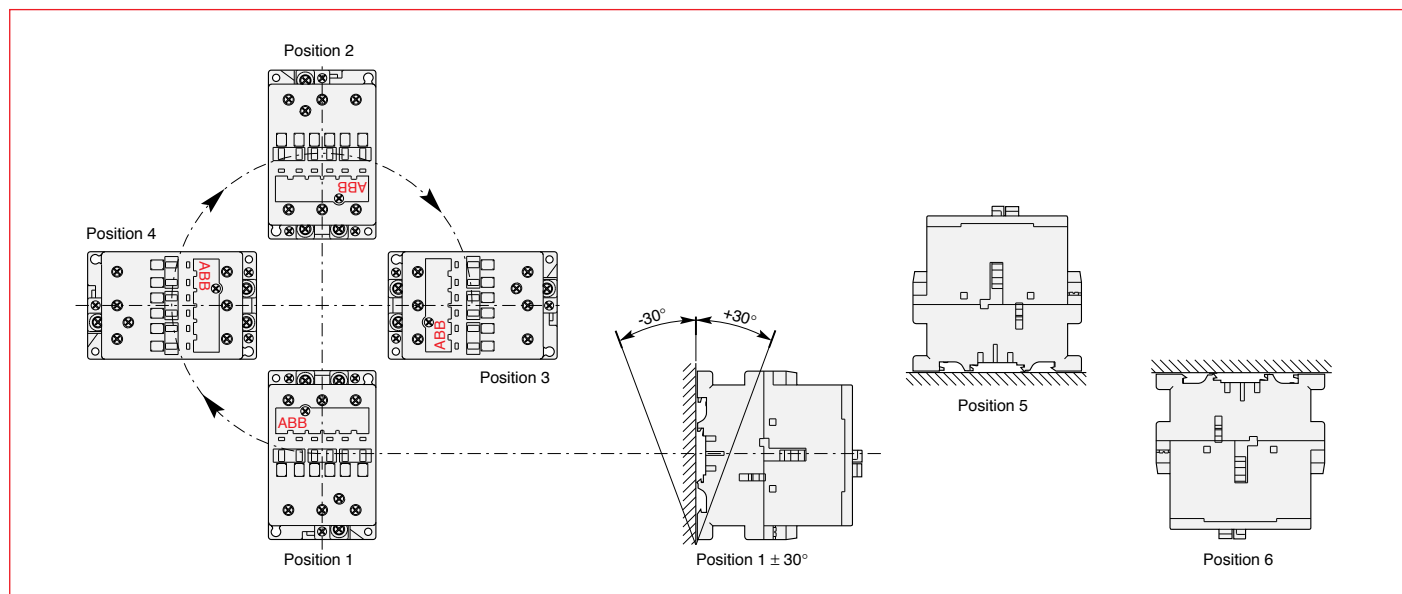

IEC Technical data

A/AF145 – AF1650

Mounting Characteristics – A/AF145 – AF750

Contactor types:	A...	145	185	210	260	300	–	–	–	–
	AF...	145	185	210	260	300	400	460	580	750
Mounting positions	see "Condition for use"									
Mounting distances	The contactors can be assembled side by side									
Fixing										
on DIN rail according to IEC 715 and EN 50022 / EN 50023	– – – – – – – – – –									
by screws (not supplied)	4 x M5								4 x M6	

Mounting Characteristics – AF1350 – AF1650

Contactor types:	AF	1350	1650
Mounting positions	see "Condition for use"		
Mounting distances	The contactors can be assembled side by side		
Fixing			
on DIN rail according to IEC 715 and EN 50022 / EN 50023	– –		
by screws (not supplied)	4 x M8		

Conditions for Use

Sustainable utilization conditions for contactors involving at the same time the Mounting position, Ambient temperature and Control voltage operating limits are summarized in the table below.

Contactors	Mounting position	Ambient temperature	Control voltage
A 145 ... A 300	1, 1 ± 30°, 2, 3, 4, 5	≤ 70 °C	0.85 ... 1.1 x U _c
	6 unauthorized	–	–
AF 145 ... AF 750	1, 1 ± 30°, 2, 3, 4, 5	≤ 70 °C	0.85 x U _c min. ... 1.1 x U _c max.
	6 unauthorized	–	–

Mounting Positions (see the above table for authorized positions)

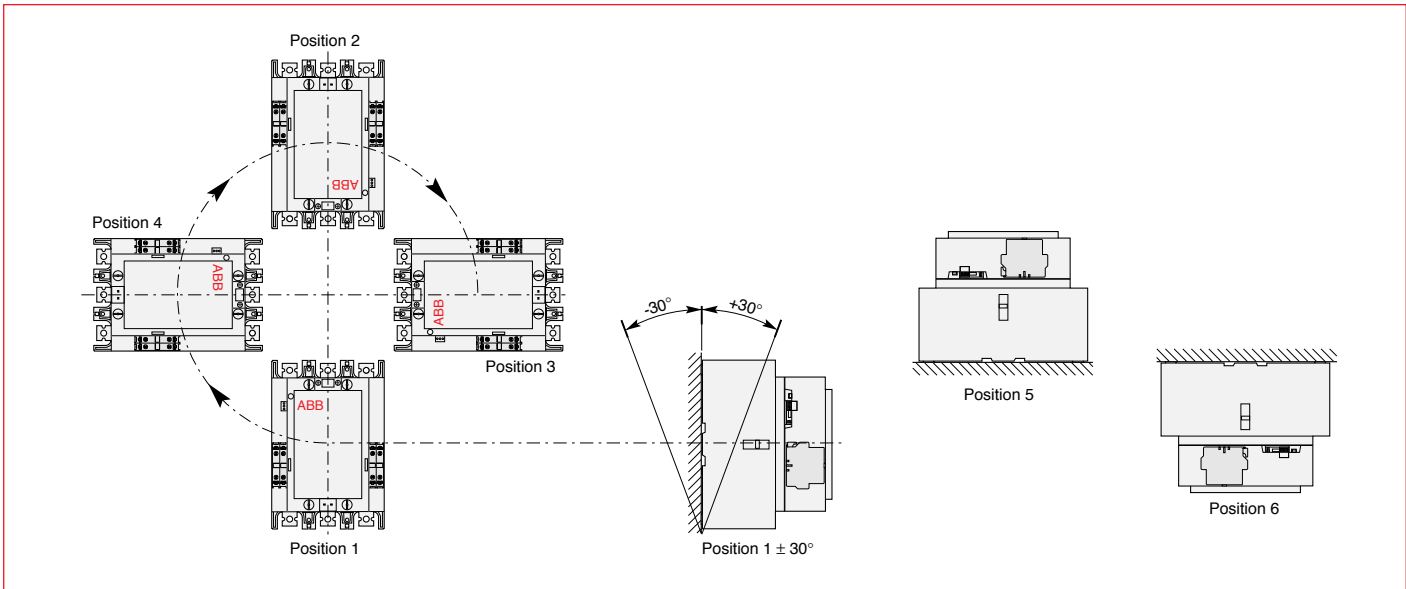

IEC Technical data

A/AE9 – AF/TAE110



Across the line
contactors

1

Connecting Characteristics



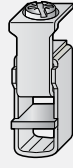

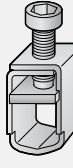





Contactor types:	A..., AE...	9	12	16	26	30	40	45	50	63	75	95	110
	AF..., TAE...	-	-	-	-	-	-	45	50	63	75	95	110

Main terminals

			
with cable clamp	with double connector 2 x (5.6 x 6.5 mm)	with single connector (13 x 10 mm)	with single connector (14 x 14 mm)







Connecting capacity (min. ... max.)

Main conductors (poles)

Rigid: solid ($\leq 4 \text{ mm}^2$)	 1 x mm ²	1 ... 4		1.5 ... 6	2.5 ... 16	6 ... 50		10 ... 95
stranded ($\geq 6 \text{ mm}^2$)	 2 x mm ²	1 ... 4		1.5 ... 6	2.5 ... 16	6 ... 16		6 ... 35
Rigid with connector	 mm ²	-	-	-	-	-	-	-
single for Cu cable	 mm ²	-	-	-	-	-	-	-
single for Al/Cu cable	 mm ²	-	-	-	-	-	-	-
double for Al/Cu cable	 mm ²	-	-	-	-	-	-	-
Flexible with cable end	 1 x mm ²	0.75 ... 2.5		0.75 ... 4	2.5 ... 10	6 ... 35		10 ... 70
	 2 x mm ²	0.75 ... 2.5		0.75 ... 4	2.5 ... 10	6 ... 25		6 ... 35
Bars or lugs	 L mm \leq	8		10	-	-	-	30 [Ⓜ]
	 l mm $>$	3.7		4.2	-	-	-	6

Auxiliary conductors

(built-in auxiliary terminals + coil terminals)

Rigid solid	 1 x mm ²	1 ... 4						0.75 ... 2.5
	 2 x mm ²	1 ... 4						0.75 ... 2.5
Flexible with cable end	 1 x mm ²	0.75 ... 2.5				1 ... 2.5		0.75 ... 2.5
	 2 x mm ²	0.75 ... 2.5						
Lugs	 L mm \leq	8		Ⓜ 8				
	 l mm $>$	3.7		Ⓜ 3.7				

Degree of protection acc. to IEC 60947-1 / EN 60947-1 and IEC 60529 / EN 60529

Protection against direct contact acc. to VDE 0106 - Part. 100

- Main terminals	IP 20					IP 10		
- Coil terminals	IP 20							
- Built-in auxiliary terminals	IP 20							

Screw terminals

(delivered in open position, screws of unused terminals must be tightened)

Main terminals	(+,-) pozidriv 2 screws							hexagon socket
	M3.5		M4	M5		M6		M8 (s = 4 mm)
Coil terminals	M3.5 (+,-) pozidriv 2 screws with cable clamp							
Built-in auxiliary terminals	(+,-) pozidriv 2 screws with cable clamp							
	M3.5		M4	M5				

Tightening torque

Main pole terminals								
- recommended	Nm / lb.in	1.00 / 9		1.7 / 15	2.30 / 20	4.00 / 35		6.00 / 53
- max.	Nm	1.20		2.20	2.60	4.50		6.50
Coil terminals								
- recommended	Nm / lb.in	1.00 / 9						
- max.	Nm	1.20						
Built-in auxiliary terminals								
- recommended	Nm / lb.in	1.00 / 9		1.7 / 15	1.00 / 9			
- max.	Nm	1.20		2.20	1.20			

Terminal marking and positioning

see pages 1.34

Ⓜ $L \leq 8$ and $l > 3.7$ for coil terminal - $L \leq 10$ and $l > 4.2$ for built-in auxiliary terminals.
[Ⓜ] With LW 110 enlargement piece. See page 1.31.

IEC Technical data

A/AF145 – AF750

Connecting Characteristics

Contactor types:	A...	145	185	210	260	300	-	-	-	-
	AF...	145	185	210	260	300	400	460	580	750

Main terminals
Flat type

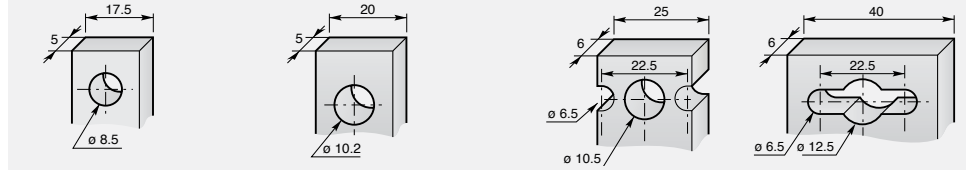

Connecting capacity (min. ... max.)

Main conductors (poles)

Rigid:		1 x mm ²	-	-	-	-	-	-	-	-
		2 x mm ²	-	-	-	-	-	-	-	-
Rigid with connector		mm ²	6 ... 185	16 ... 240		240		300		
single for Cu cable		mm ²	25 ... 150	120 ... 240		240		300		
single for Al/Cu cable		mm ²	-	2 x 95 ... 120		2 x 240		3 x 185		
double for Al/Cu cable		mm ²	-	-		-		-		
Flexible		1 x mm ²	-	-	-	-	-	-	-	-
		2 x mm ²	-	-	-	-	-	-	-	-
Bars or lugs		L mm ≤ Ø mm >	24 8	32 10		47 / 45 10		52 / 50 12		

Auxiliary conductors
(coil terminals)

Rigid solid		1 x mm ²	1 ... 4							
		2 x mm ²	1 ... 4							
Flexible with cable end		1 x mm ²	0.75 ... 2.5							
		2 x mm ²	0.75 ... 2.5							
Lugs		L mm ≤ l mm >	8 3.7							

Degree of protection acc. to IEC 60947-1 /
EN 60947-1 and IEC 60529 / EN 60529

Protection against direct contact acc. to VDE 0106 - part 100

- Main terminals

IP 00

- Coil terminals

IP 20

- Built-in auxiliary terminals

-

Screw terminals

Main terminals

Screws and bolts

M8

M10

M10

M12

Coil terminals (delivered in open position)

M3.5 (+,-) pozidriv 2 screws with cable clamp

Built-in auxiliary terminals

-

-

-

-

-

-

-

-

-

-

-

-

-

-

-

-

Tightening torque

Main pole terminals

- recommended

Nm / lb.in

18 / 160

28 / 240

40 / 354

45 / 443

- max.

Nm

20

30

44

49

Coil terminals

- recommended

Nm / lb.in

1.00 / 9

- max.

Nm

1.20

Built-in auxiliary terminals

- recommended

Nm / lb.in

-

-

-

-

-

-

-

-

-

-

-

-

-

-

-

-

- max.

Nm

-

-

-

-

-

-

-

-

-

-

-

-

-

-

-

-

Terminal marking and positioning

see pages 1.36 & 1.37













IEC Technical data

AF1350 – AF1650

Across the line
contactors

1

Connecting Characteristics

Contactor types:	AF...	1350	1650
Main terminals			
Flat type			
Connecting capacity (min. ... max.)			
Main conductors (poles)			
Rigid:	 1 x mm ²	-	-
	 2 x mm ²	-	-
Rigid with connector			
single for Cu cable	 mm ²	-	-
single for Al/Cu cable	 mm ²	-	-
double for Al/Cu cable	 mm ²	-	-
Flexible	 1 x mm ²	-	-
	 2 x mm ²	-	-
Bars or lugs	 L mm ≤ Ø mm >	100 12	100 12
Auxiliary conductors (coil terminals)			
Rigid solid	 1 x mm ²	1...4	1...4
	 2 x mm ²	1...4	1...4
Flexible with cable end	 1 x mm ²	0.75...2.5	0.75...2.5
	 2 x mm ²	0.75...2.5	0.75...2.5
Lugs	 L mm ≤ l mm >	8 3.7	8 3.7
Degree of protection acc. to IEC 60947-1 / EN 60947-1 and IEC 60529 / EN 60529			
- Main terminals		IP 00	IP 00
- Coil terminals		IP 20	IP 20
- Built-in auxiliary terminals			
Screw terminals		Screw and bolts M12	
Main terminals			
Coil terminals (delivered in open position)		M3.5 (+,-) pozidriv 2 screws with cable clamp	
Built-in auxiliary terminals		-	-
Tightening torque			
Main pole terminals			
- recommended	Nm / lb.in	45/443	45/443
- max.	Nm	49	49
Coil terminals			
- recommended	Nm / lb.in	1.00 / 9	1.00 / 9
- max.	Nm	1.20	1.20
Built-in auxiliary terminals			
- recommended	Nm / lb.in	-	-
- max.	Nm	-	-

UL/CSA & IEC Technical data

AL9 – AL40

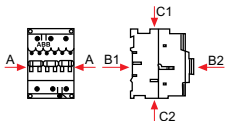

Contactor types:	AL	AL9	AL12	AL16	AL26	AL30	AL40
Rated insulation voltage U_i according to IEC 60947-4-1	V				1000		
according to UL/CSA	V				600		
Rated impulse withstand voltage U_{imp}	kV				8		
Standards		Devices complying with international standards IEC 60947-1 / 60947-4-1 and European standards EN 60947-1 / 60947-4-1					
Air temperature close to contactor – fitted with thermal O/L relay	°C	see "Conditions for use" page 1.50, for control voltage limits and authorized mounting positions					
– without thermal O/L relay	°C	-25 to +55					
– for storage	°C	-40 to +70 (55 max. for TAE... contactors)					
Climatic withstand		-60 to +80					
Climatic withstand		acc. to IEC 60068-2-30 and 60068-2-11 - UTE C 63-100 specification II					
Operating altitude	m	≤ 3000					
Shock withstand acc. IEC 60068-2-27 and EN 60068-2-27 Mounting position 1 (see page 1.50)		1/2 sinusoidal shock for 11 ms: no change in contact position					
		Shock direction	Making position	Breaking position			
		A	20 g	20 g			
		B1	10 g	5 g			
		B2	15 g	15 g			
		C1	20 g	20 g			
		C2	20 g	20 g			



IEC Technical data

AL9 – AL40

Main Pole - Utilization Characteristics

Contactor types:	AL	AL9	AL12	AL16	AL26	AL30	AL40
Rated operational voltage U_o max.	V	690					
Rated frequency limits	Hz	25-400					
Conventional free-air thermal current I_{th} acc. to IEC 60947-4-1, open contactors $\varnothing \leq 40^\circ\text{C}$	A	26	28	30	45	65	65
with conductor cross-sectional area mm^2	4	4	4	6	16	16	35
Rated operational current I_o / AC-1 for air temperature close to contactor							
U_o max. 690 V	$\varnothing \leq 40^\circ\text{C}$	A 25	27	30	45	55	60
	$\varnothing \leq 55^\circ\text{C}$	A 22	25	27	40	55	60
	$\varnothing \leq 70^\circ\text{C}$ ③	A 18	20	23	32	39	42
with conductor cross-sectional area	mm^2	2.5	4	4	6	10	16
Utilization categorie AC-3							
for air temperature close to contactor $\leq 55^\circ\text{C}$							
Rated operational current I_o AC-3 ①							
220-230-240 V	V A	9	12	17	26	33	40
380-400 V	V A	9	12	17	26	32	37
415 V	V A	9	12	17	26	32	37
440 V	V A	9	12	16	26	32	37
500 V	V A	9	12	14	22	28	33
690 V	V A	7	9	10	17	21	25
1000 V	V A	–	–	–	–	–	–
3-phase motors							
							
Rated operational power AC-3 ①							
220-230-240 V	V kW	2.2	3	4	6.5	9	11
380-400 V	V kW	4	5.5	7.5	11	15	18.5
415 V	V kW	4	5.5	9	11	15	18.5
440 V	V kW	4	5.5	9	15	18.5	22
500 V	V kW	5.5	7.5	9	15	18.5	22
690 V	V kW	5.5	7.5	9	15	18.5	22
1000 V	V kW	–	–	–	–	–	–
1500 r.p.m. 50 Hz 1800 r.p.m. 60 Hz 3-phase motors							
							
Rated making capacity AC-3 according to IEC 60947-4-1		$10 \times I_o$ AC-3					
Rated breaking capacity AC-3 according to IEC 60947-4-1		$8 \times I_o$ AC-3					
Short-circuit protection for contactors without thermal O/L relay - Motor protection excluded $U_o \leq 500$ V a.c. - gG type fuse	A	25	32	32	50	63	
Rated short-time withstand current I_{cw} at 40°C ambient temp., in free air, from a cold state							
1 s	A	250	280	300	400	600	
10 s	A	100	120	140	210	400	
30 s	A	60	70	80	110	225	
1 min	A	50	55	60	90	150	
15 min	A	26	28	30	45	65	
Maximum breaking capacity $\cos \varnothing = 0.45$ ($\cos \varnothing = 0.35$ for $I_o > 100$ A)							
at 440 V	A	250	–	–	420	820	
at 690 V	A	90	–	–	170	340	
Heat dissipation per pole							
I_o / AC-1	W	0.8	1	1.2	1.8	2.5	
I_o / AC-3	W	0.1	0.2	0.35	0.6	0.9	
Max. electrical switching frequency							
– for AC-1	cycles/h	600					
– for AC-3	cycles/h	1200					
– for AC-2, AC-4	cycles/h	300					
Mechanical durability							
– millions of operating cycles		10					
– max. mechanical switching frequency	cycles/h	3600					

IEC Technical data

AL9 – AL40, TAL9 - TAL40

Magnet system characteristics for AL contactors

Contactor types:	AL	AL9	AL12	16	26	30	40
Rated control circuit voltage U_c	V d.c. 12 ... 240 (24V & 48V for AL...Z)						
Coil operating limits according to IEC 60947-4-1	$\vartheta \leq 55^\circ\text{C}$ 0.85 ... 1.1 x U_c						
Drop-out voltage in % of U_c	roughly 15 ... 30 %						
Coil consumption - Average values							
- pull-in value	W	3 (2.4 for AL9Z - AL16Z)			3.5		
- holding value	W	3 (2.4 for AL9Z - AL16Z)			3.5		
Coil time constant							
- open	L/R	ms	40				
- closed	L/R	ms	90				
Operating time							
between coil energization and:							
- N.O. contact closing		ms	50 ... 75				
- N.C. contact opening		ms	45 ... 70				
between coil de-energization and							
- N.O. contact opening		ms	15 ... 30				
- N.C. contact closing		ms	17 ... 32				

Magnet System Characteristics for TAL... Contactors

Contactor types:	TAL	TAL9	TAL12	TAL16	TAL26	TAL30	TAL40
Rated control circuit voltage U_c	V d.c. 9 ... 264						
Coil operating limits according to IEC 60947-4-1	$\vartheta \leq 55^\circ\text{C}$ 0.85 ... 1.1 x U_c						
Drop-out voltage in % of U_c max.	roughly 20... 35 %						
Coil consumption values for U_c max. and 20 °C							
- U_c max. DC	W	8.5			9		
- U_c min. DC	W	2.5			2.7		
- U_c DC	W	5			5.4		
Operating time							
between coil energization and:							
- N.O. contact closing		ms	50 ... 100		55 ... 110		
- N.C. contact opening		ms	20 ... 70		25 ... 75		
between coil de-energization and							
- N.O. contact opening		ms	10 ... 17 ①		12 ... 18 ①		
- N.C. contact closing		ms	16 ... 27 ①		18 ... 28 ①		

① The use of surge suppressors increases the opening time on a scale of 1.1 to 1.5 for a varistor suppressor and on a scale of 4 to 8 for a diode suppressor.

IEC Technical data

AL9 – AL40

Across the line
contactors

1

Built-in Auxiliary Contacts - Utilization Characteristics

Contactor types: AL	AL9	AL12	AL16	AL26	AL30	AL40
Rated operational voltage U_o max. V	690					
Conventional free air thermal current I_{th} - $\theta \leq 40$ °C A	16					
Rated frequency limits Hz	25 ... 400					
Rated operational current I_o / AC-15 according to IEC 60947-5-1						
24-127 V 50/60 Hz A	6					
220-240 V 50/60 Hz A	4					
380-440 V 50/60 Hz A	3					
500 V 50/60 Hz A	2					
690 V 50/60 Hz A	2					
Rated operational current I_o / DC-13 according to IEC 60947-5-1						
24 V d.c. A / W	6 / 144					
48 V d.c. A / W	2.8 / 134					
72 V d.c. A / W	2 / 144					
125 V d.c. A / W	1.1 / 138					
250 V d.c. A / W	0.55 / 138					
Rated making capacity acc. to IEC 60947-5-1	10 x I_o / AC-15					
Rated breaking capacity acc. to IEC 60947-5-1	10 x I_o / AC-15					
Short-circuit protection gG type fuse A	10					
Rated short-time withstand current I_{cw}						
for 1.0 s A	100					
for 0.1 s A	140					
Minimum switching capacity V / mA	17 / 5					
Non-overlapping time between N.O. and N.C. contacts ms	≥ 2					
Insulating resistance at 500 V d.c. after durability test MOhm	5					
Heat dissipation per pole at 6 A W	0.10					

IEC Technical data

AL9 – AL40

Mounting characteristics

Contactor types:	AL	AL9	AL12	AL16	AL26	AL30	AL40
Mounting positions		see "Conditions for use"					
Mounting distances		The contactors can be assembled side by side					
Mounting							
on DIN rail		35 x 7.5 mm					
according to IEC 715 and EN 50022 / EN 50023		35 x 15 mm					
by screws (not supplied)		2 x M4					

Conditions for Use

Sustainable utilization conditions for contactors involving at the same time the Mounting position, Ambient temperature and Control voltage operating limits are summarized in the table below.

Contactors	Mounting position	Ambient temperature	Control voltage
AL9 – AL40	1, 1 ± 30°, 2, 3, 4, 5	≤ 55 °C	0.85 ... 1.1 x U _c
	6 (Unauthorized)	55 ... 70 °C	U _c

Mounting Positions (see the above table for authorized positions)

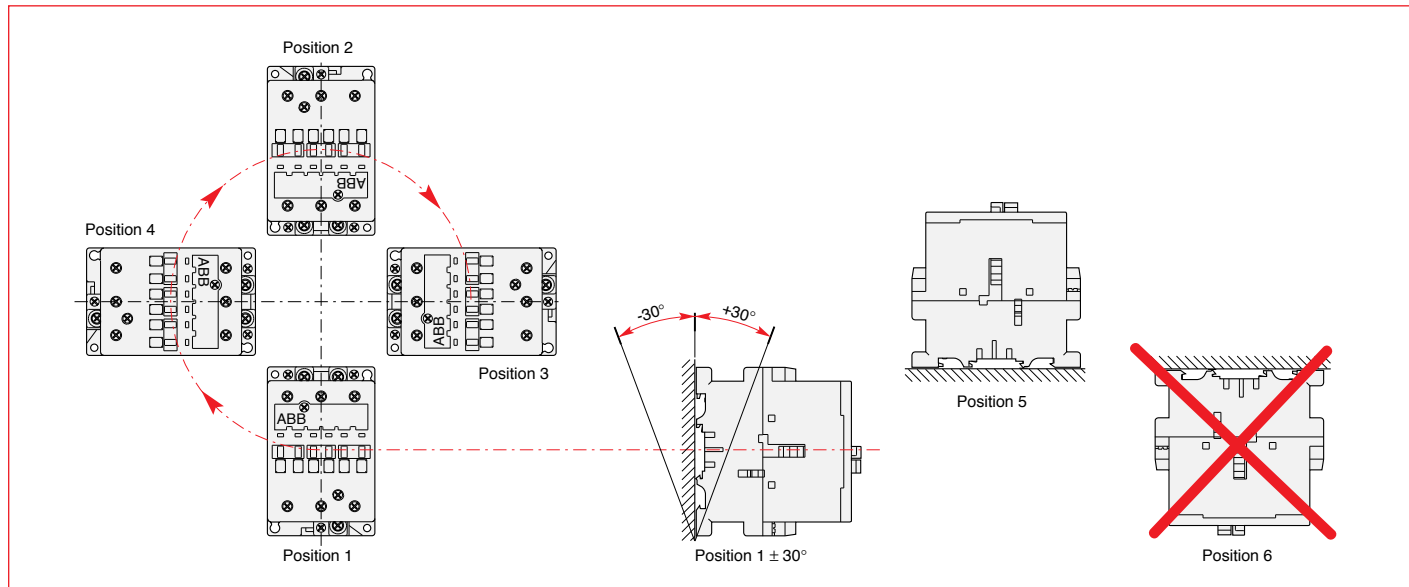

IEC Technical data

AL9 – AL40

Across the line
1

Connecting Characteristics

Contactor types: **AL** **AL9** **AL12** **AL16** **AL26** **AL30** **AL40**

Main terminals



Connecting capacity (min. ... max.)

Main conductors (poles)

Rigid: solid ($\leq 4 \text{ mm}^2$)		1 x mm ²	1 ... 4		1.5 ... 6	2.5 ... 16
		2 x mm ²	1 ... 4		1.5 ... 6	2.5 ... 16
Rigid with connector		mm ²	-	-	-	-
single for Cu cable		mm ²	-	-	-	-
single for Al/Cu cable		mm ²	-	-	-	-
double for Al/Cu cable		mm ²	-	-	-	-
Flexible with cable end		1 x mm ²	0.75 ... 2.5		0.75 ... 4	2.5 ... 10
		2 x mm ²	0.75 ... 2.5		0.75 ... 4	2.5 ... 10
Bars or lugs		L mm \leq	8		10	-
		l mm $>$	3.7		4.2	-

Auxiliary conductors

(built-in auxiliary terminals + coil terminals)

Rigid solid		1 x mm ²	1 ... 4			
		2 x mm ²	1 ... 4			
Flexible with cable end		1 x mm ²	0.75 ... 2.5			
		2 x mm ²	0.75 ... 2.5			
Lugs		L mm \leq	8		① 8	
		l mm $>$	3.7		① 3.7	

Degree of protection acc. to IEC 60947-1 / EN 60947-1 and IEC 60529 / EN 60529

Protection against direct contact acc. to VDE 0106 - Part. 100

- Main terminals IP 20
- Coil terminals IP 20
- Built-in auxiliary terminals IP 20

Screw terminals

(delivered in open position, screws of unused terminals must be tightened)

Main terminals		(+,-) pozidriv 2 screws			
		M3.5		M4	M5
Coil terminals		M3.5 (+,-) pozidriv 2 screws with cable clamp			
Built-in auxiliary terminals		(+,-) pozidriv 2 screws with cable clamp			
		M3.5		M4	M5

Tightening torque

Main pole terminals					
- recommended	Nm / lb.in	1.00 / 9		1.7 / 15	2.30 / 20
- max.	Nm	1.20		2.20	2.60
Coil terminals					
- recommended	Nm / lb.in	1.00 / 9			
- max.	Nm	1.20			
Built-in auxiliary terminals					
- recommended	Nm / lb.in	1.00 / 9		1.7 / 15	1.00 / 9
- max.	Nm	1.20		2.20	1.20

Terminal marking and positioning see pages 1.35

① $L \leq 8$ and $l > 3.7$ for coil terminal - $L \leq 10$ and $l > 4.2$ for built-in auxiliary terminals.

② With LW 110 enlargement piece. See page 1.31.

IEC Technical data

EK110 – EK1000

General Technical Data

Contactor types: EK...		110	150	175	210	370	550	1000
Rated insulation voltage U_i according to IEC 60947-4-1	V	1000						
according to UL/CSA	V	600						
Rated impulse withstand voltage U_{imp}	kV	8						
Standards		Devices complying with international standards IEC 60947-1 / 60947-4-1 and European standards EN 60947-1 / 60947-4-1						
Air temperature close to contactor – fitted with thermal O/L relay	°C	see "Conditions for use" page 1.63, for control voltage limits and authorized mounting positions						
– without thermal O/L relay	°C	-25 to +55						
– for storage	°C	-40 to +70						
Climatic withstand		acc. to IEC 60068-2-30						
Operating altitude	m	≤ 3000						
Shock withstand acc. IEC 60068-2-27 and EN 60068-2-27		1/2 sinusoidal shock for 15 ms: no change in contact position						
Mounting position 1 (see page 1.63)		Contactor in making or breaking position						
		Shock direction: A, C1, C2: 10 g						
		B1: 10 g						
		B2: 10 g						

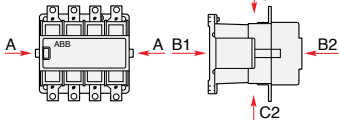



IEC Technical data

EK110 – EK1000

Across the line
contactors

1

Main Pole - Utilization Characteristics

Contactor types:	EK...	110	150	175	210	370	550	1000	
Rated operational voltage U_o max.	V	1000						690	
Rated frequency limits	Hz	25 ... 400							
Conventional free-air thermal current I_{th} acc. to IEC 60947-4-1, open contactors $\theta \leq 40^\circ\text{C}$	A	200	250	300	350	550	800	1000	
with conductor cross-sectional area	mm ²	95	150	185	240	2 x 185	2 x 240	2 x 300	
Rated operational current I_o / AC-1 for air temperature close to contactor									
U_o max. 690 V	$\theta \leq 40^\circ\text{C}$	A	200	250	300	350	550	800	1000
	$\theta \leq 55^\circ\text{C}$	A	180	230	270	310	470	650	800
	$\theta \leq 70^\circ\text{C}$	A	155	200	215	250	400	575	720
with conductor cross-sectional area	mm ²	95	150	185	240	2 x 185	2 x 240	2 x 300	
Utilization categorie AC-3									
for air temperature close to contactor $\leq 55^\circ\text{C}$									
Rated operational current I_o AC-3									
3-phase motors 	220-230-240 V	A	120	145	210	400	550	–	
	380-400 V	A	120	145	210	400	550	–	
	415 V	A	120	145	210	400	550	–	
	440 V	A	120	145	210	370	550	–	
	500 V	A	120	145	210	370	550	–	
	690 V	A	120	120	210	370	550	–	
	1000 V	A	64	80	113	155	175	–	
Rated operational power AC-3									
1500 r.p.m. 50 Hz	220-230-240 V	kW	30	45	59	110	160	–	
1800 r.p.m. 60 Hz	380-400 V	kW	55	75	110	200	280	–	
3-phase motors 	415 V	kW	55	75	110	220	315	–	
	440 V	kW	59	75	110	220	315	–	
	500 V	kW	75	90	132	250	400	–	
	690 V	kW	110	110	160	355	500	–	
	1000 V	kW	90	110	160	220	250	–	
Rated making capacity AC-3 according to IEC 60947-4-1									
			$10 \times I_o$ AC-3					–	
Rated breaking capacity AC-3 according to IEC 60947-4-1									
			$8 \times I_o$ AC-3					–	
Short-circuit protection for contactors without thermal O/L relay - Motor protection excluded									
$U_o \leq 500$ V a.c. - gG type fuse	A	250		355		630	800	1000	
Rated short-time withstand current I_{cw} at 40°C ambient temp., in free air, from a cold state									
1 s	A	1700	1800	2300		5500		6800	
10 s	A	900	1200	1680		5300		6400	
30 s	A	600	700	1000		3700		4400	
1 min	A	450	550	800		3000		3400	
15 min	A	210	250	320		1000		1200	
Maximum breaking capacity									
$\cos \phi = 0.45$ ($\cos \phi = 0.35$ for $I_o > 100$ A)									
at 440 V	A	1400	1500	2000		5000	5400	–	
at 690 V	A	1100	1200	1700		5000	5400	–	
Heat dissipation per pole									
I_o / AC-1	W	10	13	18		40	60	80	
I_o / AC-3	W	3	5	9		15	25	–	
Max. electrical switching frequency									
– for AC-1	cycles/h	300						300	
– for AC-3	cycles/h	300						–	
– for AC-2, AC-4	cycles/h	150		120				–	
Electrical durability									
		see pages 1.75							
Mechanical durability									
– millions of operating cycles		10				5			
– max. mechanical switching frequency	cycles/h	3600				3600			

IEC Technical data

EK110 – EK1000

Magnet System Characteristics for EK... Contactors - a.c. Operated

Contactor types:	EK...	110	150	175	210	370	550	1000
Rated control circuit voltage U_c								
- at 50 Hz	V	24 ... 500				48 ... 500		
- at 60 Hz	V	24 ... 600				110 ... 600		
Coil operating limits according to IEC 60947-4-1		$\vartheta \leq 70^\circ\text{C}$ 0.85 ... 1.1 x U_c						
Drop-out voltage in % of U_c		roughly 45 ... 65 %						
Coil consumption								
Average pull-in value	50 Hz ^① VA	800		1100		3500		
	60 Hz ^① VA	900		1200		4000		
	50/60 Hz ^② VA/VA	500/500		630/630		3800/3400		
Average holding value	50 Hz ^① VA/W	44/15		52/18		125/50		
	60 Hz ^① VA/W	52/18		65/22		140/60		
	50/60 Hz ^② VA/W	2.5/2.5		2.5/2.5		140/60		
Operating time								
between coil energization and:								
- N.O. contact closing	ms	20 ... 40 ^① / 30 ... 50 ^②				30 ... 60		
- N.C. contact opening	ms	15 ... 35 ^① / 25 ... 45 ^②				25 ... 55		
between coil de-energization and:								
- N.O. contact opening	ms	7.5 ... 15 ^① / 95 ... 120 ^②				10 ... 20		
- N.C. contact closing	ms	10 ... 18 ^① / 100 ... 125 ^②				13 ... 23		

Magnet System Characteristics for EK... Contactors - d.c. Operated

Contactor types:	EK...	110	150	175	210	370	550	1000
Rated control circuit voltage U_c	V d.c.	12 ... 220				24 ... 220		
Coil operating limits according to IEC 60947-4-1		$\vartheta \leq 70^\circ\text{C}$ 0.85 ... 1.1 x U_c						
Drop-out voltage in % of U_c		roughly 15 ... 50 %						
Coil consumption - Average values								
- pull-in value	W	500		630		1100		
- holding value	W	2.5		2.5		20		
Coil time constant								
- open	L/R	ms	8			12		
- closed	L/R	ms	50			60		
Operating time								
between coil energization and:								
- N.O. contact closing	ms	30 ... 50				60 ... 80		
- N.C. contact opening	ms	27 ... 47				55 ... 75		
between coil de-energization and:								
- N.O. contact opening	ms	10 ... 35						
- N.C. contact closing	ms	13 ... 38						

① "A" coil voltage codes see page 1.29.

② 50/60 Hz "E" coil voltage codes see page 1.29.

IEC Technical data

EK110 – EK1000

Across the line
contactors

1

Mounting Characteristics

Contactor types:	EK...	110	150	175	210	370	550	1000
Mounting positions	see "Conditions for use"							
Fixing by screws (supplied)	4 x M6					4 x M6 (1)		

Conditions for Use

Sustainable utilization conditions for contactors involving at the same time the Mounting position, Ambient temperature and Control voltage operating limits are summarized in the table below.

Contactors	Mounting position	Ambient temperature	Control voltage
E110 ... EK210	1, $1 \pm 30^\circ$, 3, 4, 5 2, 6 unauthorized	$\leq 70^\circ\text{C}$	$0.85 \dots 1.1 \times U_c$
E370 ... EK1000	1, $1 \pm 30^\circ$, 2, 3, 4, 5 6 unauthorized	$\leq 70^\circ\text{C}$	$0.85 \dots 1.1 \times U_c$

Mounting Positions (see the above table for authorized positions)

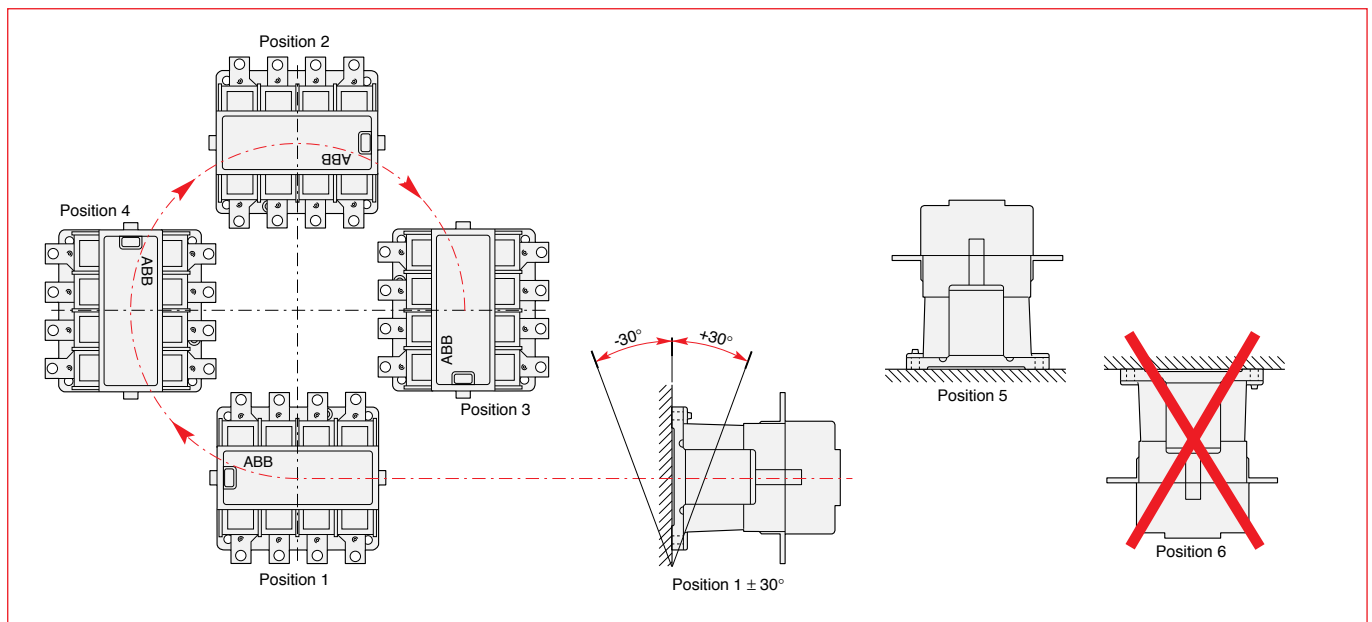

① Damping elements are supplied

IEC Technical data

EK110 – EK1000

Connecting Characteristics

Contactor types: EK...

		110	150	175	210	370	550	1000
Main terminals Flat type								
Connecting capacity (min. ... max.)								
Main conductors (poles)								
Rigid:								
1 x mm ²		-	-	-	-	-	-	-
2 x mm ²		-	-	-	-	-	-	-
Rigid with connector								
single for Cu cable mm ²	25 ... 120	25 ... 185		70 ... 300				
single for Al/Cu cable mm ²		10 ... 70	35 ... 120			70 ... 300		95 ... 300
double for Al/Cu cable mm ²						2 x 35 ... 185		2 x 95 ... 300
Flexible								
1 x mm ²		-	-	-	-	-	-	-
2 x mm ²		-	-	-	-	-	-	-
Bars or lugs								
L mm ≤		30	30	33		55		
Ø mm >		6	10	10		10		
Auxiliary conductors (coil terminals)								
Rigid solid								
1 x mm ²		0.5 ... 2.5						
2 x mm ²		0.5 ... 2.5						
Flexible with cable end								
1 x mm ²		0.5 ... 2.5						
2 x mm ²		0.5 ... 2.5						
Lugs								
L mm ≤		8						
l mm >		3.7						
Degree of protection acc. to IEC 60947-1 / EN 60947-1 and IEC 60529 / EN 60529		Protection against direct contact acc. to VDE 0106 - Part. 100						
- Main terminals		IP 00						
- Coil terminals		IP 20						
Screw terminals		Screws and bolts						
Main terminals		M6 M10						
Coil terminals (delivered in open position)		M3.5 (+,-) pozidriv 2 screws with cable clamp						
Tightening torque								
Main pole terminals								
- recommended Nm / lb.in		5 / 44	18 / 160					
- max. Nm		6	22					
Coil terminals								
- recommended Nm / lb.in		1.00 / 9						
- max. Nm		1.20						

IEC Technical data

Contactor electrical durability and Utilization categories

General

Utilization categories determine the current making and breaking conditions relating to the characteristics of the loads to be controlled by the contactors. International standard IEC 60947-4-1 and European standard EN 60947-4-1 are the standards to be referred to.

If I_c is the current to be broken by the contactor and I_o the rated operational current normally drawn by the load, then:

- Categories AC-1 and AC-3: $I_c = I_o$
- Category AC-2: $I_c = 2.5 \times I_o$
- Category AC-4: $I_c = 6 \times I_o$

Generally speaking $I_c = m \times I_o$ where m is a multiple of the load operational current.

On pages 1.66 - 1.71, the curves corresponding to categories AC-1, AC-2, AC-3 and AC-4 represent the electrical durability variation of standard contactors in relation to the breaking current I_c .

Electrical durability is expressed in millions of operating cycles.

These curves have been plotted for 400 V - 50 Hz 3-phase currents but remain valid up to 690 V - 40 ... 60 Hz provided that a check is carried out to make sure that at the operational voltage U_o , the current I_o normally drawn by the load does not exceed the value of the contactor rated operational current: I_o / AC-1 for category AC-1 and I_o / AC-3 for categories AC-3 and AC-4. The values are given for each type of contactor in pages 1.44, 1.45, 1.54, and 1.61 (Technical Data).

Curve Utilization Mode

Electrical durability forecast and contactor selection for categories AC-1, AC-2, AC-3 or AC-4

- Note the characteristics of the load to be controlled:
 - Operational voltage U_o
 - Current normally drawn I_o (U_o / I_o / kW relation for motors, + page 0/0).
 - Utilization category AC-1, AC-2, AC-3 or AC-4
 - Breaking current $I_c = I_o$ for AC-1 and for AC-3 ; $I_c = 2.5 \times I_o$ for AC-2 ; $I_c = 6 \times I_o$ for AC-4
- Define the number of operating cycles N required.
- On the diagram corresponding to the operational category, select the contactor with the curve immediately above the intersection point (I_c ; N).

Electrical durability forecast and contactor selection for mixed duty motor control: AC-3 ($I_c = I_o$) type switching off while "motor running" and, occasionally, AC-4 ($I_c = 6 \times I_o$) type switching off while "motor accelerating".

- Note the characteristics of the motor to be controlled:
 - Operational voltage U_o
 - Current normally drawn while "motor running" I_o (U_o / I_o / kW relation for motors, + 0/0).
 - Breaking current for AC-3 $I_c = I_o$
 - Breaking current for AC-4 while "motor accelerating" $I_c = 6 \times I_o$
 - Percentage of AC-4 operations K (on the basis of the total number of operating cycles)
- Define the total number of operating cycles N required.
- Note the smallest contactor rating compatible for AC-3 (U_o / I_o) on pages 2/62, 2/63, 2/73, and 2/79.
- For the selected contactor make a note of the following in relation to the voltage using diagram AC-3 page 2/85 and AC-4 page 2/86 or 2/87:
 - The number of operating cycles A for $I_c = I_o$ (AC-3)
 - The number of operating cycles B for $I_c = 6 \times I_o$ (AC-4)
- Calculate the estimated number of cycles N' (N' is always below A)

$$N' = \frac{A}{1 + 0.01 K (A/B - 1)}$$

- If N' is too low in relation to the target N , calculate the estimated number of cycles for a higher contactor rating.

Case of uninterrupted duty.

Among the different utilization categories, the uninterrupted duty implies the following remark. The combined effect of environmental conditions and the proper temperature of the product may require some disposals. As a matter of fact, for this duty, the use duration prevails over the number of operating cycles.

For long term service, some verifications of preventing maintenance are needed to check the functionality of the concerned product (consult us).

Over a duration of five years, in these conditions the contactor might present high internal resistance. We recommend to change the contactor or change the contacts.

IEC Technical data

A9 – AF750

Electrical durability

Electrical Durability for AC-1 Utilization Category. Ambient Temperature $\leq 55\text{ }^{\circ}\text{C}$

Switching non-inductive or slightly inductive loads. The breaking current I_c for AC-1 is equal to the rated operational current of the load.

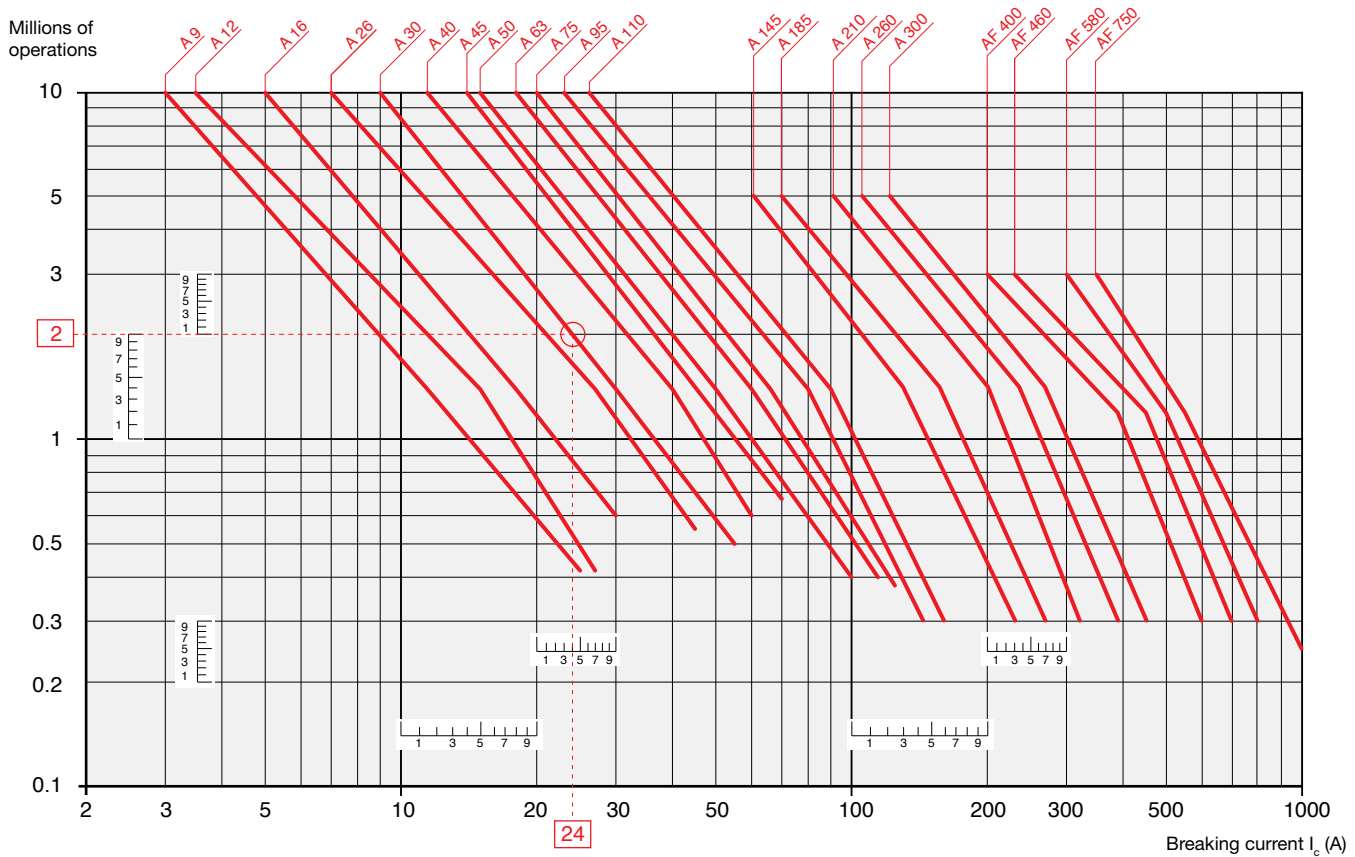

Example:

$I_c / \text{AC-1} = 24\text{ A}$ – Electrical durability required = 2 million operations.

Using the AC-1 curves above select the A 30 contactor at intersection "O" (24 A / 2 million operations).

IEC Technical data

A9 – AF750

Electrical durability

Switching cage motors: starting and switching off running motors. The breaking current I_c for AC-3 is equal to the rated operational current I_o (I_o = motor full load current).

Electrical Durability for AC-3 Utilization Category - $U_e \leq 440$ V. Ambient Temperature ≤ 55 °C

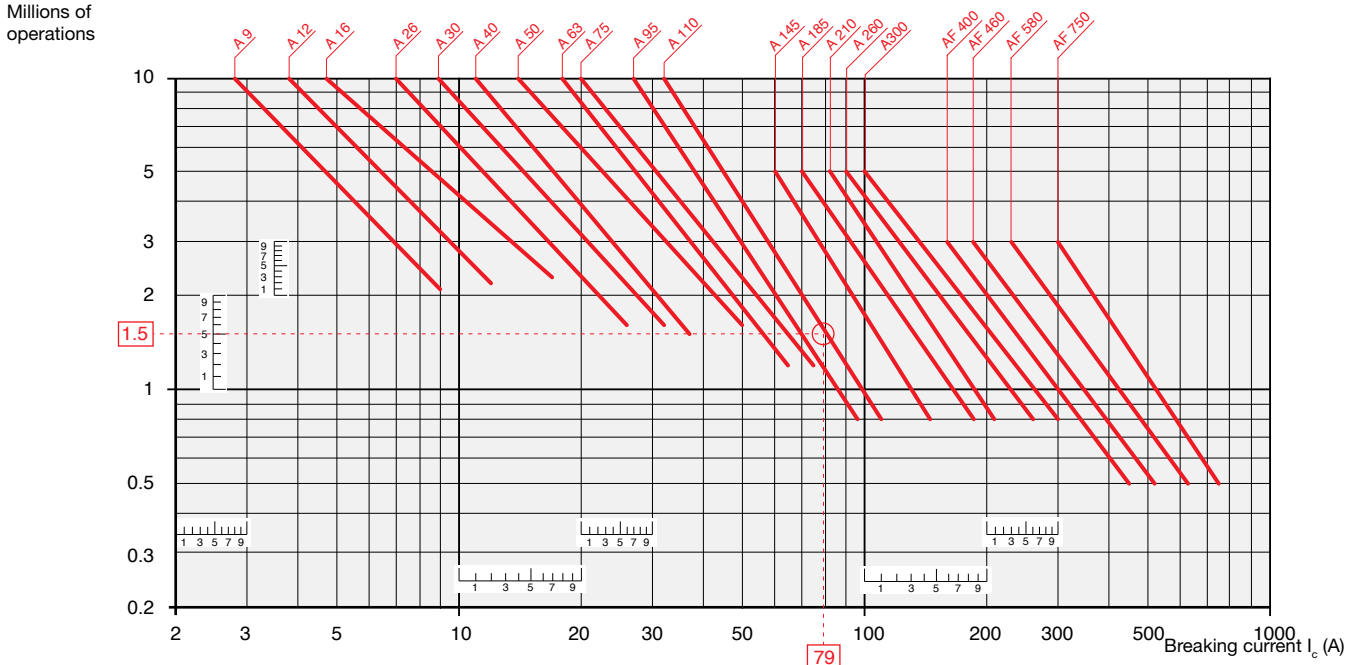

Electrical Durability for AC-3 Utilization Category - 440 V < $U_e \leq 690$ V. Ambient Temperature ≤ 55 °C

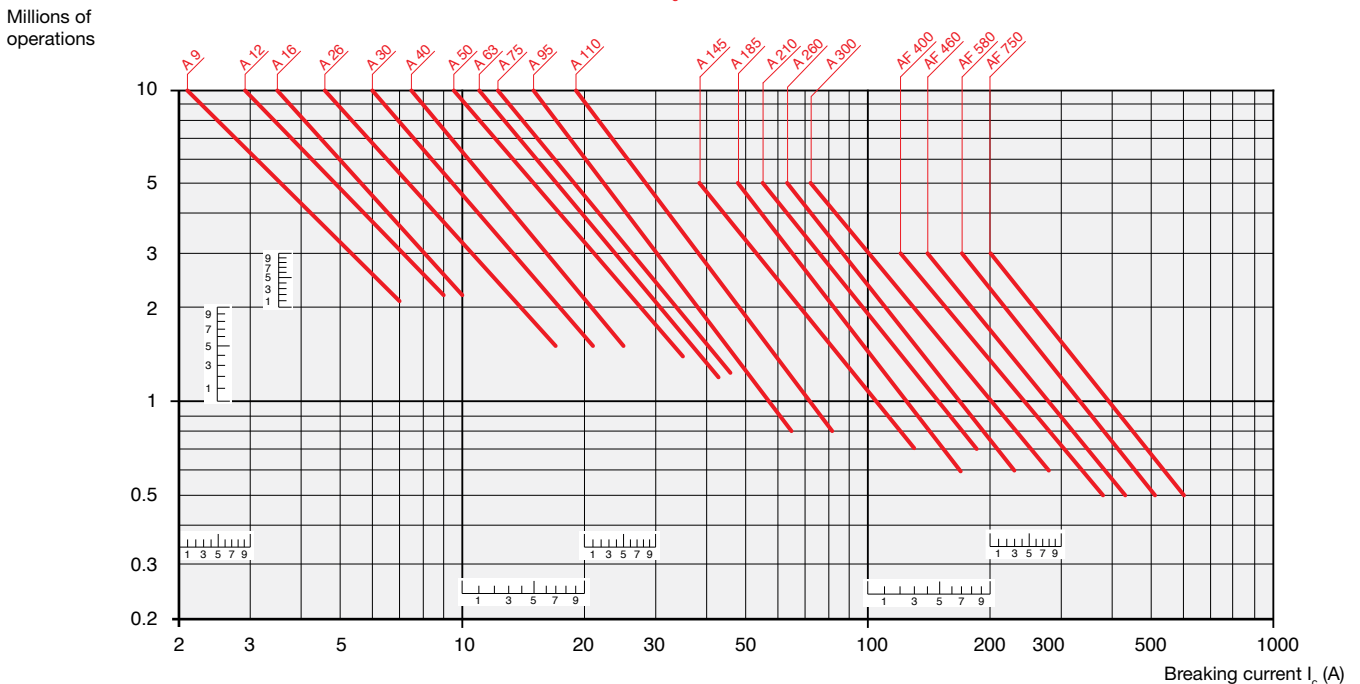

Example:

Motor power 40 kW for AC-3 - $U_e = 400$ V utilization – Electrical durability required = 1.5 million operations.

40 kW, 400 V corresponds to $I_o = 79$ A. For AC-3: $I_c = I_o$. Select the A 110 contactor at intersection "O" (79 A / 1.5 million operations) on the curves (AC-3 - $U_e \leq 440$ V).

IEC Technical data

A9 – AF750

Electrical durability

Electrical Durability for AC-2 or AC-4 Utilization Category - $U_e \leq 440$ V. Ambient Temperature ≤ 55 °C

Maximum number of AC-2 or AC-4 operations: 300 per hour for A 9 ... A 40 contactors,
150 per hour for A 50 ... A 300 contactors.

Switching cage motors: starting, reverse operation and step-by-step operation. The breaking current I_c is equal to $2.5 \times I_e$ for AC-2 and $6 \times I_e$ for AC-4, keeping in mind that I_e is the motor rated operational current (I_e = motor full-load current).

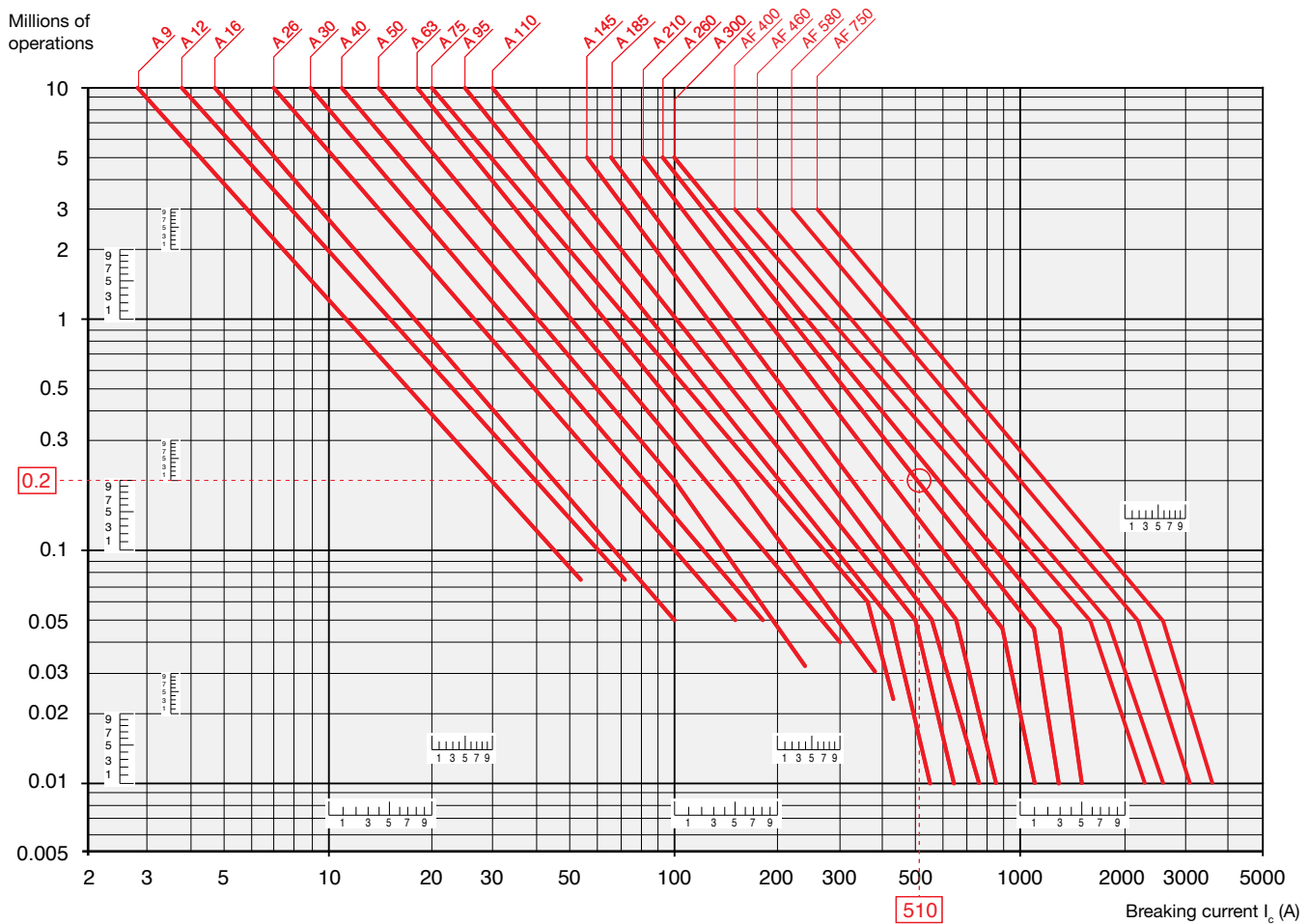

Example:

Motor power 45 kW for AC-4 - $U_e = 400$ V utilization - Electrical durability required = 0.2 million operations.
45 kW, 400 V corresponds to $I_e = 85$ A.

For AC-4: $I_c = 6 \times I_e = 510$ A - Select the A 260 contactor at intersection "O" (510 A / 0.2 million operations) on the curves (AC-4 - $U_e \leq 440$ V).

IEC Technical data

A9 – AF750

Electrical durability

Across the line
contactors

1

Electrical Durability for AC-2 or AC-4 Utilization Category - $440\text{ V} < U_e \leq 690\text{ V}$. Ambient Temperature $\leq 55\text{ }^\circ\text{C}$

Maximum number of AC-2 or AC-4 operations: 300 per hour for A 9 ... A 40 contactors,
150 per hour for A 50 ... A 300 contactors.

Switching cage motors: starting, reverse operation and step-by-step operation. The breaking current I_c is equal to $2.5 \times I_e$ for AC-2 and $6 \times I_e$ for AC-4, keeping in mind that I_e is the motor rated operational current (I_e = motor full-load current).

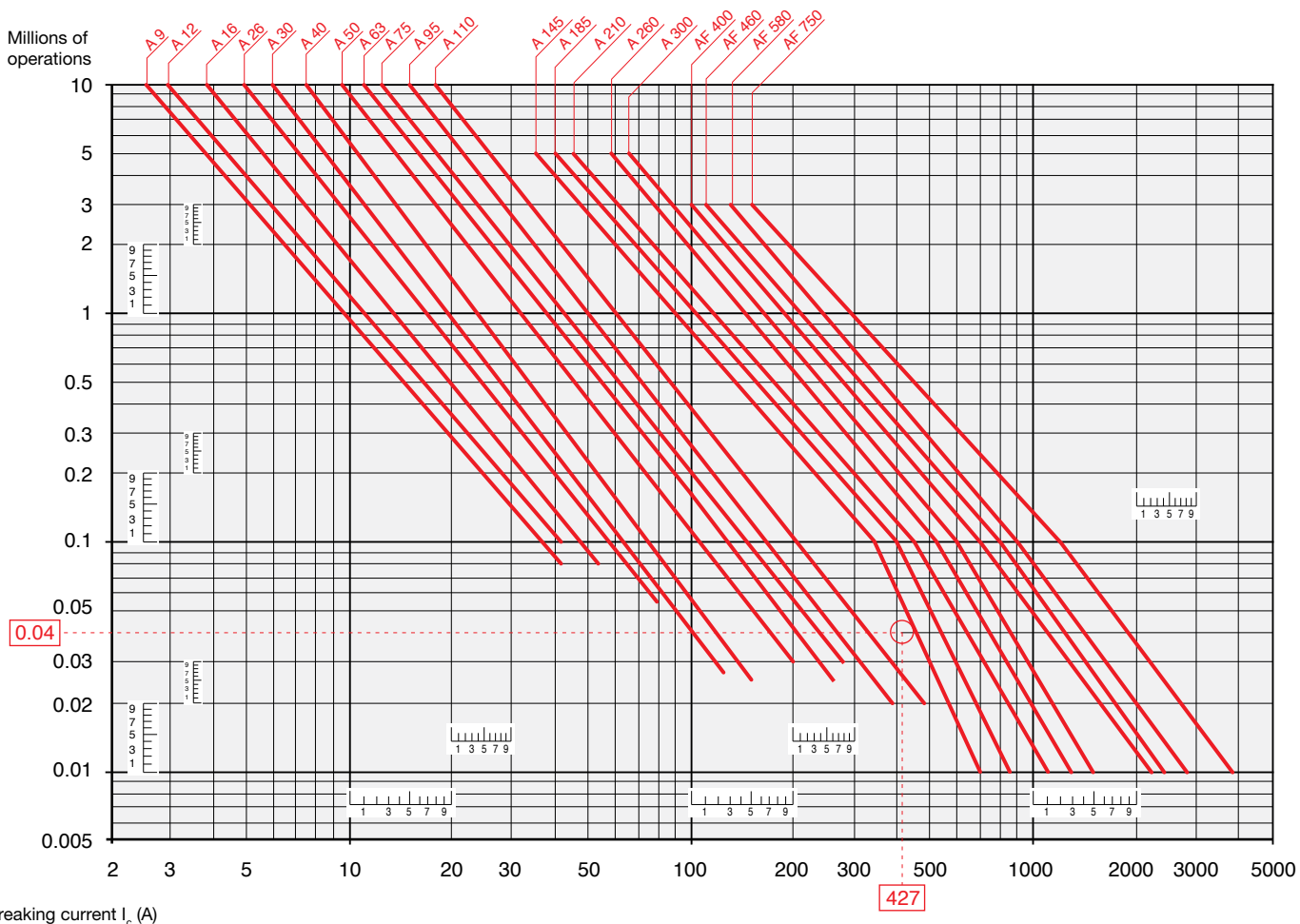

Example:

Motor power 59 kW for AC-4 - $U_e = 600\text{ V}$ utilization – Electrical durability required = 0.04 million operations.

As stated on page 0/0: 59 kW, 600 V corresponds to $I_e = 71.1\text{ A}$.

For AC-4: $I_c = 6 \times I_e = 426.6\text{ A}$ - Select the A 145 contactor at intersection "O" (427 A / 0.04 million operations) on the curves (AC-4 - $440\text{ V} < U_e \leq 690\text{ V}$).

IEC Technical data
AL9 – AL40
Electrical durability

Consult
factory

IEC Technical data

EK110 – EK1000

Electrical durability

Across the line
contactors

1

Electrical Durability for AC-1 Utilization Category. Ambient Temperature $\leq 55\text{ }^{\circ}\text{C}$

Switching non-inductive or slightly inductive loads. The breaking current I_c for AC-1 is equal to the rated operational current of the load.

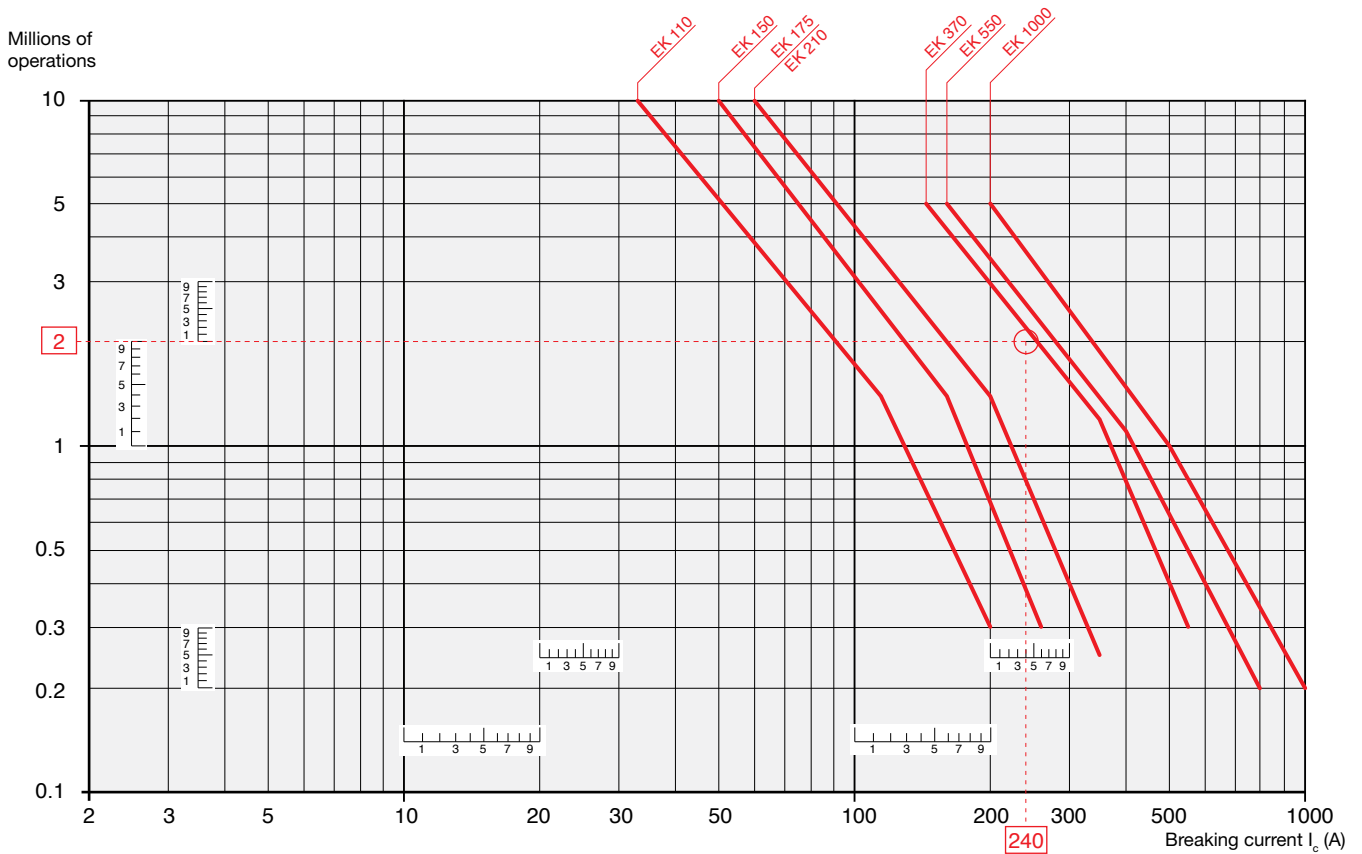

Example:

$I_c / \text{AC-1} = 240\text{ A}$ – Electrical durability required = 2 million operations.

Using the AC-1 curves above select the EK 370 contactor at intersection "O" (240 A / 2 million operations).

IEC Technical data

Influence of the length of conductors used in contactor control circuits



A 50-30-00



AF 460-30-11

Under certain conditions the excessive length of the control circuit conductors may prevent the contactor from carrying out closing and opening orders.

- no closing: due to excessive voltage drop (in a.c. or d.c.).
- no opening: due to excessive capacitance (in a.c.).

Contactor Closing (contactor with a.c. or d.c. fed control circuit)

The voltage drop is due to the pull-in current (pull-in power) and to the resistance of the control circuit conductors.

The table and graph below can be used to determine the single length of line feeders (distance between the control device and the contactor coil) in relation to:

- I the coil pull-in consumption.
- I the supply voltage.
- I the connecting wire cross-sectional area.

The graph has been drawn for a max. line voltage drop of 5 %.

Coil pull-in consumption (average value)

Contactors	a.c. control circuit 50 Hz	Contactors	d.c. control circuit
A 9, 12, 16	70 VA	AE 9, 12, 16	90 W
A 26, 30, 40	120 VA	AE 26, 30, 40	110 W
A 45, 50, 63, 75	180 VA	AE 45, 50, 63, 75	200 W
A 95, 110	450 VA	AE 95, 110	400 W
A 145, 185	700 VA	BC 9, 16, 18, 25, 30	7 W
A 210, 260, 300	1700 VA		
AF 45, 50, 63, 75	210 VA	AF 45, 50, 63, 75	190 W
AF 95, 110	350 VA	AF 95, 110	400 W
AF 145, 185	430 VA	AF 145, 185	500 W
AF 210, 260, 300	470 VA	AF 210, 260, 300	520 W
AF 400, 460	890 VA	AF 400, 460	990 W
AF 580, 750	850 VA	AF 580, 750	950 W

Permissible single length for the control circuit conductors on contactor closing:

Depending on the coil pull-in power consumption on the supply voltage and on the control circuit conductor cross-sectional area.

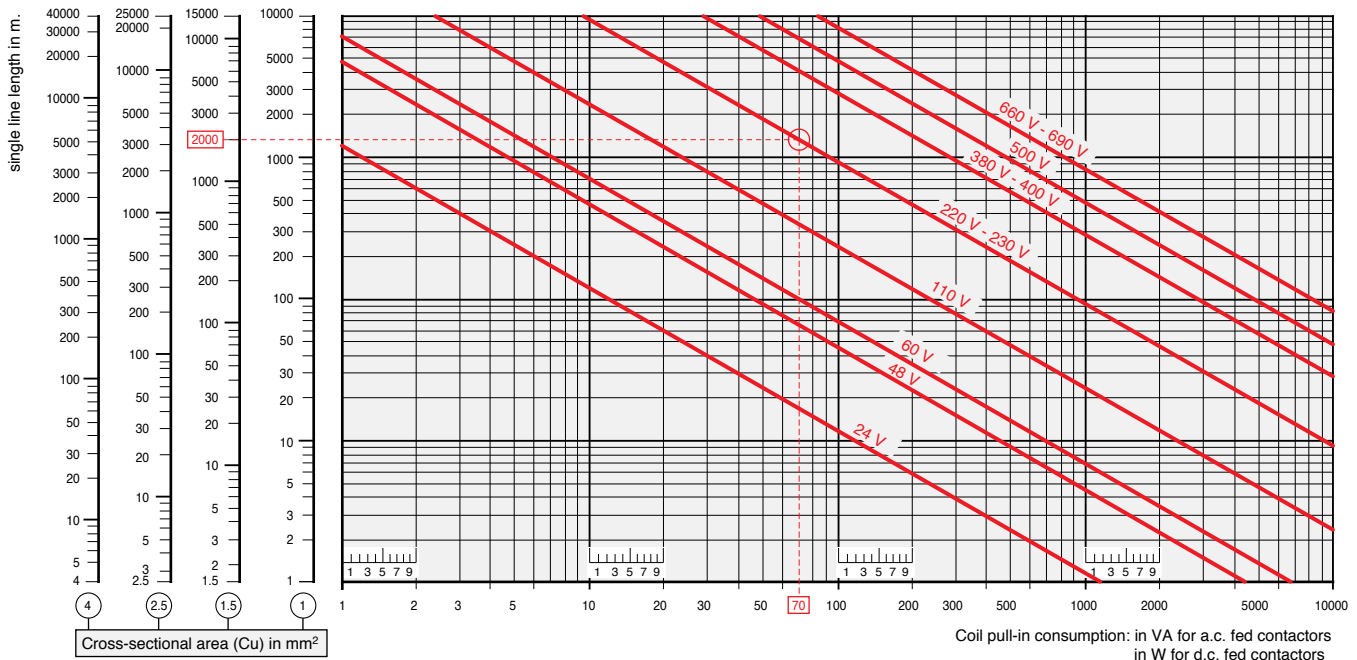

Example:

A 9 contactor

Coil voltage: 230 V 50 Hz, contactor coil pull-in power consumption: 70 VA, control circuit conductor cross-sectional area: Cu 1.5 mm².

Max. permissible length: 2000 m.

IEC Technical data

Influence of the length of conductors used in contactor control circuits

Single control line length

Wiring diagram A
Via maintained pushbutton and 2-core cable (with a capacity of 0.2 µF/km, for example).

Single control line length

Wiring diagram B
Via momentary pushbutton plus hold-in contact and 3-core cable (with a capacity of 2 x 0.2 = 0.4 µF/km, for example).

Contactor Opening (contactor with a.c. fed control circuit)

Under certain conditions, an a.c. operated contactor does not open when the control circuit is de-energized.

This is due to a critical capacity of the excessively long control circuit line and the type of contactor coil control layout (see diagrams A and B opposite).

This may be caused by the following factors:

- high control voltage.
- low coil holding consumption.
- low contactor drop-out voltage (according to IEC 60947-4-1: 0.2 to 0.75 x U_c).

If lines longer than those indicated are required, the following measures must be taken:

- select a contactor with a higher rating.
- select a lower control voltage.
- connect "R_p" impedances in parallel with the contactor coil:

$$\text{sizing of parallel resistor: } R_p = \frac{10^3}{C} \quad (\text{with } C \text{ in } \mu\text{F})$$

The table and graph below can be used to determine the single length of line feeders (distance between the control device and the contactor coil) in relation to:

- the coil holding consumption VA.
- the supply voltage.
- the capacity in µF/km (depending on the control layout).

Wiring diagrams A and B opposite show two supply and coil control wiring examples.

Coil holding consumption (average value)

Contactors	a.c. control circuit 50 Hz	Contactors	a.c. control circuit 50 Hz
A 9, 12, 16	8 VA	AF 45, 50, 63, 75	7 VA
A 26, 30, 40	12 VA	AF 95, 110,	7 VA
A 45, 50, 63, 75	18 VA	AF 145, 185,	12 VA
A 95, 110	22 VA	AF 210, 260, 300	10 VA
A 145, 185	35 VA	AF 400, 460	12 VA
A 210, 260, 300	60 VA	AF 580, 750	12 VA

Permissible single length for the control circuit conductors on contactor opening:

Depending on the coil holding power consumption, on the supply voltage and on the control circuit conductor capacity.

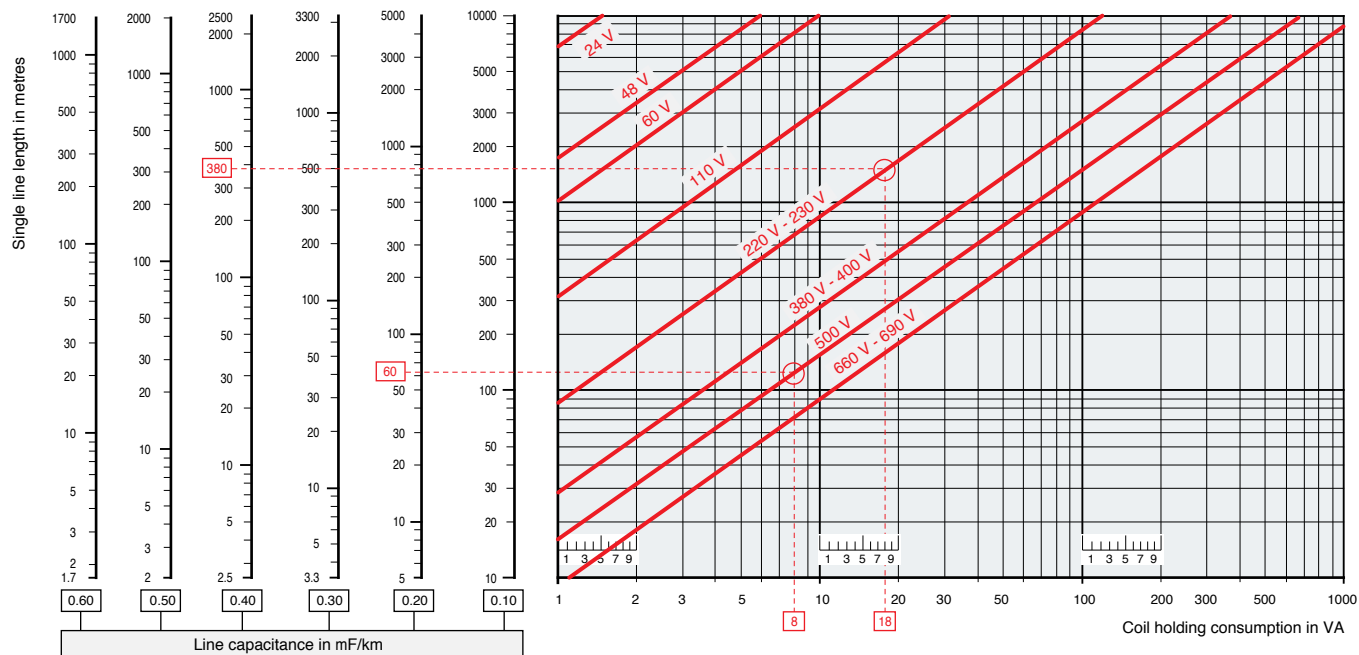

Examples:

A 16 contactor

Coil voltage U_c = 500 V, 50 Hz, 8 VA contactor coil holding consumption, control type: diagram A, via maintained pushbutton, and 2-core cable with a capacity of 0.2 µF/km.

Max. permissible length: 60 m.

A 50 contactor

Coil voltage U_c = 230 V, 50 Hz, 18 VA contactor coil holding consumption, control type: diagram B via momentary pushbutton, hold-in contact and 3-core cable with a capacity of 2 x 0.2 µF/km = 0.4 µF/km.

Max. permissible length: 380 m.

IEC Technical data

Parallel connection of main poles

Parallel Connection of Main Poles

Purpose: Increasing the a.c. resistive load.

Remarks:

- Parallel connection of main poles to increase the d.c. resistive load is not acceptable.
- Parallel connection of main poles doesn't increase the breaking capacity.

Means: The poles can be connected in parallel via shorting bars. See page 1.30.

- LP and LH for parallel connection of 2 poles,
- LY and LF for parallel connection of 3 poles,

The table below shows the uprating factor for $I_g / AC-1$ max. in relation to the number of poles in parallel and for a max. switching frequency.

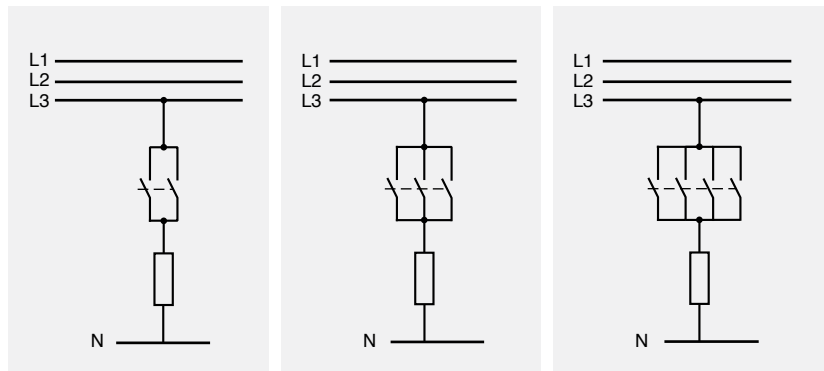

2 poles in //

3 poles in //

4 poles in //

Contactors			Factor to be applied to the rated operational current $I_g / AC-1$ to obtain the permissible current $I_g / AC-1$ with "n" poles in parallel.				
a.c. Operated	d.c. Operated	Cycles / h					
3-pole contactors							
A 9 ... A 75	AF 50 ... AF 75						
AF 50 ... AF 75	AE..., TAE...	600	1.6	2.2			
	AL...	A 95 ... A 300	AF 145 ... AF 750	300	1.6	2.2	-
AF 145 ... AF 750							
4-pole contactors							
A 9 ... A 75	AF 45 ... AF 75						
AF 45 ... AF 75	AE..., TAE...	600	1.6	2.2	2.6		
	AL...	EK...	EK...	300	1.6	2.2	2.8

IEC Technical data

Temporary or intermittent duty

Across the line
contactors

1

Utilization of Contactors for Temporary / Intermittent Duty

The table below shows the factor to be applied to the rated operational current $I_o / AC-1$ to obtain the permissible operational current $I_o / AC-1$ in relation to the switching frequency and the current flow time per cycle.

Operating cycles per hour	120	60	20	6	2	1
Current flow time per cycle in seconds.	Factor to be applied to the rated operational current $I_o / AC-1$ max. to obtain the permissible current $I_o / AC-1$ for temporary / intermittent duty.					
5	2.8	3.4	4	4.7	5	5.2
10	2.2	2.6	3	3.4	3.7	3.8
20	1.6	2	2.4	2.6	2.7	2.8
30	–	1.7	2.1	2.2	2.3	2.4
40	–	1.5	1.9	2.0	2.1	2.2
60	–	–	1.7	1.8	1.8	1.9

Example:

A 9 contactor (intermittent duty, resistive load)

Rated operational current $I_o / AC-1$ at 55 °C (see page 1.42)

22 A

Switching frequency

2 operations/h

Current flow time per cycle

20 s

Factor to be applied to the current $I_o / AC-1$

2.7

Permissible current: $2.7 \times 22 =$

59 A

Technical data

Technical terms and definitions

Altitude

Refers to the height of the site where the equipment is located, expressed in meters above the sea level.

Ambient temperature

Temperature of the air surrounding the unit.

Circuits

• Auxiliary circuit

All the conducting parts of a contactor, intended to be included in a circuit different from the main circuit and the control circuit of the contactor e.g. signalization, interlocking circuits etc ...

• Control circuit

All the conducting parts of a contactor (other than the main circuit) included in a circuit used for the closing operation, or opening operation, or both, of the contactor.

• Main circuit

All the conducting parts of a contactor included in the circuit which it is designed to close or open.

Coil operating range

Expressed as a multiple of the rated control circuit voltage U_c for the lower and upper limits.

Cycle duration

Total time of the on-load + off-load period.

Endurance / durability

• Electrical endurance

Number of on-load operating cycles (i.e. with current on the main contacts) a contactor can achieve, varies depending on the utilization category.

• Mechanical endurance

Number of off-load operating cycles (i.e. without current on the main contacts) a contactor can achieve.

Inching

Energizing a motor once or repeatedly for short periods to obtain small movements of the driven mechanism.

Insulation class according to the VDE 0110 and NFC 20-040

Characterizes contactors suitability in accordance with environment and utilization conditions. A contactor can be classified depending on its own clearance and creepage distances in the insulation classes A, B, C, D which correspond to different insulation voltage values.

The insulation class C is applicable to most of the industrial applications. Equipment described in this catalogue correspond to insulation class C.

Intermittent duty

Duty in which the main contacts of a contactor remain closed for periods of time insufficient to allow the contactor to reach thermal equilibrium, the current-carrying periods being separated by off-load periods of sufficient duration to restore equality of temperature with the cooling medium.

Mounting positions

Stated by the manufacturer. Please note restrictions when applicable.

On-load factor

Ratio of the current flow time to the total time of the cycle x 100.

Plugging

Stopping or reversing a motor quickly by interchanging two supply leads whilst the motor is running.

Rated breaking capacity; Rated making capacity

Value of r.m.s current a contactor can break or make at a fixed voltage value, within the conditions specified by the standards, depending on the utilization category.

Rated control circuit voltage U_c

Control voltage value for which the control circuit of the unit is sized.

Rated insulation voltage U_i

Voltage value which designates the unit and to which dielectric tests, clearance and creepage distances are referred.

Rated impulse withstand voltage U_{imp}

The highest peak value of an impulse voltage of prescribed form 1.2/50, which does not cause breakdown under specified conditions of test.

Rated operating current I_e

Current value stated by the manufacturer and taking into account the rated operating voltage U_e , the rated frequency, the rated duty, the utilization category, the electrical contact life and the type of the protective enclosure.

Rated operating voltage U_e

Voltage value to which utilization characteristics of the contactor are referred, i.e. phase to phase voltage in 3 phase circuits.

Conventional thermal current I_{th}

Value of current the contactor can withstand with poles in closed position, in free air for an eight hour duty, without the temperature rise of its various parts exceeding the limits specified by the standards.

Resistance to shocks

Requirements applicable for instance to vehicles, crane operation or switchgear slide-in module systems.

At the quoted permissible «g» values, contactors must not undergo a change in switching state and O/L relays must not trip.

Resistance to vibrations

Requirements applicable to all the vehicles, vessels and other similar transport systems. At the quoted amplitude and vibration frequency values, the unit must be capable to achieve the required duty.

Short-circuit protection coordination

Achieved by using back-up protection devices such as circuit-breakers, H.R.C. fuses or standard fuses.

Co-ordination types a, b, c are defined in IEC 292-1 publication, VDE 0660, NFC 63-650 standards. Co-ordination types "1" and "2" are defined in IEC 947-4-1.

• Type 1 co-ordination

There has been no discharge of parts beyond the enclosure. Damage to the contactor and the overload relay is acceptable.

• Type 2 co-ordination

No damage to the overload relay or other parts has occurred, except that welding of contactor or starter contacts is permitted, if they are easily separated.

Switching frequency

Number of operating cycles per hour.

Time

• Closing time

Time between energization of the coil until the moment the contacts of the first current path to be closed actually close.

• Opening time

Time from the beginning of state causing breaking until the moment when the contacts of the last current path to be opened are open.

• Minimal operation time

Shortest control duration to ensure complete closing or opening of a contactor.

• Short time current permissible

Value of current which the contactor can withstand in closed position for a short time period and within specified conditions.

• Time constant

Ratio of inductance to the resistance : $L/R = \text{mH}/\text{Ohm} = \text{ms}$.

IEC Technical data

Standards, utilization categories

Standards

- IEC standards 158-1: "Contactors" and series IEC 292 :

"Motor-starters" have been revised and replaced by the new IEC 947-4-1 (1990-05): "Contactors and Motor-starters" referring to IEC 947-1 (1988): "General rules" The new standards will constitute the basis of the future European and National standards, not yet revised.

Therefore the ratings indicated in this catalog are established according to the former and the future standards.

- Main changes and additions in the new standards are:

- Revision and extension of the utilization categories (see hereafter)
- Replacement of the coordination classes types a, b, c by new types: "1" (approximately equivalent to former class "a") and "2" (approximately equivalent to former class "c") with additional requirements.
- Classification of the thermal overload relays in tripping classes: 10 A; 10; 20 and 30 depending on their tripping times, at 1.5 and 7.2 times their setting current, in order to cover motor applications depending on their starting times. Class 10 A is adapted for motors according to IEC 34-1.
- Introduction of tests to verify the connecting capability and the mechanical strength of terminals.

Utilization categories

A contactor duty is characterized by the utilization category plus indication of the rated operating voltage and the rated operating current (see at Rated ...), or the motor characteristics.

Utilization categories for contactors according to IEC 947-4-1

Alternating current:	AC-1	Non-inductive or slightly inductive loads, resistance furnaces. Power factor 0.7 - 0.8 (slightly inductive).
	AC-2	Slip-ring motors: starting, switching-off.
	AC-3	Squirrel-cage motors: starting, switching-off motors during running. Power factor 0.4 - 0.5 (AC-3).
	AC-4	Squirrel-cage motors: starting, plugging, inching.
	AC-5a	Switching of electric discharge lamp controls.
	AC-5b	Switching of incandescent lamps.
	AC-6a	Switching of transformers.
	AC-6b	Switching of capacitor banks
	AC-8a	Hermetic refrigerant compressor motor control with manual resetting of overload releases
AC-8b	Hermetic refrigerant compressor motor control with automatic resetting of overload releases.	
Direct current:	DC-1	Non-inductive or slightly inductive loads, resistance furnaces.
	DC-3	Shunt motors: starting, plugging, inching. Dynamic breaking of d.c. motors.
	DC-5	Series motors: starting, plugging, inching. Dynamic breaking of d.c. motors.
	DC-6	Switching of incandescent lamps

Utilization categories for contactor relays according to IEC 947-5-1

Alternating current:	AC-12	Control of resistive loads and solid state loads with isolation by opto couplers.
	AC-13	Control of solid state loads with transformer isolation.
	AC-14	Control of small electromagnetic loads (≤ 72 VA).
	AC-15	Control of electromagnetic loads (> 72 VA).
Direct current:	DC-12	Control of resistive loads and solid state loads with isolation by opto couplers.
	DC-13	Control of electromagnets.
	DC-14	Control of electromagnetic loads having economy resistors in circuit.

Utilization categories AC-1, AC-2, AC-3, AC-4 and DC-1, DC-3, DC-5 are maintained with slightly more severe tests.

Other categories have been added in order to standardize specific applications. In fact some contactor applications and the specific criteria characterizing the types of load controlled can modify the recommended utilization characteristics. These major applications are, for example :

Switching of capacitor banks

This application is characterized by high current peaks when switching-on the contactor and presence of harmonic currents on uninterrupted duty. For this application, IEC 947-4-1 has defined an utilization category AC-6b. Practical ratings have to be defined according to tests or, in absence of tests, by a calculation indicated in IEC 947-4-1.

Switching of transformers

This application is characterized by high current peaks on contactor closing due to magnetization phenomena. The corresponding utilization category according to IEC 947-4-1 is AC-6a. Ratings are derived from test-values for AC-3 or AC-4 according to formula given in IEC 947-4-1.

Switching of lighting circuits

The current peaks on contactor closing and power factor vary depending on the type of lamps, the switching method used and if compensation systems are fitted or not.

IEC 947-4-1 contains two standard utilization categories

- AC-5a for switching of the electric discharge lamps.
- AC-5b for switching of incandescent lamp.

UL/CSA Technical data

Motor data

Ampere ratings of 3 phase, AC induction motors

Horse power	110 – 120V			200 – 208V			220 – 240V			380 – 415V ^①		440 – 480V			550 – 600V		
	Single phase	Two phase	Three phase	Single phase	Two phase	Three phase	Single phase	Two phase	Three phase	Single phase	Three phase	Single phase	Two phase	Three phase	Single phase	Two phase	Three phase
1/10	3.0	—	—	1.65	—	—	1.5	—	—	1.0	—	—	—	—	—	—	—
1/8	3.8	—	—	2.1	—	—	1.9	—	—	1.2	—	—	—	—	—	—	—
1/6	4.4	—	—	2.4	—	—	2.2	—	—	1.4	—	—	—	—	—	—	—
1/4	5.8	—	—	3.2	—	—	2.9	—	—	1.8	—	—	—	—	—	—	—
1/3	7.2	—	—	4.0	—	—	3.6	—	—	2.3	—	—	—	—	—	—	—
1/2	9.8	4.0	4.4	5.4	2.2	2.4	4.9	2.0	2.2	3.2	1.3	2.5	1.0	1.1	2.0	0.8	0.9
3/4	13.8	4.8	6.4	7.6	2.6	3.5	6.9	2.4	3.2	4.5	1.8	3.5	1.2	1.6	2.8	1.0	1.3
1	16.0	6.4	8.4	8.8	3.6	4.6	8.0	3.2	4.2	5.1	2.3	4.0	1.6	2.1	3.2	1.3	1.7
1 1/2	20.0	9.0	12.0	11.0	5.0	6.6	10.0	4.5	6.0	6.4	3.3	5.0	2.3	3.0	4.0	1.8	2.4
2	24.0	11.8	13.6	13.2	6.5	7.5	12.0	5.9	6.8	7.7	4.3	6.0	3.0	3.4	4.8	2.4	2.7
3	34.0	16.6	19.2	18.7	9.2	10.6	17.0	8.3	9.6	10.9	6.1	8.5	4.2	4.8	6.8	3.3	3.9
5	56.0	26.4	30.4	30.8	14.5	16.8	28.0	13.2	15.2	17.9	9.7	14.0	6.6	7.6	11.2	5.3	6.1
7 1/2	80.0	38.0	44.0	44.0	21.0	24.2	40.0	19.0	22.0	27.0	14.0	21.0	9.0	11.0	16.0	8.0	9.0
10	100.0	48.0	56.0	55.0	26.4	30.8	50.0	24.0	28.0	33.0	18.0	26.0	12.0	14.0	20.0	10.0	11.0
15	135.0	72.0	84.0	75.0	39.6	46.2	68.0	36.0	42.0	44.0	27.0	34.0	18.0	21.0	27.0	14.0	17.0
20	—	94.0	108.0	96.8	52.0	60.0	88.0	47.0	54.0	56.0	34.0	44.0	23.0	27.0	35.0	19.0	22.0
25	—	118.0	136.0	121.0	65.0	75.0	110.0	59.0	68.0	70.0	44.0	55.0	29.0	34.0	44.0	24.0	27.0
30	—	138.0	160.0	150.0	76.0	88.0	136.0	69.0	80.0	87.0	51.0	68.0	35.0	40.0	54.0	28.0	32.0
40	—	180.0	208.0	194.0	100.0	115.0	176.0	90.0	104.0	112.0	66.0	88.0	45.0	52.0	70.0	36.0	41.0
50	—	226.0	260.0	238.0	125.0	143.0	216.0	113.0	130.0	139.0	83.0	108.0	56.0	65.0	86.0	45.0	52.0
60	—	—	—	—	147.0	160.0	—	133.0	154.0	—	103.0	—	67.0	77.0	—	53.0	62.0
75	—	—	—	—	183.0	212.0	—	166.0	192.0	—	128.0	—	83.0	96.0	—	66.0	77.0
100	—	—	—	—	240.0	273.0	—	218.0	248.0	—	165.0	—	109.0	124.0	—	87.0	99.0
125	—	—	—	—	—	344.0	—	—	312.0	—	208.0	—	135.0	156.0	—	108.0	125.0
150	—	—	—	—	—	396.0	—	—	360.0	—	240.0	—	156.0	180.0	—	125.0	144.0
200	—	—	—	—	—	528.0	—	—	480.0	—	320.0	—	208.0	240.0	—	167.0	192.0
250	—	—	—	—	—	663.0	—	—	602.0	—	403.0	—	—	302.0	—	—	242.0
300	—	—	—	—	—	—	—	—	—	—	482.0	—	—	361.0	—	—	289.0
350	—	—	—	—	—	—	—	—	—	—	560.0	—	—	414.0	—	—	336.0
400	—	—	—	—	—	—	—	—	—	—	636.0	—	—	477.0	—	—	382.0
500	—	—	—	—	—	—	—	—	—	—	786.0	—	—	590.0	—	—	472.0

① To obtain full load currents for 265V and 277V motors, decrease corresponding 220 – 240V ratings by 13 percent and 17 percent.

Approximate dimensions A/AE9 – A/AE26, 3 pole

00.00 Inches
00.00 [Millimeters]

A/AE9 – A/AE16 – Contactor, 3 pole

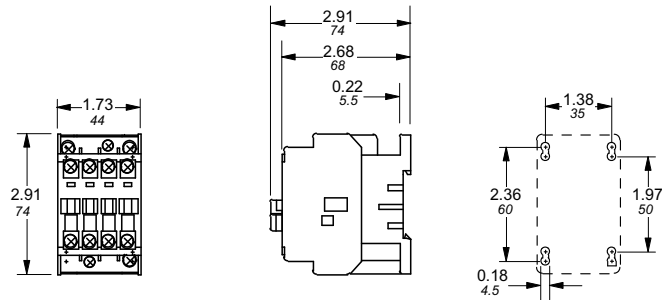

A/AE9 – A/AE16 + VM5 or VE5 – Mechanically interlocked contactor, 3 pole

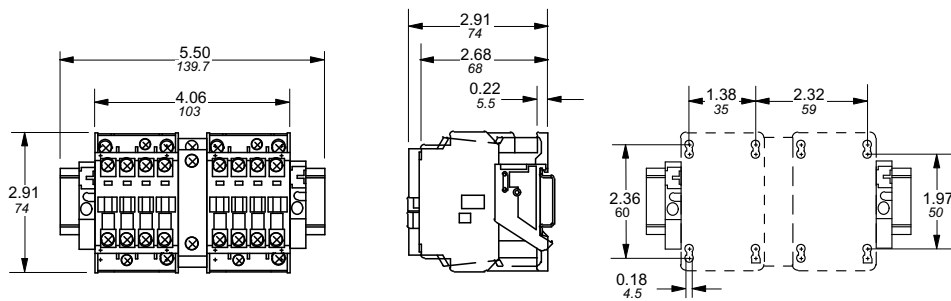

A/AE26 – Contactor, 3 pole

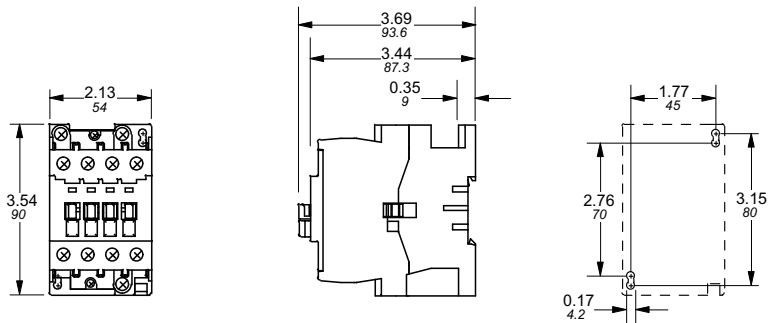

A/AE26 + VM5 or VE5 – Mechanically interlocked contactor, 3 pole

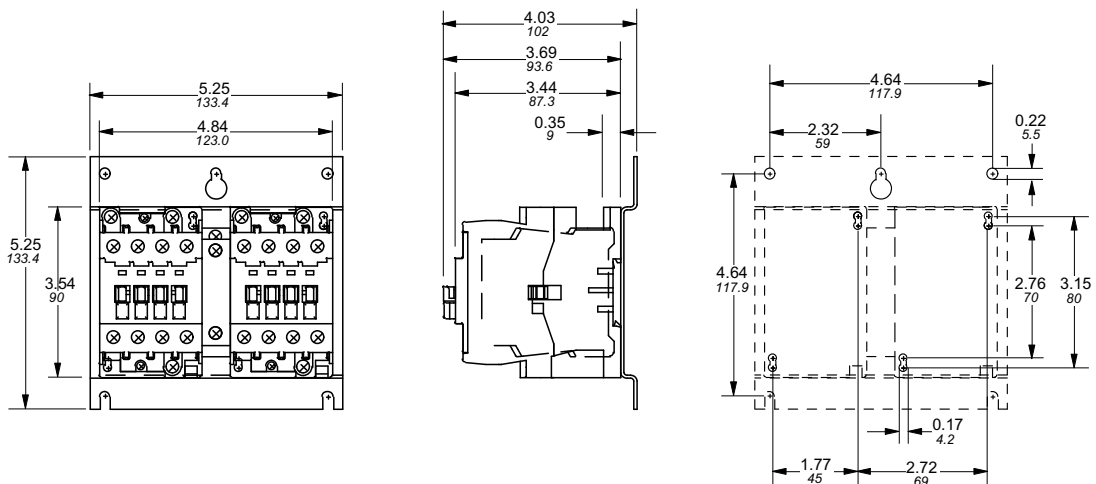

Approximate dimensions A/AE30 – A/AE/AF75, 3 pole

00.00 Inches
00.00 [Millimeters]

A/AE30 & A/AE40 – Contactor, 3 pole

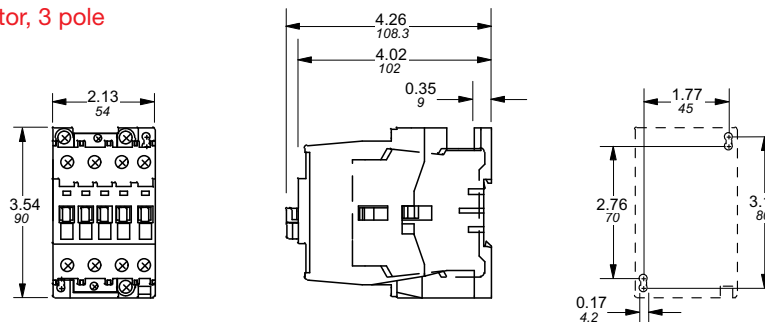

A/AE30 & A/AE40 + VM5 or VE5 – Mechanically interlocked contactor, 3 pole

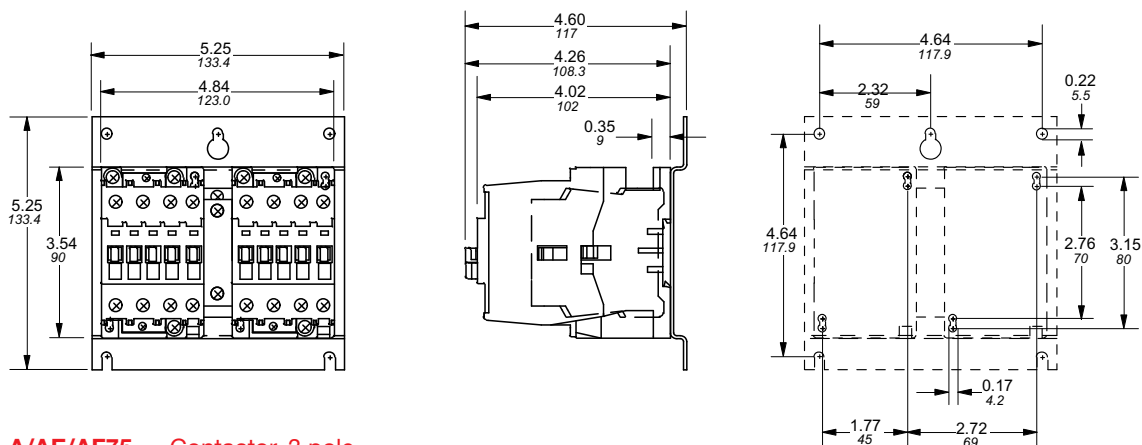

A/AE/AF50 – A/AE/AF75 – Contactor, 3 pole

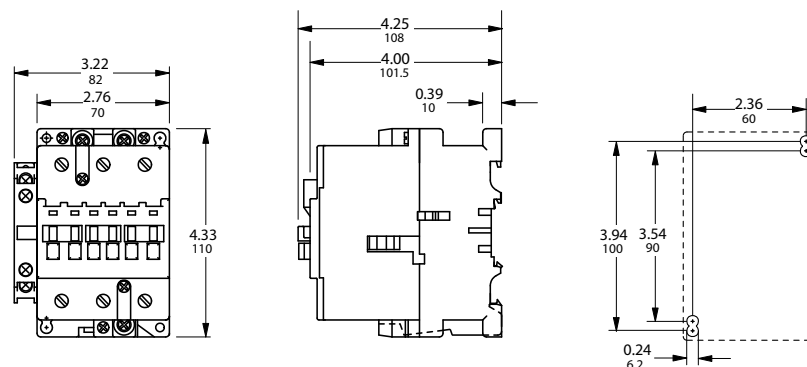

A/AE/AF50 – A/AE/AF75 + VM5 or VE5 – Mechanically interlocked contactor, 3 pole

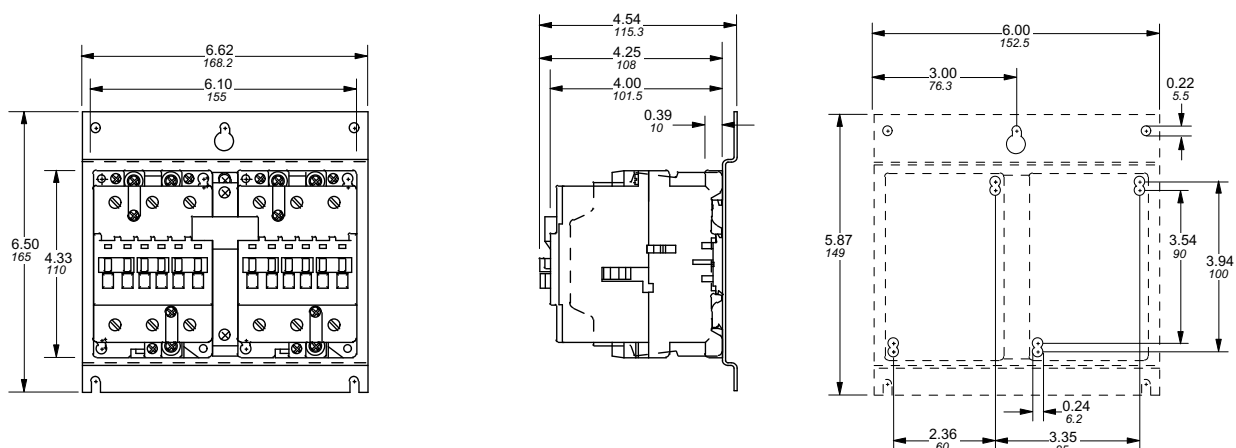

Approximate dimensions A/AE/AF95 & A/AE/AF110, 3 pole

Across the line
1

00.00 Inches
00.00 [Millimeters]

A/AE/AF95 & A/AE/AF110 – Contactor, 3 pole

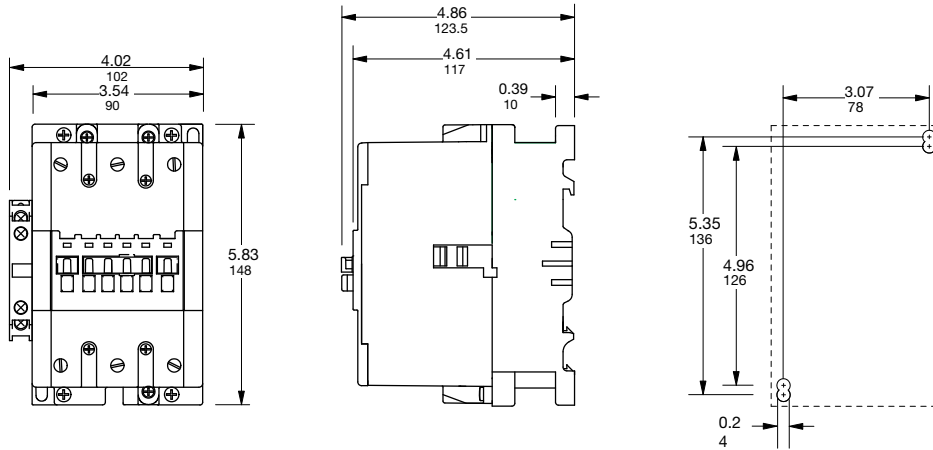

A/AE/AF95 & A/AE/AF110 + VE5 – Mechanically interlocked contactor, 3 pole

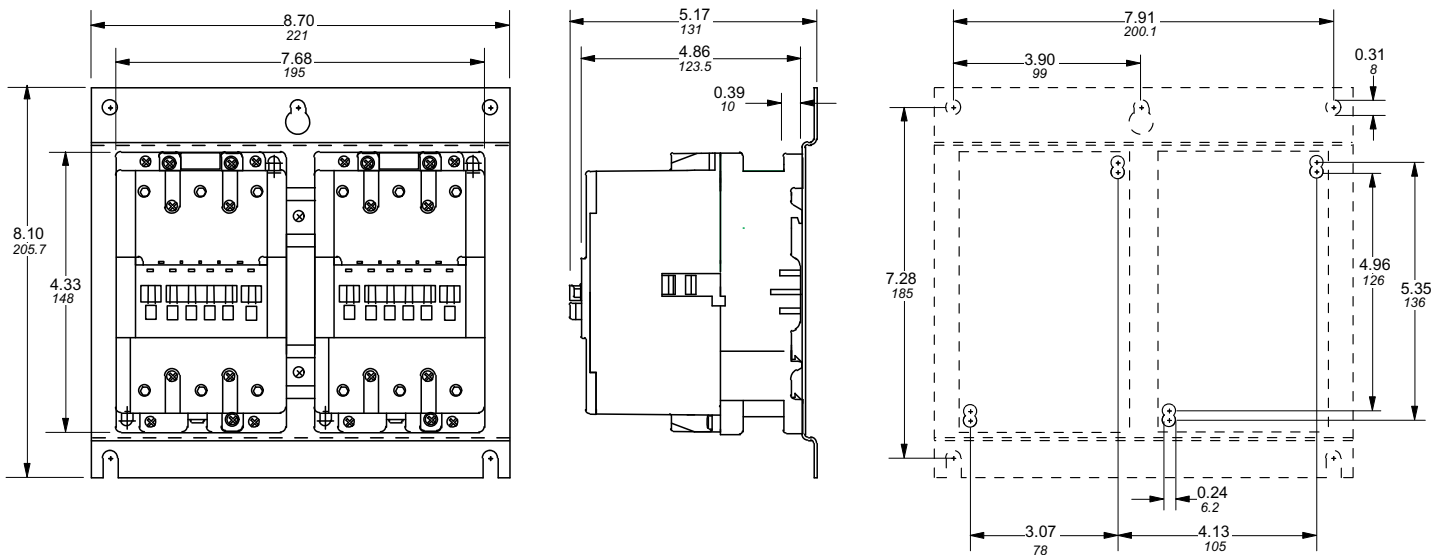

Approximate dimensions A/AE9 – A/AE/AF75, 4 pole

00.00 Inches
00.00 [Millimeters]

A/AE9 – A/AE16 – Contactor, 4 pole

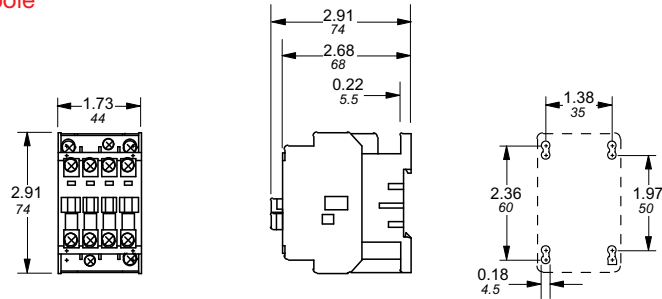

A/AE26 – Contactor, 4 pole

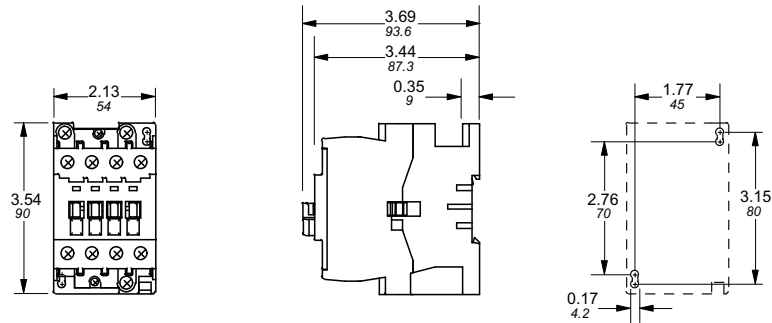

A/AE/AF45 – A/AE/AF75 – Contactor, 4 pole

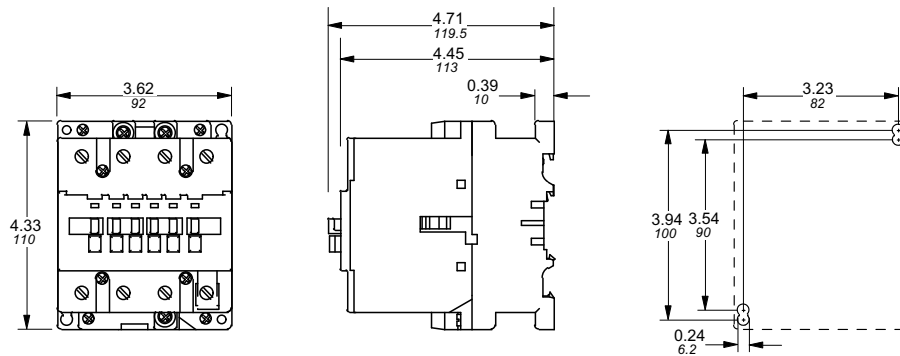

Approximate dimensions AL9 – AL40, 3 & 4 pole

00.00 Inches
00.00 [Millimeters]

AL9, AL12, AL16 – Contactor, 3 & 4 pole

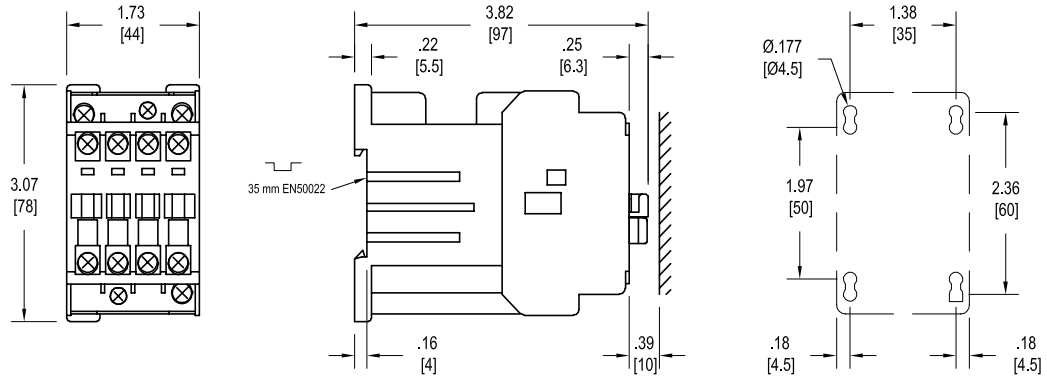

AL26 – Contactor, 3 & 4 pole

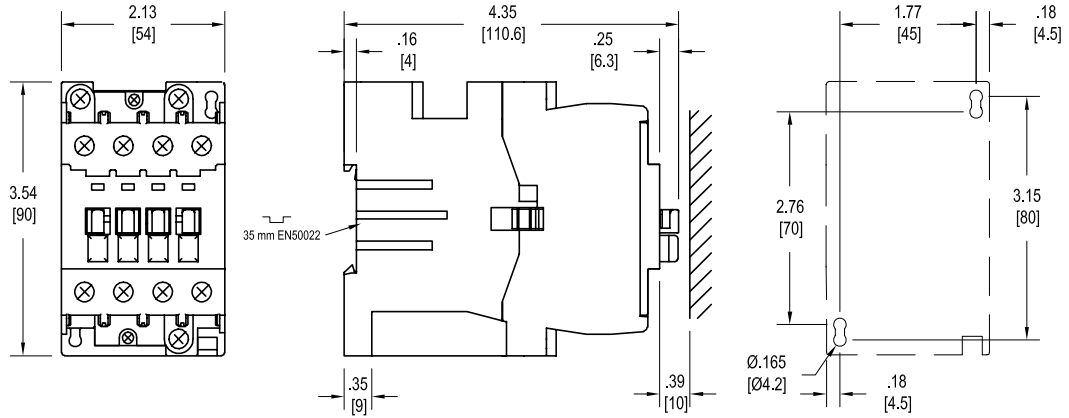

AL30, AL40 – Contactor, 3 pole

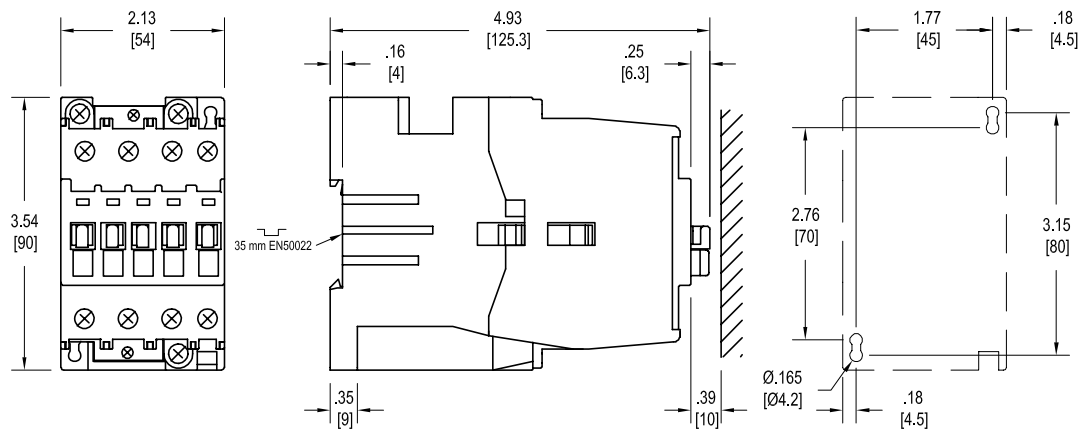

Approximate dimensions

Accessories for A/AE9 – A/AE/AF110

00.00 Inches
00.00 [Millimeters]

A/AE9 – A/AE40
A/AE/AF50 – A/AE/AF110

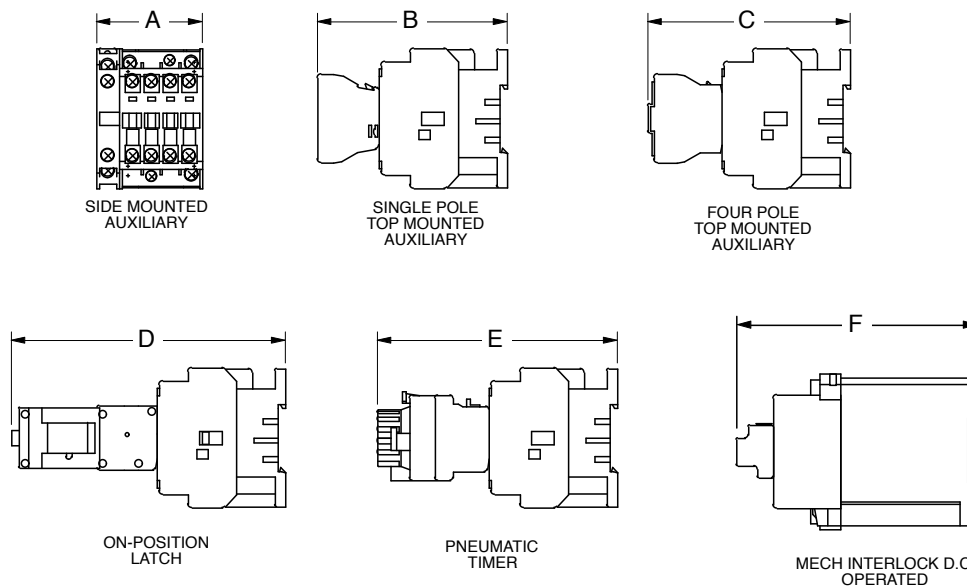

TYPE		A	B	C	D	E	F
A/AE9-16	IN MM	2.20 56	3.96 100.5	4.21 107	5.71 145	5.00 127	– –
A/AE26	IN MM	2.20 56	4.72 119.8	4.97 126.3	6.47 164.3	5.76 146.3	– –
A/AE30-40	IN MM	2.20 56	5.30 134.5	5.55 141	7.05 179	6.34 161	– –
A/AE/AF50-75	IN MM	3.23 82	5.27 133.9	5.52 140.3	7.03 178.5	6.32 160.4	– –
A/AE/AF45	IN MM	4.09 104	5.73 145.5	5.98 152	7.48 190	6.77 172	– –
A/AE/AF95-110	IN MM	4.02 102	5.91 150	6.16 156.5	– –	– –	– –

Approximate dimensions A/AF145 – A/AF185

Across the line
1

00.00 Inches
00.00 [Millimeters]

A/AF145 & A/AF185

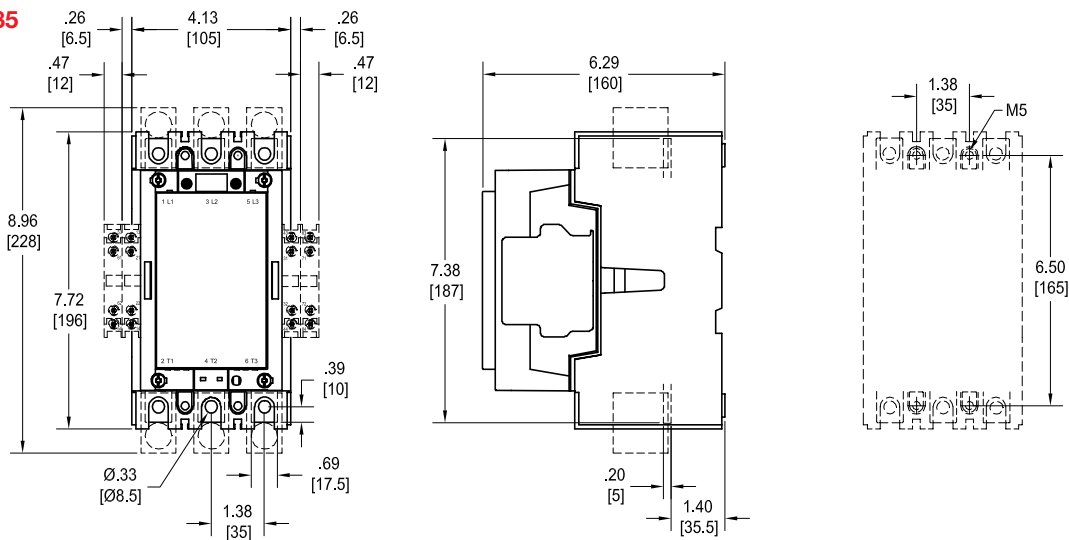

A/AF145, A/AF185 with mechanical interlock

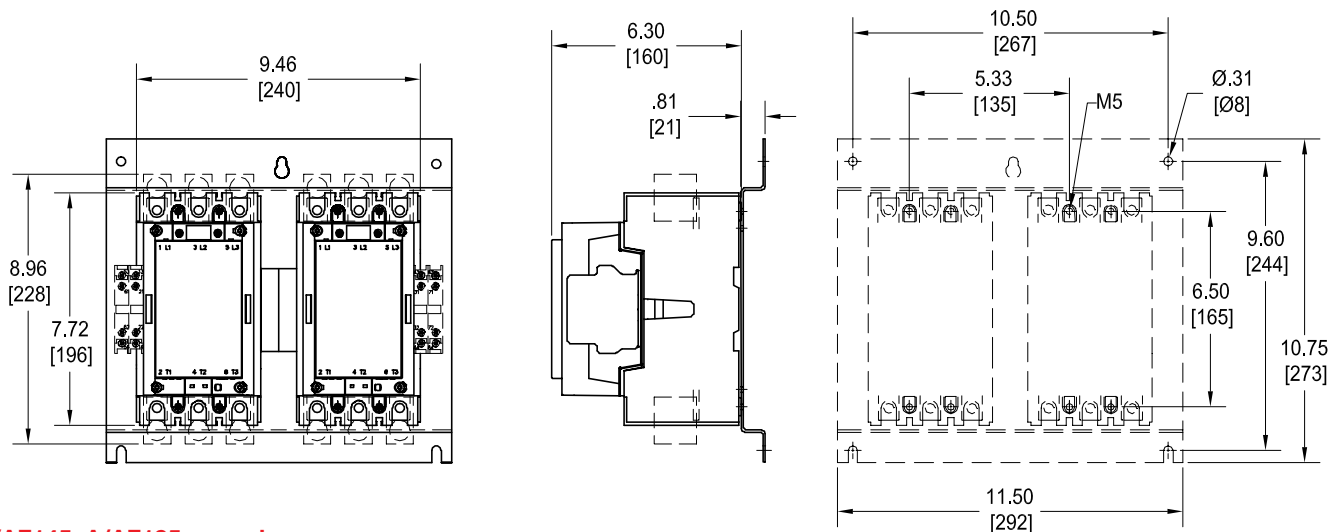

A/AF145, A/AF185 reversing

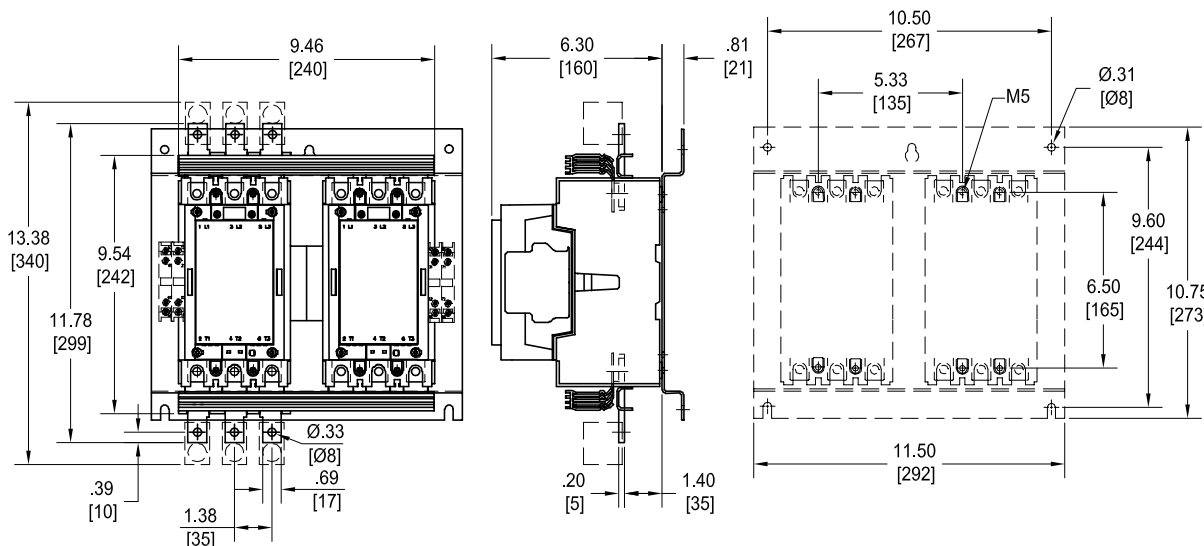

Approximate dimensions A/AF145 – A/AF300

00.00 Inches
00.00 [Millimeters]

A/AF145 – A/AE/AF95-110 mechanically interlocked

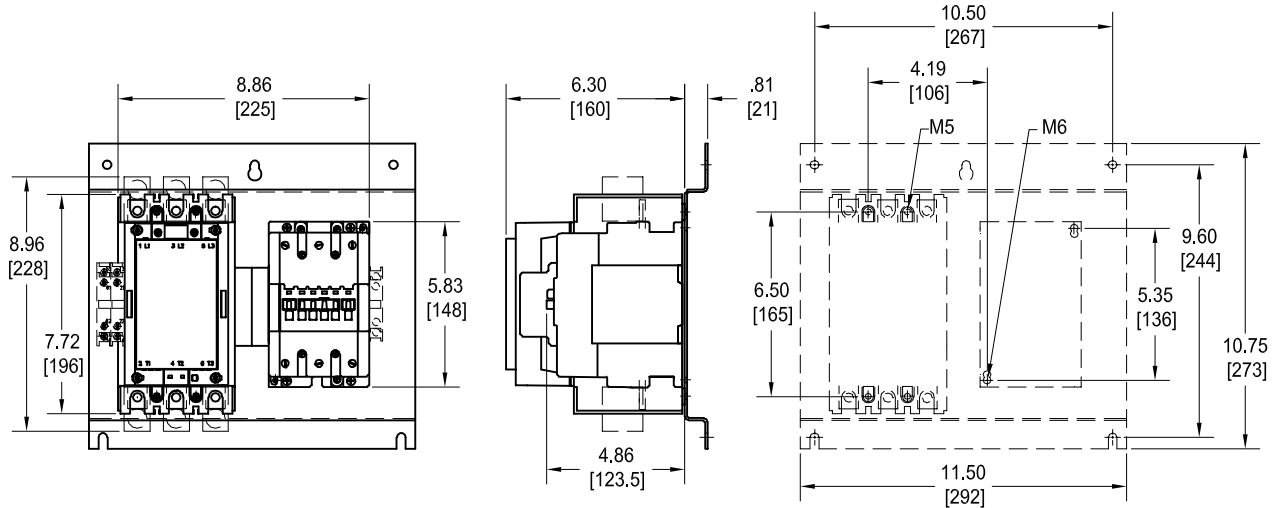

A/AF210, A/AF260, A/AF300

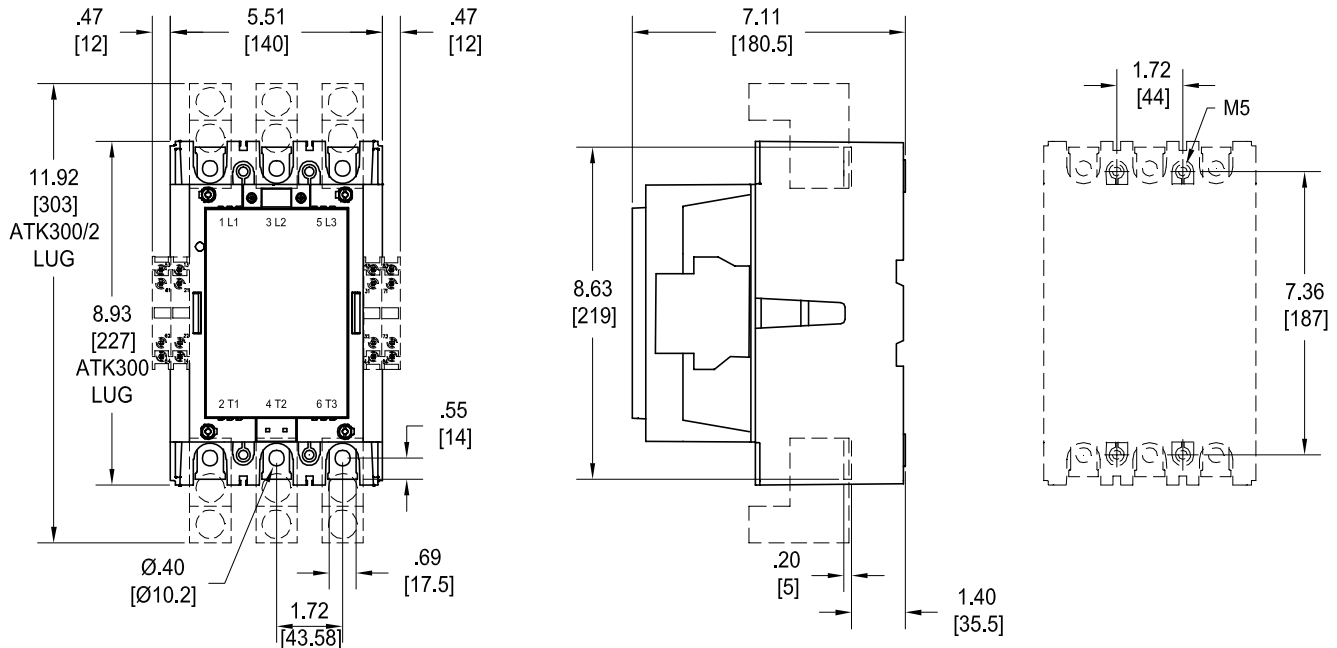

Approximate dimensions A/AF210 – A/AF300

00.00 Inches
00.00 [Millimeters]

A/AF210, A/AF260, A/AF300 with mechanical interlock

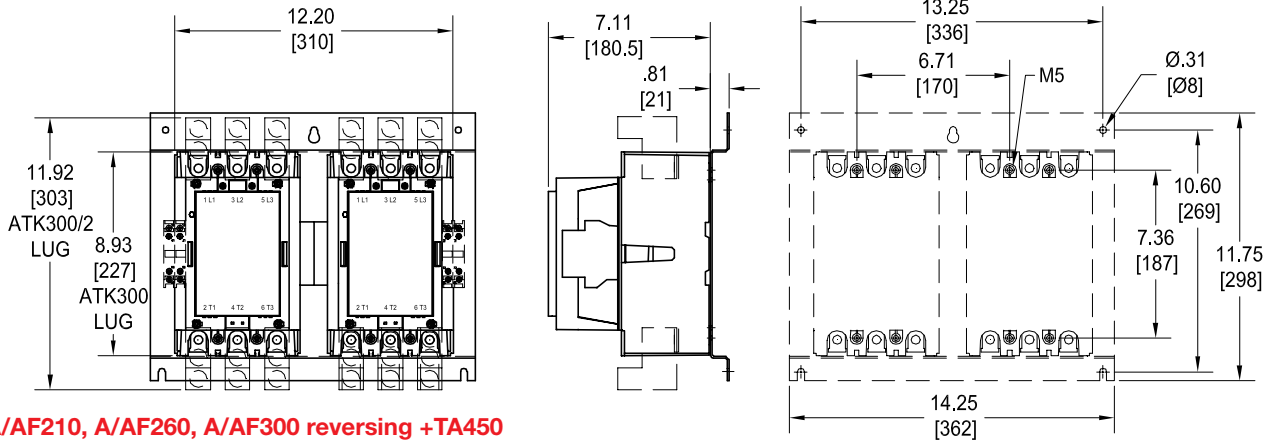

A/AF210, A/AF260, A/AF300 reversing +TA450

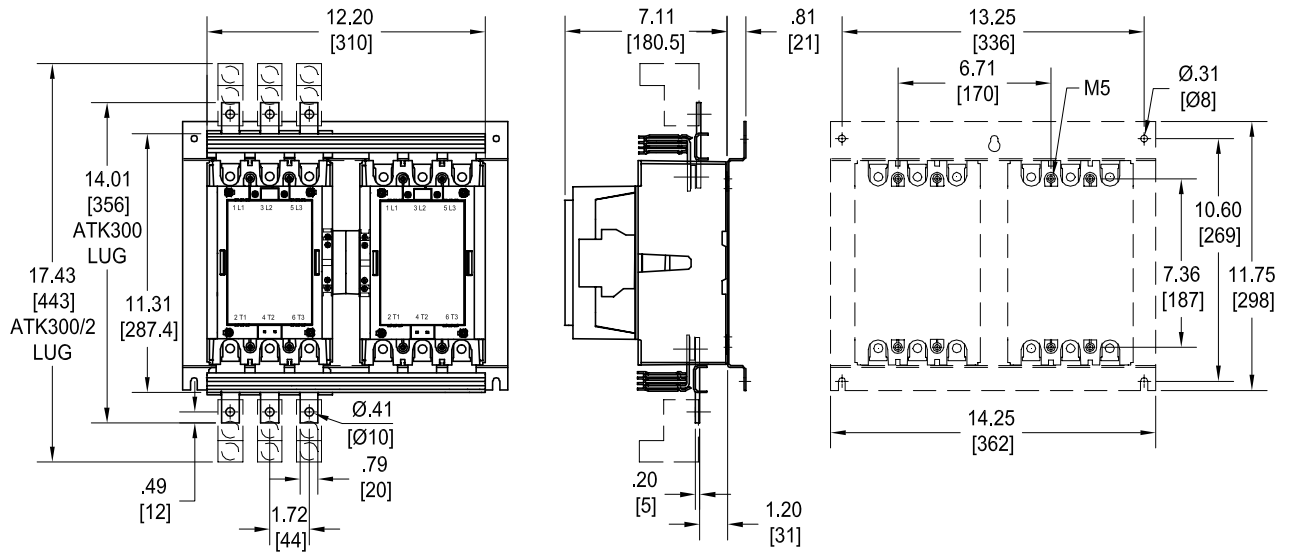

A/AF210, A/AF145 with mechanical interlock

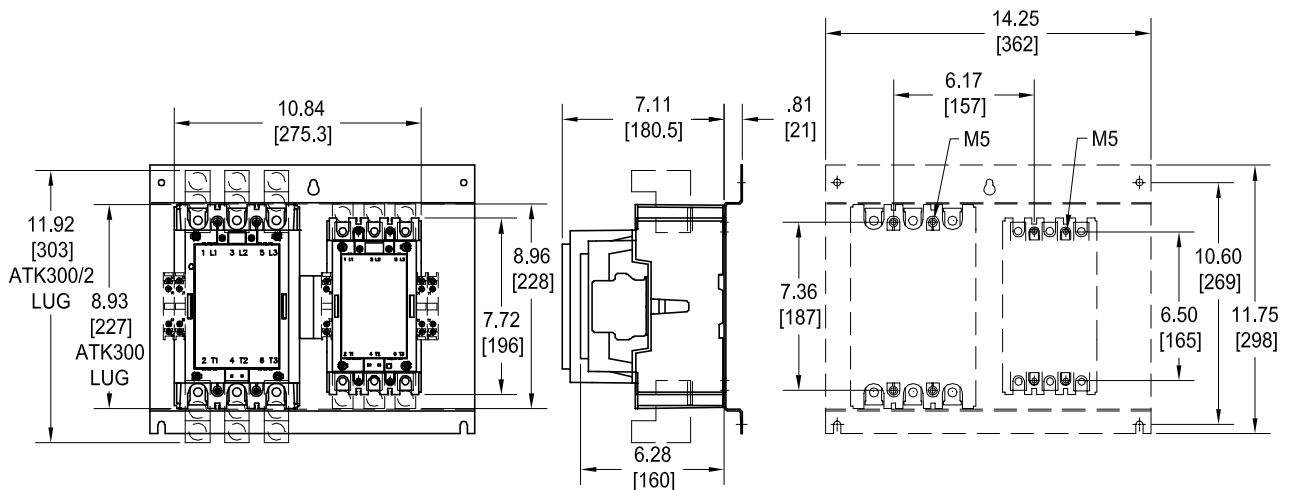

Approximate dimensions AF400 – AF460

00.00 Inches
00.00 [Millimeters]

AF400, AF460

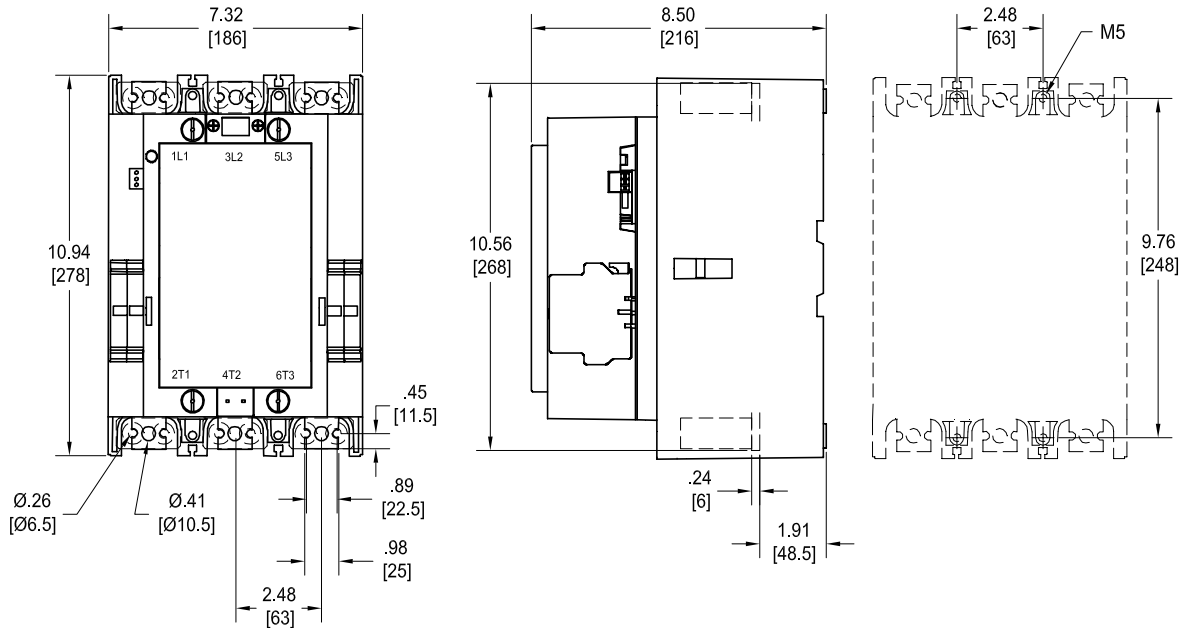

AF400, AF460 with mechanical interlock

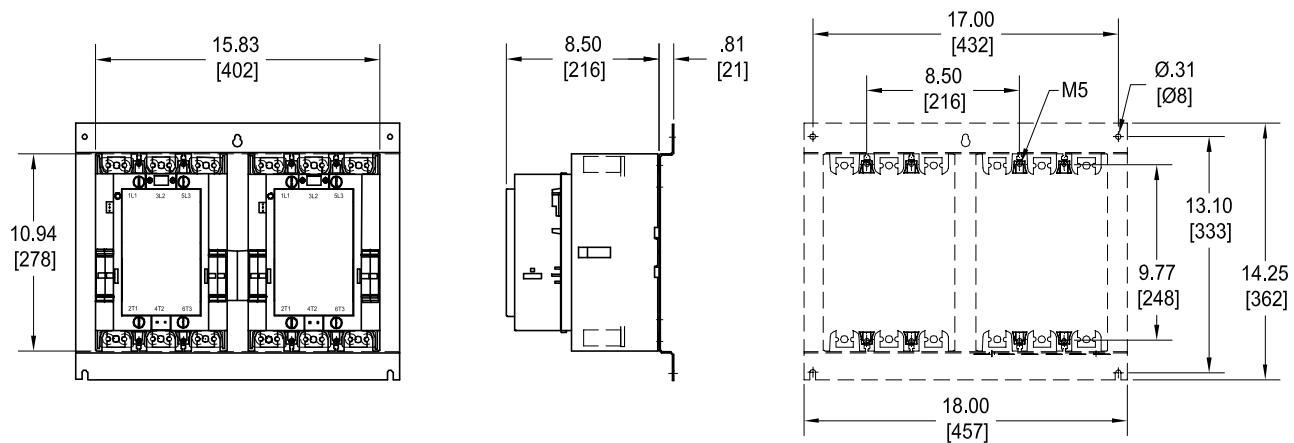

Approximate dimensions AF400 – AF750

00.00 Inches
00.00 [Millimeters]

AF400, AF460 reversing

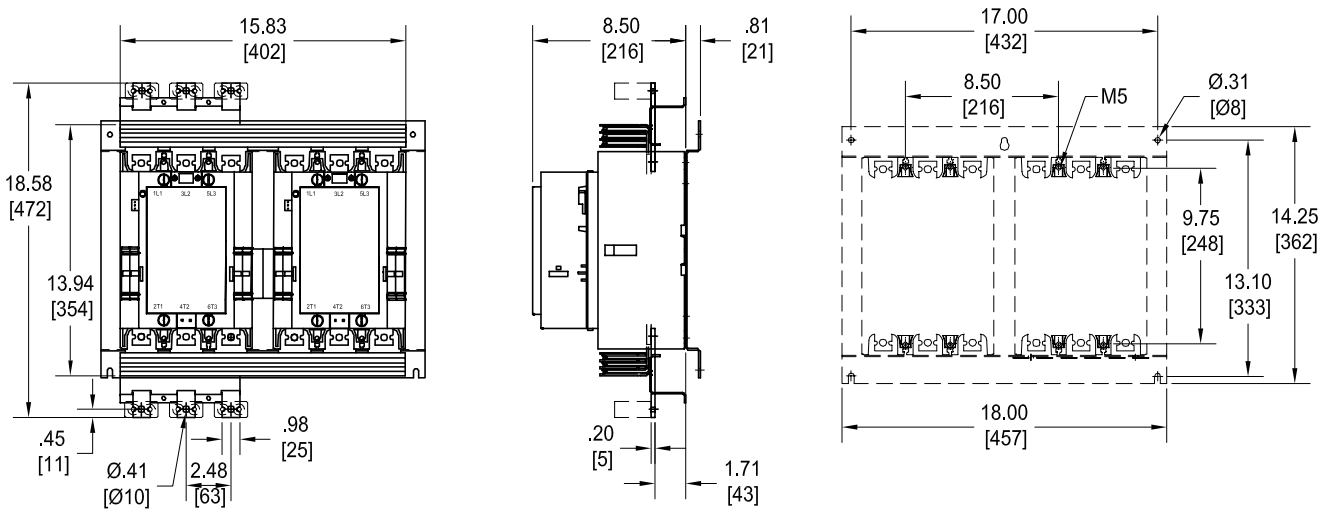

AF580 – AF750

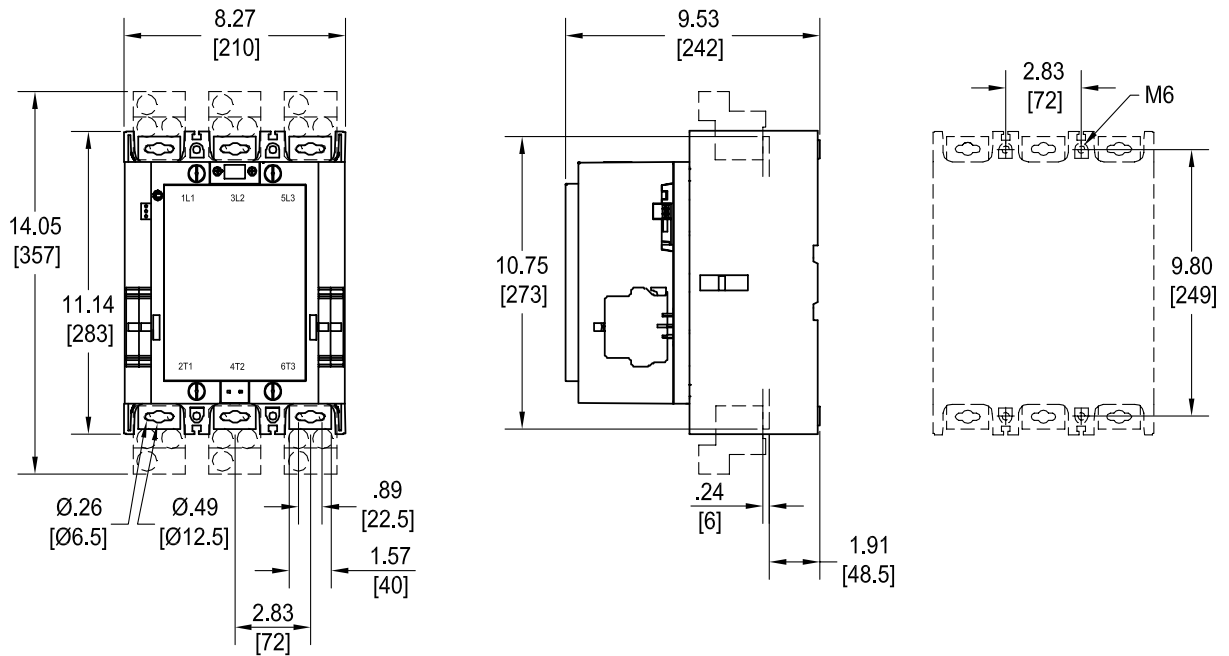

Approximate dimensions AF580 – AF750

00.00 Inches
00.00 [Millimeters]

AF580 – AF750 with mechanical interlock

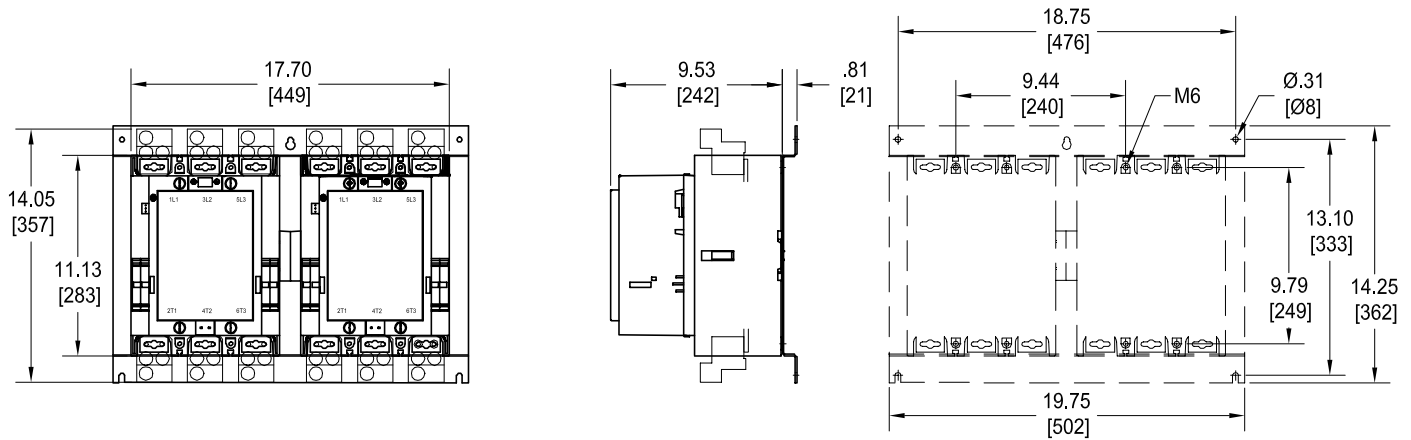

AF580 – AF750 reversing

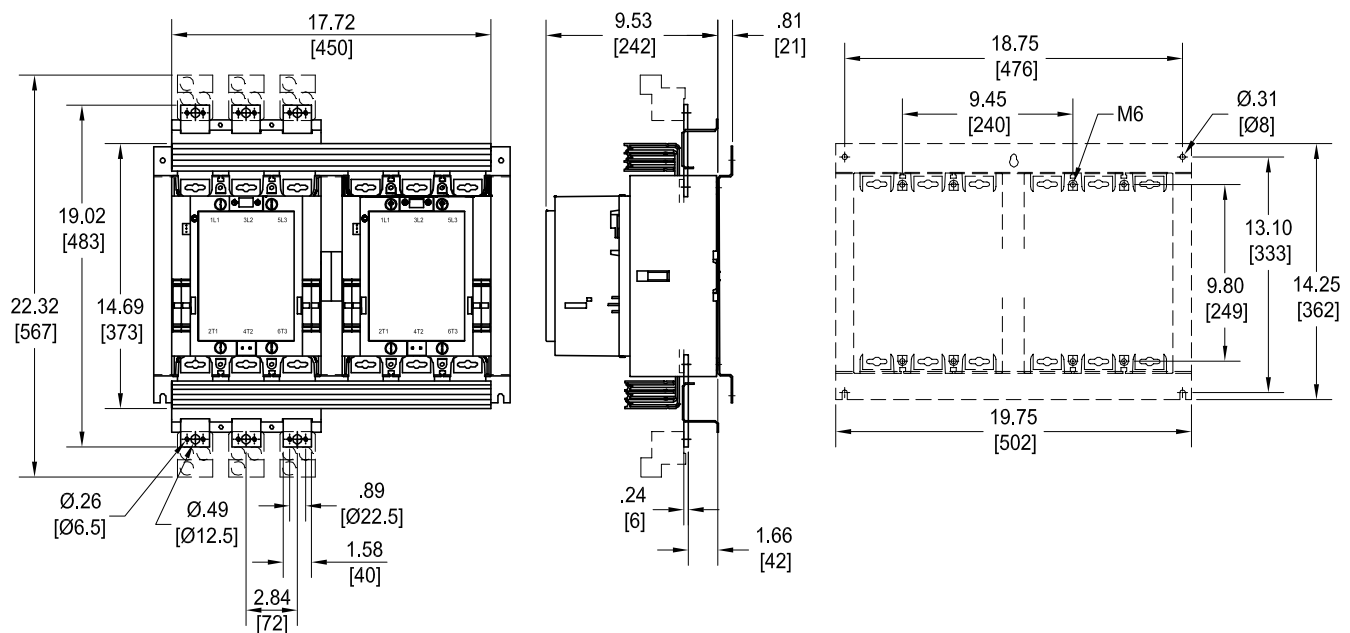

Approximate dimensions AF1350 – AF1650

Across the line
1

00.00 Inches
00.00 [Millimeters]

AF1350 – AF1650

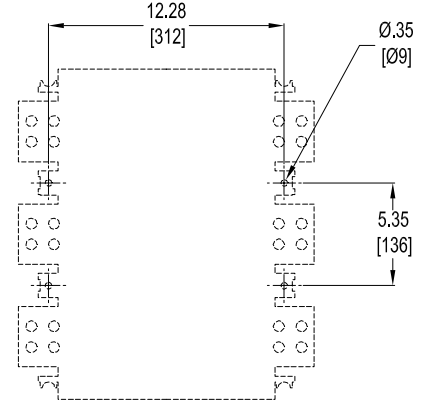
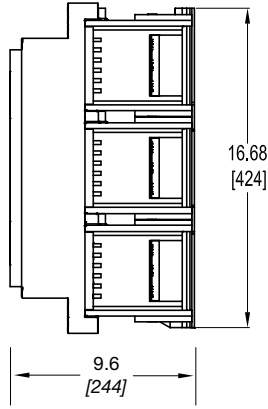
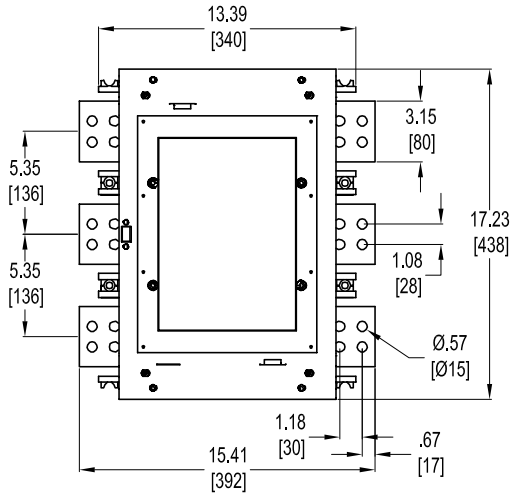

Approximate dimensions EK110 – EK550, 4 pole

00.00 Inches
00.00 [Millimeters]

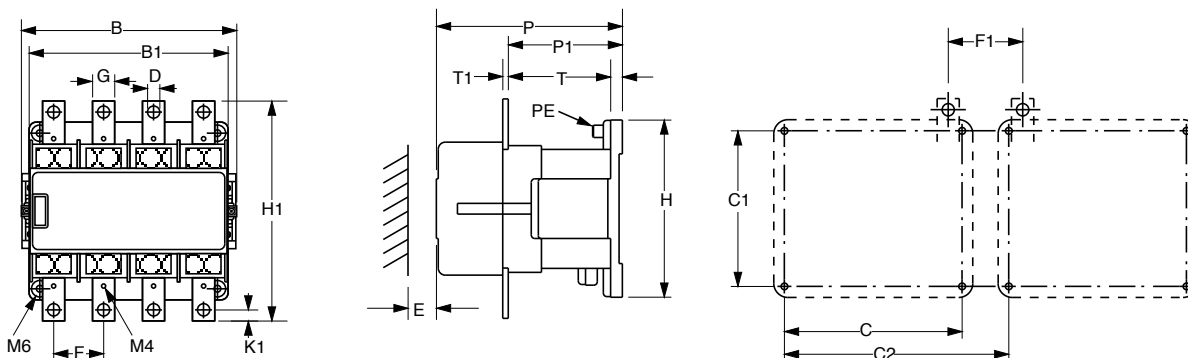

		B	B1	C	C1	D	E	F	F1	G	H	H1	K1	P	P1	T	T1
EK 110	in	6.50	5.35	4.72	5.51	0.26	1.57	1.61	1.69	0.59	6.14	6.14	0.30	6.08	4.03	0.39	0.16
	mm	165	136	120	140	6.6	40	41	43	15	156	156	7.5	154.5	102.3	10	4
EK 150	in	6.50	5.35	4.72	5.51	0.43	1.57	1.65	1.65	0.79	6.14	6.77	0.39	6.08	4.03	0.39	0.16
	mm	165	136	120	140	11	40	42	42	20	156	172	10	154.5	102.3	10	4
EK 175	in	7.91	6.93	6.30	5.51	0.43	0.59	1.77	2.64	0.79	6.14	7.80	0.39	6.77	4.20	0.39	0.20
	mm	201	176	160	140	11	15	45	67	20	156	198	10	172	106.7	10	5
EK 210	in	7.91	6.93	6.30	5.51	0.43	0.59	1.77	2.64	0.79	6.14	7.80	0.39	6.77	4.20	0.39	0.20
	mm	201	176	160	140	11	15	45	67	20	156	198	10	172	106.7	10	5
EK 370	in	10.63	9.61	8.66	7.87	0.43	1.57	2.64	2.76	0.98	8.78	10.71	0.49	8.88	5.49	0.91	0.24
	mm	270	244	220	200	11	40	67	70	25	223	272	12.5	225.5	139.5	23	6
EK 550	in	10.63	9.61	8.66	7.87	0.43	1.57	2.64	2.76	0.98	8.78	10.71	0.49	8.88	5.49	0.91	0.24
EK 1000	mm	270	244	220	200	11	40	67	70	25	223	272	12.5	225.5	139.5	23	6



Definite purpose Contactors

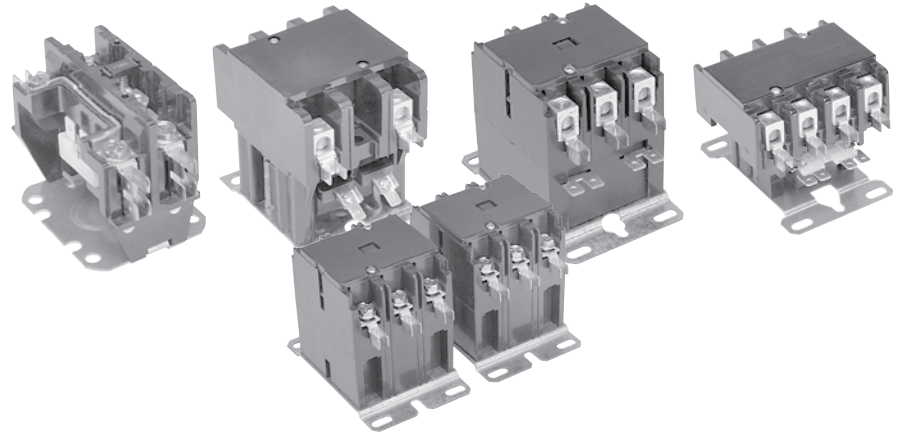

Applications

Type DP contactors provide high performance with flexibility and reliability, designed to match numerous applications including:

- Motors
- Power supplies
- Food service equipment
- Compressors
- Business machines
- Resistive heating
- Air conditioning
- Refrigeration equipment
- Welding

Agency approvals

- UL 508 Guide No. NLDX2, File # E224401
- CE/Semko Certified
- EN60947-4-1:1991
- IEC 947-4-1

Features

- Available as:
 - 30A, 1, 2, 3 or 4 pole
 - 40A, 1, 2, 3 or 4 pole
 - 60A, 3 pole
- Industry standard mounting plate provides easily accessible mounting holes
- Coil terminals are provided with #6-32 screws and (1) .250 quick connect or dual .250 quick connect terminals
- Exclusive hex, slotted, phillips #10-32 terminal screws for main terminals
- Coil is Class B (130° C) Insulation system with wide range of voltages and 50/60 Hz ratings
- Double E Magnet Assembly provides optimal performance with reduced power consumption
- Snap-in auxiliary switch with 1 SPDT or 2 SPDT contacts available as an option
- 1 NO & 1 NC auxiliary contact block with 600 VAC rating available as an option
- Base assembly is made from high arc-resistant plastic

Catalog number explanation

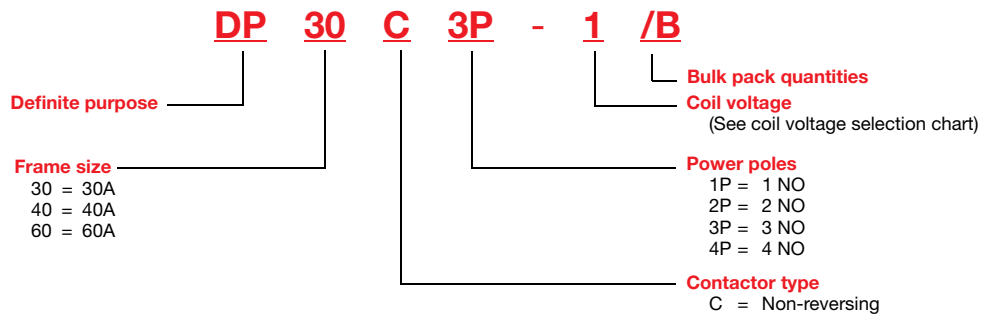

30A, 40A & 60A 1, 2, 3, & 4 Pole

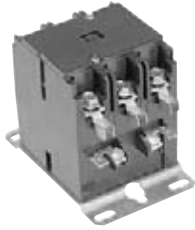

DP30C3P-F

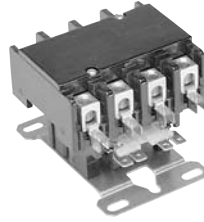

DP40C4P-F

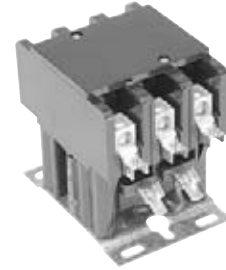

DP60C3P-F

30A, 40A & 60A

Full load amps	No. of poles	Locked motor amps			Resistive amps	Maximum HP 1 phase		Maximum HP 3 phase				Individual pack		Bulk pack		
		240/277V	480V	600V		120V	240V	200/208V	240/277V	480V	600V	Catalog number	List price	Bulk pack ①	Catalog number	List price
30	1	150	75	50	40	1	2	—	—	—	—	DP30C1P-F	\$ 30	50	DP30C1P-F/B	\$ 27
30	2	150	125	100	40	2	3	—	—	—	—	DP30C2P-F	38	50	DP30C2P-F/B	34
30	3	180	150	120	40	2	5	10	10	15	20	DP30C3P-F	55	25	DP30C3P-F/B	50
30	4	180	150	120	40	2	5	10	10	10	—	DP30C4P-F	75	25	DP30C4P-F/B	68
40	2	240	200	160	50	2	3	—	—	—	—	DP40C2P-F	46	50	DP40C2P-F/B	42
40	3	240	200	160	50	3	7.5	10	10	20	25	DP40C3P-F	60	25	DP40C3P-F/B	54
40	4	240	200	160	50	3	7.5	10	10	10	—	DP40C4P-F	100	25	DP40C4P-F/B	90
60	3	360	300	240	75	2	10	25	25	30	30	DP60C3P-F	147	—	—	—

Coil voltage selection chart

Voltage	24VAC	120VAC	208/240VAC	277VAC	480VAC	575VAC
Suffix #	F	1	2	C	4	5

Coil voltage selection

All catalog numbers include a 24VAC coil. To select other coil voltages, substitute the code from the Coil Voltage Selection Chart for the first digit after the dash in the catalog number.

Auxiliary contact blocks (3 pole only)

Description	Catalog number 30A - 40A	Catalog number 60A	List price
NO or NC SPDT 1 NO & 1 NC	CADP40-10 CADP40-11	CADP60-10 —	\$ 10

Contact rating of 1 NO & 1 NC

		120V	240V	480V	600V
Break	A	3.0	1.5	.75	.6
Make	A	30	15	7.5	6
Continuous	A	10	10	10	10

Quick connect terminals on all auxiliary switches are .250 wide.

Contact rating of SPDT

Voltage	Current rating
125VAC	10A, 1/3 HP
120VAC	4A on lamp load
250VAC	10A, 1/3 HP
125VDC	.5A
250VDC	.25A

Ordering bulk quantities

To order bulk package quantities add "/B" to the end of the catalog number.

Example: For quantities of 25 of a 30A 3 pole contactor with 24VAC coil, the catalog number would be: DP30C3P-F/B

Mechanical interlock

Frame size	Catalog number	List price
DP30 DP40	VMDP-1	\$ 7

① Must be ordered in standard pack quantities as shown. Add suffix "/B" to the catalog number.

Technical data

30A – 60A

1, 2, 3, & 4 Pole

Definite purpose
contactors

1

30A – 40A – 1 & 2 pole

Coil technical data		DP30C1P				DP30, DP40C2P			
Nominal coil voltage		24	120	208/240	277	24	120	208/240	277
Maximum pickup volts		18	88	177	221	18	88	177	221
Drop-out volts range		6 – 15	20 – 70	40 – 170	50 – 165	6 – 15	20 – 70	40 – 140	50 – 165
Nominal inrush VA	50 Hz	31	31	35	31	22	22	22	22
Nominal inrush VA	60 Hz	28	28	32	28	20	20	20	20
Nominal sealed VA	50 Hz	6	6	7	6	5.5	5.5	5.5	5.5
Nominal sealed VA	60 Hz	5	5	6	5	4.5	4.5	4.5	4.5
Nominal DC resistance	Ohms	17.5	450	1800	2252	13	275	1056	1772
Other specifications		DP30C1P				DP30, DP40C2P			
Line and load terminals		# 10 – 32 screw ①				Box lug ①			
Wire size AWG min – max		16 – 8 ②				14 – 4 Cu/Al			
Tightening torque (recommended)		22 in. lbs.				40 in. lbs			
Coil termination		Dual .250 QC (2)				Dual .250 QC (2)			
Quick connects .250 std. 1 – 1.5 pole		Quad				Quad			
Quick connects .250 std. 2 pole		Dual or quad				Dual or quad			
Covers		Standard				Standard			
Insulation system		130° C Class B				130° C Class B			

30A – 60A – 3 pole

Coil technical data		DP30, DP40C3P				DP60C3P					
Nominal coil voltage		24	120	208/240	277	480	24	120	208/240	277	480
Maximum pickup volts		18	88	177	220	384	18	93	177	235	374
Drop-out volts range		6 – 15	20 – 70	40 – 140	65 – 185	150 – 270	6 – 15	20 – 70	40 – 135	50 – 180	150 – 286
Nominal inrush VA	50 Hz	65	65	65	65	65	140	140	140	140	140
Nominal inrush VA	60 Hz	60	60	60	60	60	132	132	132	132	132
Nominal sealed VA	50 Hz	7.5	7.5	7.5	7.5	7.5	20	20	20	20	20
Nominal sealed VA	60 Hz	6	6	6	6	6	14	14	14	14	14
Nominal DC resistance	Ohms	6.6	165	660	880	1320	2.4	45	180	280	852
Other specifications		DP30C3P				DP40C3P				DP60C3P	
Line and load terminals		# 10 – 32 Screw ①				Box lug ①				Box lug ①	
Wire size AWG min – max		16 – 8 ②				14 – 7 Cu/Al				14 – 2 Cu/Al	
Tightening torque (recommended)		22 in. lbs				40 in.lbs				50 in. lbs	
Quick connects: power terminals		Dual.250 QC				Dual.250 QC				Dual.250 QC	
Coil terminals		Dual .250 QC (2)				Dual .250 QC (2)				#6 – 35 screw & .250 QC (2)	
Covers		Standard				Standard				Standard	
Insulation system		130° C Class B				130° C Class B				130° C Class B	

30A – 40A – 4 Pole

Coil technical data		DP30, DP40C4P					
Nominal coil voltage		24	120	208/240	277	480	
Maximum pickup volts		19.2	88	177	220	384	
Drop-out volts range		6 – 15	20 – 70	40 – 140	65 – 185	150 – 270	
Nominal inrush VA	50 Hz	68	68	58	58	48	
Nominal inrush VA	60 Hz	60	60	55	52	52	
Nominal sealed VA	50 Hz	14	14	11	11	11	
Nominal sealed VA	60 Hz	9	9	9.5	9.5	9	
Nominal DC resistance	Ohms	5	148	550	750	2100	
Other specifications		DP30C4P				DP40C4P	
Line and load terminals		# 10 – 32 screw ①				Box Lug	
Wire size AWG Min – Max		16 – 8 ②				14 – 4 Cu/AL	
Tightening torque (recommended)		22 in. lbs				40 in. lbs	
Quick connects: power terminals		Dual .250 QC				Dual .250 QC	
Coil terminals		Dual .250 QC (2)				Dual .250 QC (2)	
Covers		Optional				Standard	
Insulation system		130° C Class B				130° C Class B	

① See page 1.82 to 1.85 for description and approximate dimensions.
 ② Stranding must be split for #8 wire.

Approximate dimensions

30A

1, 2 & 3 Pole

← 00.00 → Inches
00.00 → [Millimeters]

DP30C1P

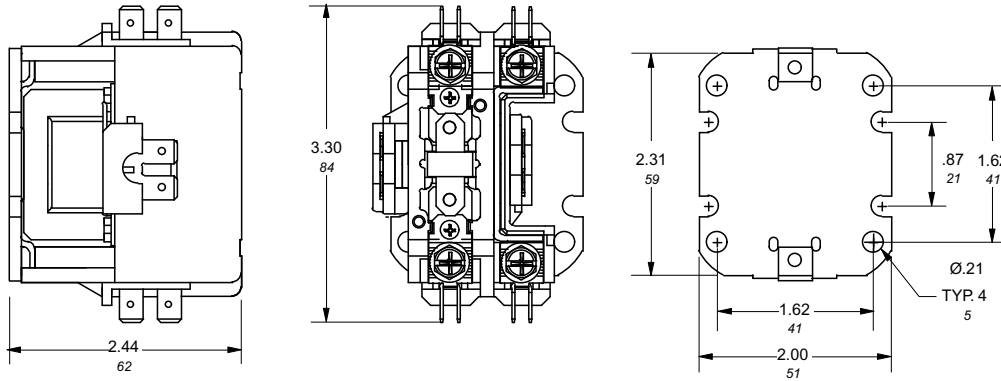

DP30C2P

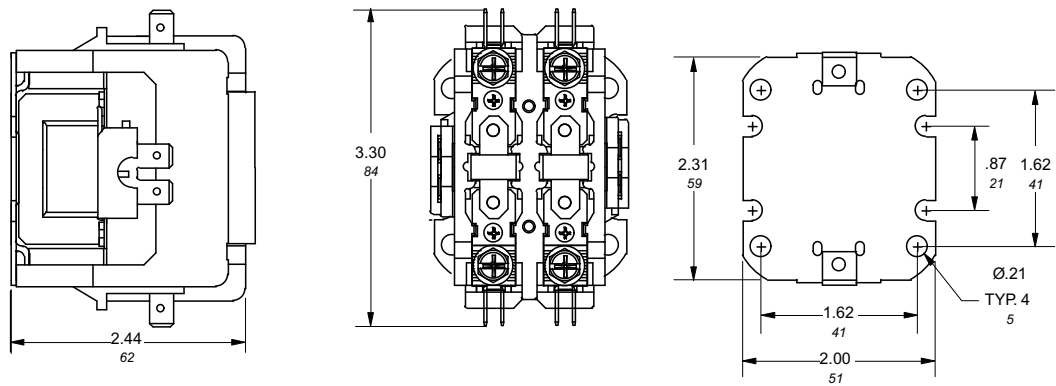

DP30C3P

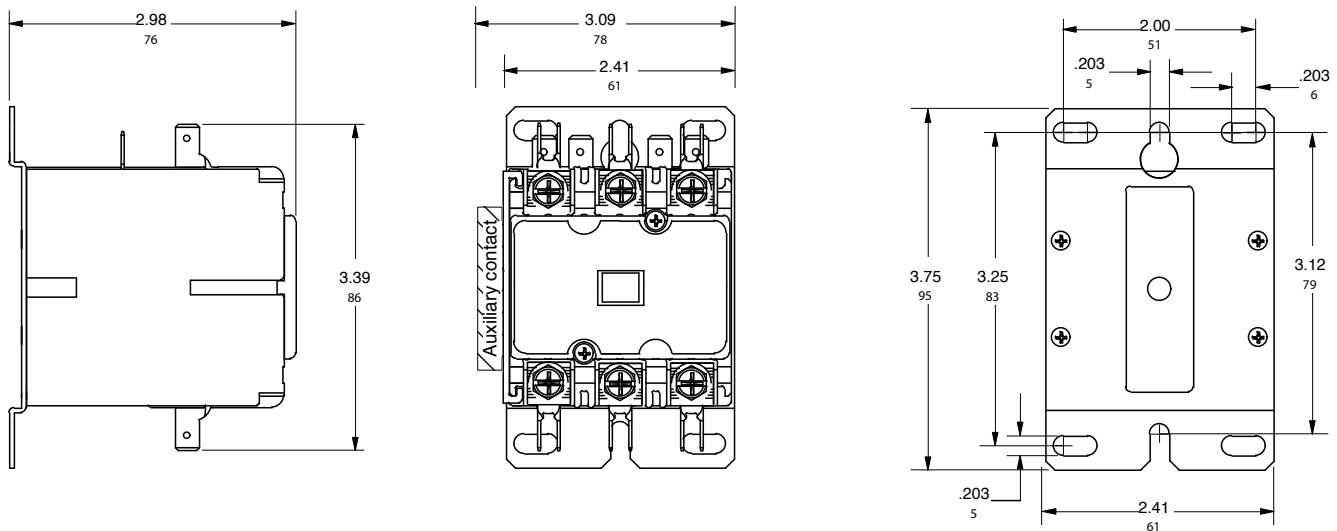

Approximate dimensions

30A 4 Pole
40A 2 & 3 Pole

00.00 Inches
00.00 [Millimeters]

DP30C4P

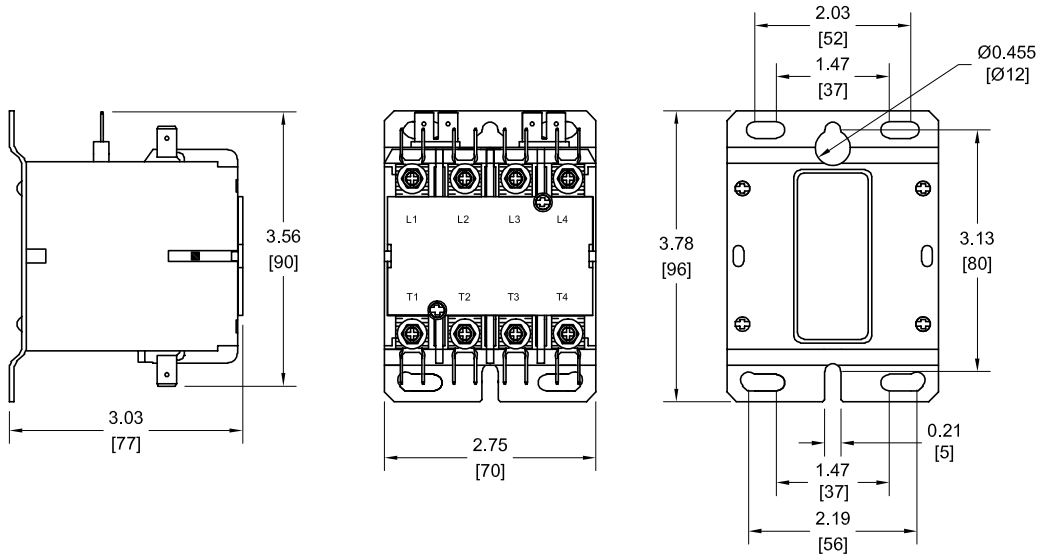

DP40C2P

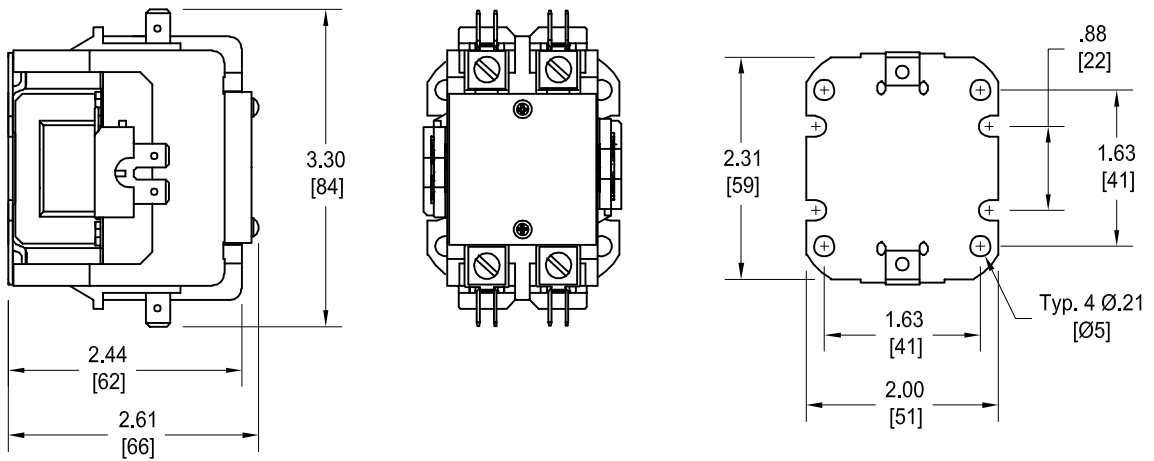

DP40C3P

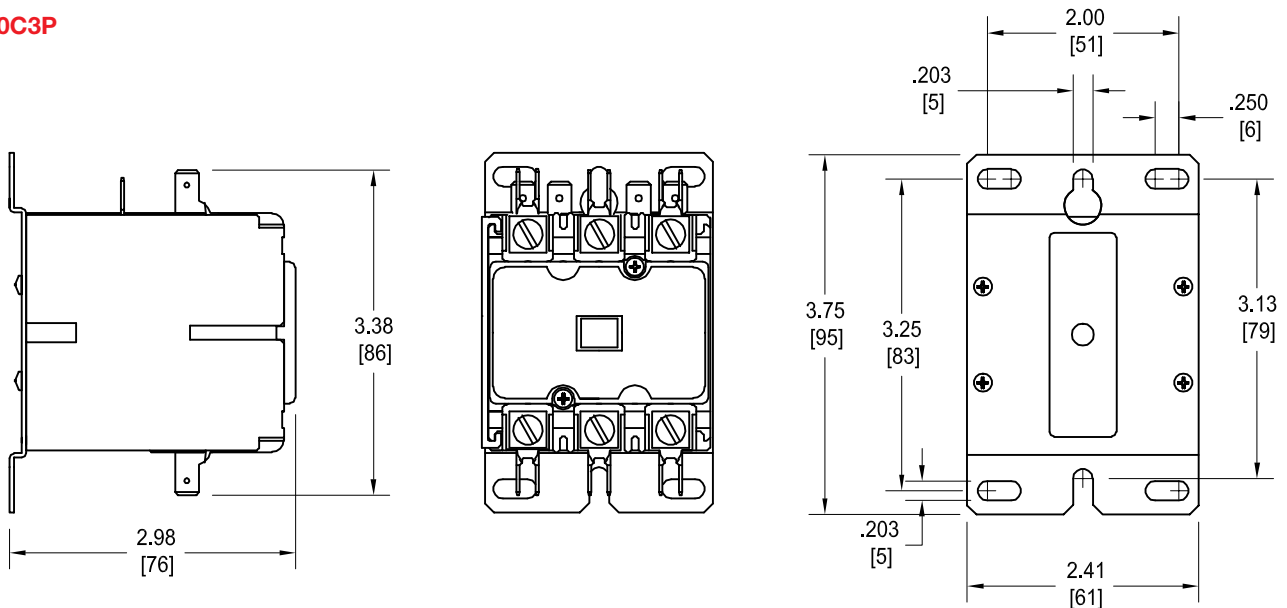

Approximate dimensions

40A 4 Pole
60A 3 Pole

DP40C4P

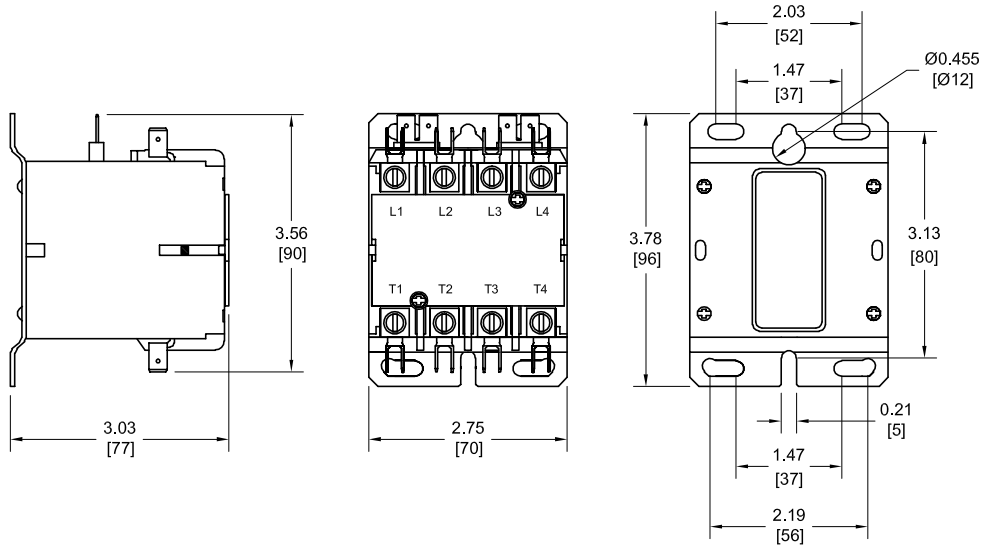

DP60C3P

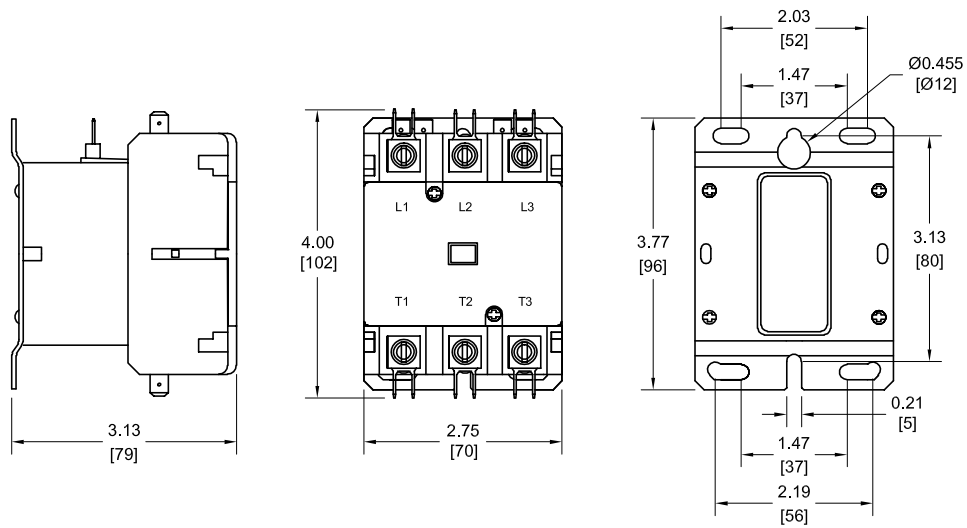

Approximate dimensions Terminations

Definite purpose
contactors

1

Screw

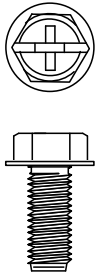

Standard on
DP30

10-32 Combination
Phillips, slotted &
5/16 Hex Head

Lugs

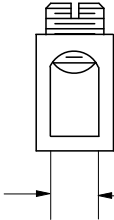

Standard on
DP40

14 - 4 AWG, Cu / Al

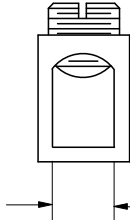

Standard on
DP60

14 - 2 AWG, Cu / Al

Notes



Drive contactors Type DA & EHDB

1

Drive Contactors

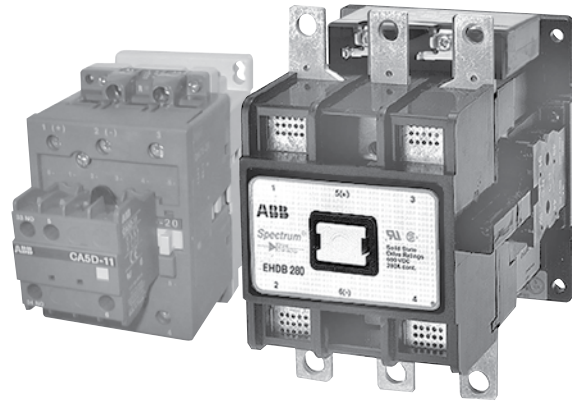

Description Type DA

- 60 amps size
- 500 volt DC ratings
- 160 and 300 volt DC normal closed ratings for dynamic braking
- Low energy auxiliary contacts available (17V, 5mA)
- Mechanically interlocked version available for reversing applications
- Small compact design
- 2 pole (2 N.O.) and 3 pole (2 N.O. & 1 N.C.) available
- Additional auxiliary contact blocks available
- Auxiliary contacts available to meet elevator standards
- Fast, snap-on DIN rail mounting
- Double break contact design
- Captive terminal screws
- Touch-safe design: all connection terminals are protected against accidental touch
- Terminals supplied open for ease of wiring
- Operates over an extended voltage range of 85% to 110% of rated control voltage
- N.C. dynamic braking pole is easily added to two pole contactors
- Screwdriver guide holes
- Snap-on front mounted accessories
- UL and CSA approved

Type EHDB

- 220 amps to 960 amps
- 2 pole (2 N.O.) and 3 pole (2 N.O. & 1 N.C.) power poles available
- 600 VDC making capacity:
300 VDC breaking capacity
- 1 N.O. & 1 N.C. auxiliary contacts are standard and up to six additional auxiliary contacts may be added to provide a total of 8 (4 N.O. & 4 N.C.)
- Early make & late break auxiliary contacts available
- Auxiliary contacts available to meet elevator standards
- EHDB 220, 280 & 360 contactors have withdrawable coils
- Mechanically interlocked contactors available for reversing applications
- Double break contact design with magnetic arc chamber extinguishes arc in shortest possible time
- High temperature encapsulated coil
- Easy removal of arc chute for quick inspection and change of contacts
- Operates over an extended voltage range of 85% to 110% of rated control voltage
- DC control operation available
- UL & CSA approved
UL File # E36588
CSA File # LR19700

Type DA 60 Amps



DA75-21A-11-84

2 & 3 pole — 500 volt N.O. ratings with 160 volt N.C. dynamic braking rating

Thermal amp rating	Maximum amp rating N.C. contact		Auxiliary contacts included		2 pole (2 N.O.)		3 pole (2 N.O. & 1 N.C.)	
	Make 300 VDC	Break 160 VDC	N.O.	N.C.	Catalog number	List price	Catalog number	List price
60	90	55	2 1	1 1	— DA75-20-11-84	— \$ 620	DA75-21-21-84 —	\$ 770 —

3 pole — 500 volt N.O. ratings with 300 volt N.C. dynamic braking rating

Thermal amp rating	Maximum amp rating N.C. contact		Auxiliary contacts included		3 pole (2 N.O. & 1 N.C.)	
	Make 500 VDC	Break 300 VDC	N.O.	N.C.	Catalog number	List price
60	90	55	1	1	DA75-21A-11-84	\$ 860

NOTE: DA75 2 & 3 pole contactors are equipped with polarity-dependent N.O. contacts.

Description

DA drive contactors are specifically designed for use with solid state D.C. adjustable speed drive systems. In drive applications, the contactor is not required to make or break the load during normal operation. The N.C. contact is used for dynamic braking applications.

Coil voltage selection

All DC operated catalog numbers include a 24VDC coil. To select other coil voltages, substitute the code from the Coil Voltage Selection Chart for the two digits after the last dash in the catalog number.

Ex.: A 24V coil is required for an DA75 contactor: DA75-20-11-81

Coil voltage selection chart

Hz	Cntr type	Volts															
		12	24	48	110	120	125	208	220	240	277	380	415	440	480	500	600
60	A		81	83	84	84		34	36	80	42		86	86	51	53	55
50	A		81	83	84							85	86				55

NOTE: DC coils are available for DA75 contactors only. For other voltages, see page 1.26.

Additional auxiliary contacts

Contactor number	Number of auxiliary contacts that may be added to DA contactors
DA75-21-21-84	(1 – 2) CA5 & (1) CAL5 Aux
DA75-20-11-84	(1) DB Adder deck & (2) CA5 & (1) CAL5 Aux

Auxiliary contact block adders

Top mounted for DA9 – DA75	Catalog number	List price
N.O.	CA5-10	\$ 15
N.C.	CA5-01	
1 N.O. & 1 N.C.	CAL5-11	30

All above auxiliary contact blocks fulfill the mirror contacts standards in IEC609 47-1 Annex F, Positive driven action IEC 609 47-1, Chapter 4. They also fulfill elevator standard ASME A17-1-2000.

Type EHDB 220 to 960 Amps



EHDB280C-1L



EHDB520C2P-1L

2 & 3 pole – 600 volt N.O. ratings with 300 volt N.C. dynamic braking rating

Thermal amp rating 600 volts	Maximum amp rating N.C. contact		Auxiliary contacts included		2 pole (2 N.O.)		3 pole (2 N.O. & 1 N.C.)	
	Make 300 VDC	Break 160 VDC	N.O.	N.C.	Catalog number	List price	Catalog number	List price
220	450	285	1	1	EHDB220C2P-1L	\$ 1,396	EHDB220C-1L	\$ 1,996
280	565	363	1	1	EHDB280C2P-1L	1,890	EHDB280C-1L	2,580
380	728	472	1	1	EHDB360C2P-1L	3,900	EHDB360C-1L	5,640
520	1040	680	1	1	EHDB520C2P-1L	4,500	EHDB520C-1L	6,750
650	1300	850	1	1	EHDB650C2P-1L	7,906	EHDB650C-1L	9,300
800	1600	1050	1	1	EHDB800C2P-1L	9,690	EHDB800C-1L	11,400
960	1920	1250	1	1	EHDB960C2P-1L	12,240	EHDB960C-1L	14,400

Description

EHDB drive contactors are specifically designed for use with solid state D.C. adjustable speed drive systems. In drive applications, the contactor is not required to make or break the load during normal operation. The N.C. contact is used for dynamic braking applications. EHDB contactors are provided less terminal lugs.

Coil voltage selection

All catalog numbers include a 120V coil. To select other coil voltages, substitute the code from the coil voltage selection chart for the first digit after the dash in the catalog number.

Coil voltage selection chart – EHDB contactors

		Volts														
		24	48	110	120	125	208	220	240	277	380	415	440	480	500	600
60	F	G		1		B	2	2	C				3	4		6
50	N		1			J				3	4				6	
DC	Y	W	P		Q	R										

NOTE: For other voltages, consult factory. • 24VAC coils are not available for sizes EHDB520 – EHDB960. • 48VAC coils are not available for sizes EHDB520 – EHDB960. For these 24V and 48V applications, use an interposing control relay. • 12VDC coils are not available for EHDB520 – EHDB960.

DC operated contactors

EHDB220 – EHDB960

DC and AC operated contactors have the same magnet structure except the DC coil includes a resistor and a normally closed late break auxiliary interlock. To order, substitute the code from the coil voltage selection chart and refer to the DC magnet coils chart for the price adder.

DC operated contactors are supplied with 2 N.O. & 1 N.C. auxiliary contacts. One additional 1 N.O. & 1 N.C. auxiliary contact block can be mounted on the left side of the contactor.

DC magnet coils (per contactor)

Contactor size	List price
EHDB220 – EHDB280	\$ 255
EHDB360	285
EHDB520	360
EHDB650 – EHDB960	495

Type DA & EHDB Mechanically interlocked 60 to 960 Amps

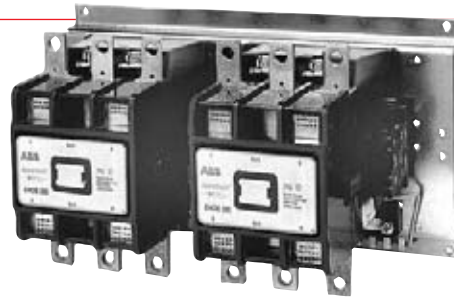

EHDB280M-1L

2 & 3 pole — 600 volt N.O. ratings with 300 volt N.C. dynamic braking rating

Thermal amp rating 500V (DA) 600V (EHDB)	Maximum amp rating N.C. contact		Auxiliary contacts included each contactor		2 pole (2 N.O.)		3 pole (2 N.O. & 1 N.C.)	
	Make	Break	3 Pole N.O.	2 Pole N.C.	Catalog number	List price	Catalog number	List price
60	90	55	1 NO & 1 NC	1 NO & 1 NC	DA75M-20-11-84	\$ 1,560	DA75M-21A-11-84	\$ 1,870
220	450	285	1 NO & 1 NC	1 NO & 1 NC	EHDB220M2P-1L	3,306	EHDB220M-1L	4,506
280	565	363	1 NO & 1 NC	1 NO & 1 NC	EHDB280M2P-1L	4,296	EHDB280M-1L	5,676
380	728	472	1 NO & 1 NC	1 NO & 1 NC	EHDB360M2P-1L	8,592	EHDB360M-1L	12,072
520	1040	680	1 NO & 1 NC	1 NO & 1 NC	EHDB520M2P-1L	9,972	EHDB520M-1L	14,472
650	1300	850	1 NO & 1 NC	1 NO & 1 NC	EHDB650M2P-1L	16,782	EHDB650M-1L	19,572
800	1600	1050	1 NO & 1 NC	1 NO & 1 NC	EHDB800M2P-1L	20,532	EHDB800M-1L	23,952
950	1920	1250	1 NO & 1 NC	1 NO & 1 NC	EHDB960M2P-1L	25,632	EHDB960M-1L	29,952

DA75 contactors are equipped with polarity dependent N.O. contacts. EHDB contactors are equipped with polarity dependent N.C. contacts.

Description

EHDB mechanically interlocked drive contactors are designed for reversing applications. The complete assembly consists of two mechanically and electrically interlocked contactors supplied without control and power wiring. The coil voltage selection

Coil voltage selection

Type DA

All DC operated catalog numbers include a 24VDC coil. To select other coil voltages, substitute the code from the Coil Voltage Selection Chart for the two digits after the last dash in the catalog number.

Ex.: A 24V coil is required for an DA75M contactor: DA75M-20-11-81

Type EHDB

All catalog numbers include a 120V coil. To select other coil voltages, substitute the code from the coil voltage selection chart for the first digit after the dash in the catalog number.

Ex.: A 220V coil is required for an EHDB960M contactor: EHDB960M2P-2L

Coil voltage selection chart – DA contactors

Hz	Cntr type	Volts															
		12	24	48	110	120	125	208	220	240	277	380	415	440	480	500	600
60	A		81	83	84	84		34	36	80	42		86	86	51	53	55
50	A		81	83	84				80			85	86			55	

NOTE: DC coils are available for DA75 contactors only.

For other voltages, see page 1.26.

Coil voltage selection chart – EHDB contactors

	Volts														
	24	48	110	120	125	208	220	240	277	380	415	440	480	500	600
60	F	G		1		B	2	2	C			3	4		6
50	N		1				J			3	4			6	
DC	Y	W	P		Q		R								

NOTE: For other voltages, consult factory. • 24VAC coils are not available for sizes EHDB520 – EHDB960. • 48VAC coils are not available for sizes EHDB520 – EHDB960. For these 24V and 48V applications, use an interposing control relay. • 12VDC coils are not available for EHDB520 – EHDB960.

DC magnet coils (per contactor)

Contactor size	List price
EHDB220M – EHDB280M	\$ 510
EHDB360M	570
EHDB520M	720
EHDB650M – EHDB960M	990

Replacement parts



Coils

Contactor type	Catalog number	AC coils List price
DA75	ZA75-Δ ①	\$ 57
EHD220, EHD280	EHDRC280-Δ	300
EHD350	EHDRC360-Δ	360
Withdrawable type	EHDRC280-Δ	390
EHD360	EHDRC360-Δ	360
EHD520, EHD650	EHDRC650-Δ	720
EHD800, EHD960	EHDRC960-Δ	870

Δ Substitute the Δ for a coil voltage suffix found in the Coil Voltage Selection Chart. EHDB coils can be used as replacement parts in EHD contactors.

Coil voltage selection chart – DA contactors ①

Hz	Ctr type	Volts															
		12	24	48	110	120	125	208	220	240	277	380	415	440	480	500	600
60	A		81	83	84	84		34	36	80	42		86	86	51	53	55
50	A		81	83	84				80				85	86		55	

NOTE: DC coils are available for DA75 contactors only.

Coil voltage selection chart – EHDB contactors

	Volts														
	24	48	110	120	125	208	220	240	277	380	415	440	480	500	600
60	F	G		1		B	2	2	C			3	4		6
50	N		1				J				3	4			6
DC	Y	W	P		Q		R								

NOTE: For other voltages, consult factory. • 24VAC coils are not available for sizes EHDB520 – EHDB960. • 48VAC coils are not available for sizes EHDB520 – EHDB960. For these 24V and 48V applications, use an interposing control relay. • 12VDC coils are not available for EHDB520 – EHDB960.

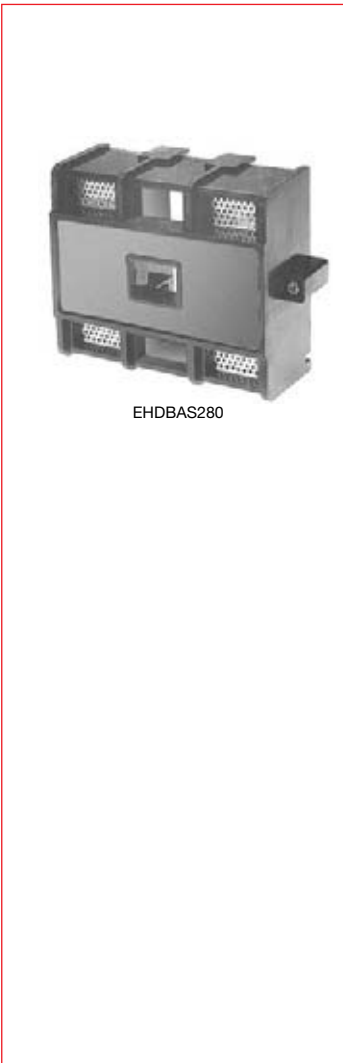

Arc shields

Contactor size	Catalog number	List price	
3 Pole	EHDB220	EHDBAS220	\$ 400
	EHDB280	EHDBAS280	466
	EHDB360	EHDBAS360	508
	EHDB520	EHDBAS520	610
	EHDB650	EHDBAS650	700
	EHDB800	EHDBAS800	742
	EHDB960	EHDBAS960	792
2 Pole	EHDB220	EHDBAS220-2	384
	EHDB280	EHDBAS280-2	442
	EHDB360	EHDBAS360-2	484
	EHDB520	EHDBAS520-2	586
	EHDB650	EHDBAS650-2	676
	EHDB800	EHDBAS800-2	714
	EHDB960	EHDBAS960-2	766

Auxiliary contact blocks – EHDB220 to EHDB960

Contactor sizes	Description	Terminal markings		Catalog number	List price
		N.O.	N.C.		
EHDB130 to EHDB960	Standard 1 N.O. & 1 N.C.	13, 14	21, 22	CAL16-11A	\$ 160
	Standard 1 N.O. & 1 N.C.	43, 44	31, 32	CAL16-11B	
	Standard 1 N.O. & 1 N.C.	53, 54	61, 62	CAL16-11C	
	Standard 1 N.O. & 1 N.C.	83, 84	71, 72	CAL16-11D	
	Late break 1 N.O. & 1 N.C.	47, 48	35, 36	CAL16-11E	

EHDB130 to EHDB960 contactors are provided with a 1 N.O. & 1 N.C. auxiliary contact block mounted on each contactor. One additional 1 N.O. & 1 N.C. auxiliary contact block can be mounted on the left side of the contactor and two additional 1 N.O. & 1 N.C. contact blocks can be mounted on the right side.

Positive driven action auxiliary contact blocks – EHDB220 to EHDB360

Contactor sizes	Description	Terminal markings		Catalog number	List price
		N.O.	N.C.		
EHDB220 to EHDB360	Standard 1 N.O. & 1 N.C. (left side)	13, 14	21, 22	CAL16-11N	\$ 160
	Standard 1 N.O. & 1 N.C. (right side)	43, 44	31, 32	CAL16-11P	

Only one of these auxiliary contact blocks can be mounted on each side of the contactor. They fulfill the mirror contacts IEC609 47-1 Annex F, positive driven action IEC609 47-1, Chapter 4. They also fulfill elevator standard ASME A17-1-2000.

① For other voltages, see page 1.26.

Replacement parts



EHDBCK280-2

Contact kits

Contactor size	Catalog number	List price
2 Pole, N.O.		
DA75	ZL75	\$ 158
EHDB220	EHDBCK220-2	600
EHDB280	EHDBCK280-2	720
EHDB360	EHDBCK360-2	1,396
EHDB520	EHDBCK520-2	2,052
EHDB650	EHDBCK650-2	2,736
EHDB800	EHDBCK800-2	3,376
EHDB960	EHDBCK960-2	4,230

N.C. DB Kit only

Contactor size	Contact rating	Auxiliary interlocks	Catalog number	List price
DA75	55A/160V; 28A/300V	1 NO	CA5D-11	\$ 120
DA75	300V	—	CA5D-01	150
EHDB220	300V	—	EHDBCK220-NC	330
EHDB280	300V	—	EHDBCK280-NC	330
EHDB360	300V	—	EHDBCK360-NC	630
EHDB520	300V	—	EHDBCK520-NC	1,026
EHDB650	300V	—	EHDBCK650-NC	1,026
EHDB800	300V	—	EHDBCK800-NC	1,380
EHDB960	300V	—	EHDBCK960-NC	1,380



EHDBCK280-NC

Lug kits

Contactor size	Wire size	Catalog number	List price
2 & 3 Pole			
EHDB220 – EHDB280	6-250	EHTK210	\$ 45
EHDB360 – EHDB650	4-500	EHTK550N	150
EHDB800	(2) 4-500	EHTK700	200
EHDB960	(3) 2-600	EHTK800	450

Technical data

Type DA

Contactor		DA75-21	DA75-21A
Main poles			
N.O. Poles, Amps @ 500VDC	A	60	60
240 VDC	HP	15	15
500 VDC	HP	30	30
Center pole			
N.C. Pole, 160V Make	Max. Amps	90	—
N.C. Pole, 160V Break	Max. Amps	55	—
N.C. Pole, 300V Make	Max. Amps	—	90
N.C. Pole, 300V Break	Max. Amps	—	55
DC rating			
Maximum thermal current	A	60	60
Peak interrupting current	A	90	90
Connectable wire size			
Main poles with lugs		8 – 1	8 – 1
Auxiliary contacts, min/max		18 – 10	18 – 10
Main contacts (contactor life)			
Mechanical endurance @ no load	mil.	5	5
Electrical endurance, main poles	mil.	1.5	1.5
Frequency of operations	per hour	600	600
Auxiliary contacts			
NEMA rating		A600	A600
AC rated voltage	V	600	600
AC thermal rated current	A	10	10
AC maximum making	VA	7200	7200
AC maximum breaking	VA	720	720
NEMA rating		P600	P600
DC rated voltage	V	600	600
DC thermal rated current	A	5	5
DC maximum make-break	A	0.2	0.2
Min. breakdown AC RMS voltage between live parts and ground	V	2200	2200
Minimum permissible load, 17V	A	0.005	0.005
Max. wire size on terminals @ 2/term		10 AWG	10 AWG
Max. operations per hour		600	600
Min. expected mechanical life	mil.	10	10
Min. expected electrical life	mil.	2	2
Coil operating data			
AC power consumption			
Inrush 60 Hz	VA	200	200
Holding 60 Hz	VA	20	20
Holding 60 Hz	W	5.5	5.5
AC operating time (in milliseconds)			
Closing time	ms	20 – 25	20 – 15
Opening time	ms	10 – 15	10 – 15
General data			
Approximate weight	lbs	2.4	2.4
Temperature limits			
Maximum operating temperature	°C	50	50
Minimum operating temperature	°C	-25	-25
Minimum storage temperature	°C	-40	-40
Maximum storage temperature	°C	70	70
Min. breakdown AC RMS voltage	V	2200	2200
Operating altitude			
Maximum operating altitude	feet	10,000	10,000

Technical data Type EHDB

Contactor model number		EHDB220	EHDB280	EHDB360	EHDB520	EHDB650	EHDB800	EHDB960
N.O. poles, Amps	600 VDC	220	280	360	520	650	800	960
N.C. pole, 600V Make	Max. amps	456	565	728	1040	1300	1600	1920
N.C. pole, 300V Break	Max. amps	285	363	472	680	850	1050	1250
Connectable wire size								
Main poles with lugs		8 – 30	5 – 250 kcmils	4 – 500 kcmils	(2) 4 – 500 kcmils	(2) 4 – 500 kcmils	(3) 2 – 600 kcmils	(3) 2 – 600 kcmils
Auxiliary contacts	min./max.	16/10	16/10	16/10	16/10	16/10	16/10	16/10
DC rating information								
	No. Poles							
Peak interrupting current	A	330	420	540	780	975	1200	1440
Maximum thermal current	A	220	280	360	520	650	800	960
Main contacts (contactor life)								
Mechanical endurance @ no load	mil.	5	5	5	5	5	5	5
Electrical endurance	mil.	1.5	1.5	1.5	1.5	1.5	1.5	1.5
Frequency of operations	per hour	300	300	300	300	300	300	300
Auxiliary contacts								
NEMA rating		A600	A600	A600	A600	A600	A600	A600
AC rated voltage	V	600	600	600	600	600	600	600
AC thermal rated current	A	10	10	10	10	10	10	10
AC maximum making	VA	7200	7200	7200	7200	7200	7200	7200
AC maximum breaking	VA	720	720	720	720	720	720	720
NEMA rating								
DC rated voltage	V	600	600	600	600	600	600	600
DC thermal rated current	A	5	5	5	5	5	5	5
DC maximum make-break	A	0.2	0.2	0.2	0.2	0.2	0.2	0.2
Min. breakdown AC RMS voltage between live parts and ground		2200	2200	2200	2200	2200	2200	2200
Min. permissible load, 17V	A	0.005	0.005	0.005	0.005	0.005	0.005	0.005
Expected mechanical life	mil.	5	5	5	5	5	5	5
Max. operations per hour		300	300	300	300	300	300	300
Coil operating data								
AC power consumption								
Inrush 60 Hz	VA	900	900	1200	2900	2900	400	4000
Holding 60 Hz	VA	52	52	65	105	105	140	140
Holding 60 Hz	W	18	18	22	44	44	60	60
DC power consumption								
Inrush	W	500	500	630	800	800	1100	1100
Holding	W	3.6	3.6	4	20	20	20	20
AC operating time								
Closing time	ms	20 – 30	20 – 30	20 – 30	30 – 50	30 – 50	30 – 50	30 – 50
Opening time	ms	7 – 15	7 – 15	7 – 15	10 – 20	10 – 20	10 – 20	10 – 20
DC operating time								
Closing time	ms	30 – 40	30 – 40	30 – 40	60 – 80	60 – 80	60 – 80	60 – 80
Opening time	ms	27 – 37	27 – 37	27 – 37	10 – 20	55 – 75	55 – 75	55 – 75
General data								
Approximate weight	lbs	9.2	9.2	13	27.3	27.3	37	38
Temperature limits								
Maximum operating temperature	°C	70	70	70	70	70	70	70
Minimum operating temperature	°C	-40	-40	-40	-40	-40	-40	-40
Minimum storage temperature	°C	-50	-50	-50	-50	-50	-50	-50
Maximum storage temperature	°C	70	70	70	70	70	70	70
Min. Breakdown AC RMS Voltage		2200	2200	2200	2200	2200	2200	2200
Operating altitude								
Maximum operating altitude	feet	10,000	10,000	10,000	10,000	10,000	10,000	10,000

Approximate dimensions Type DA, 2 & 3 pole

DA75

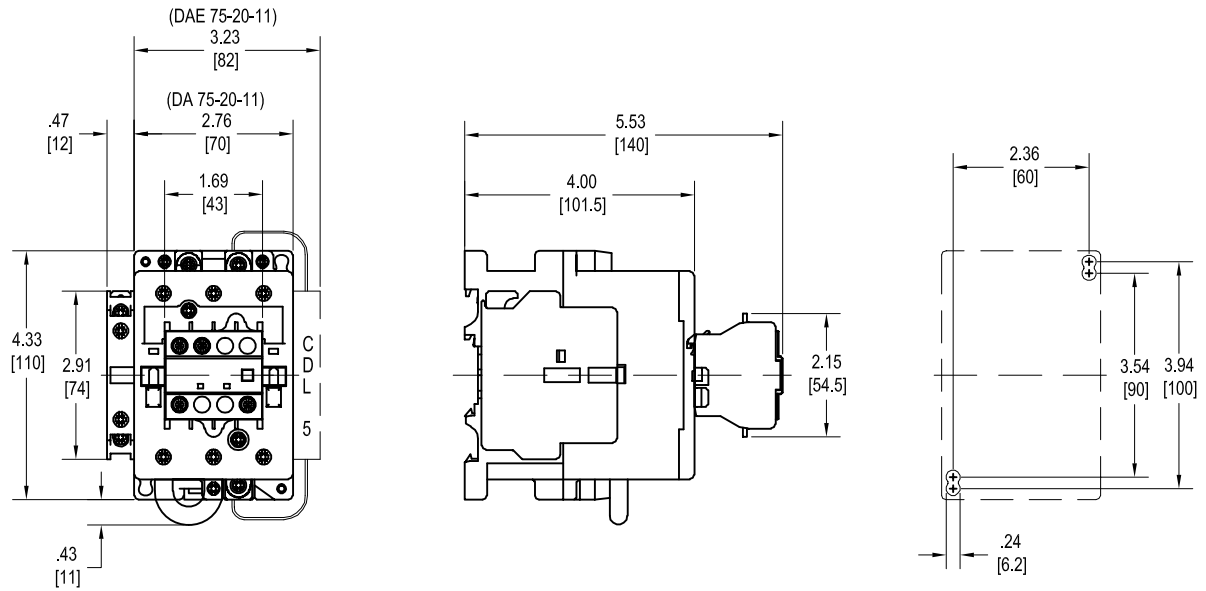

DA75M

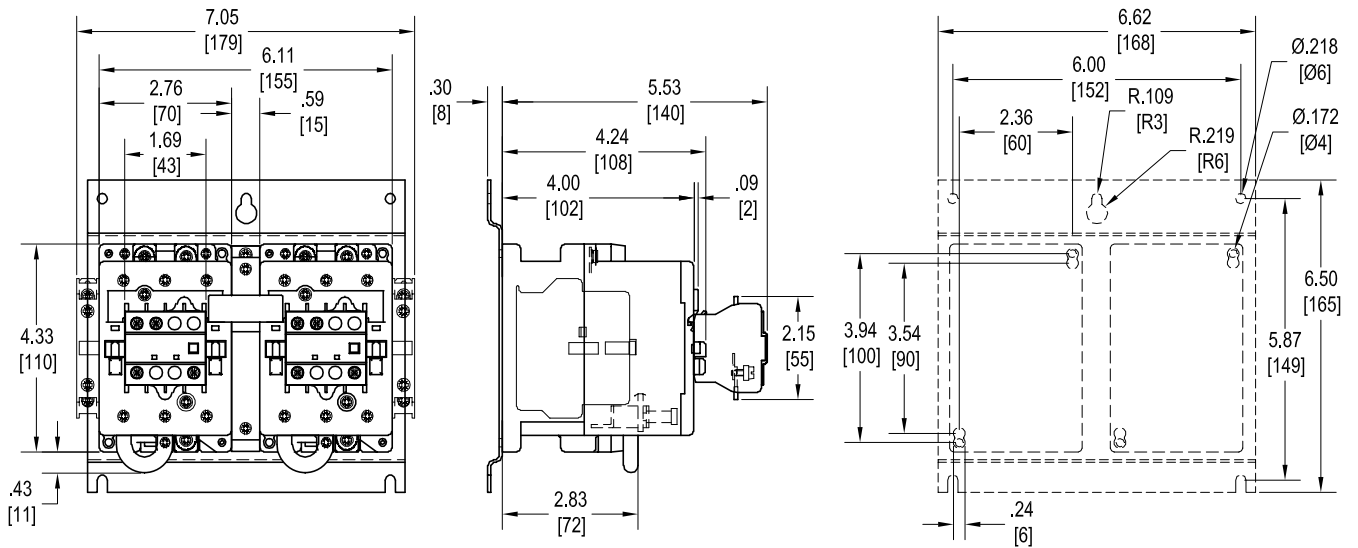

Approximate dimensions Type EHDB, 2 & 3 pole Mounting positions

EHDB220 – EHDB960

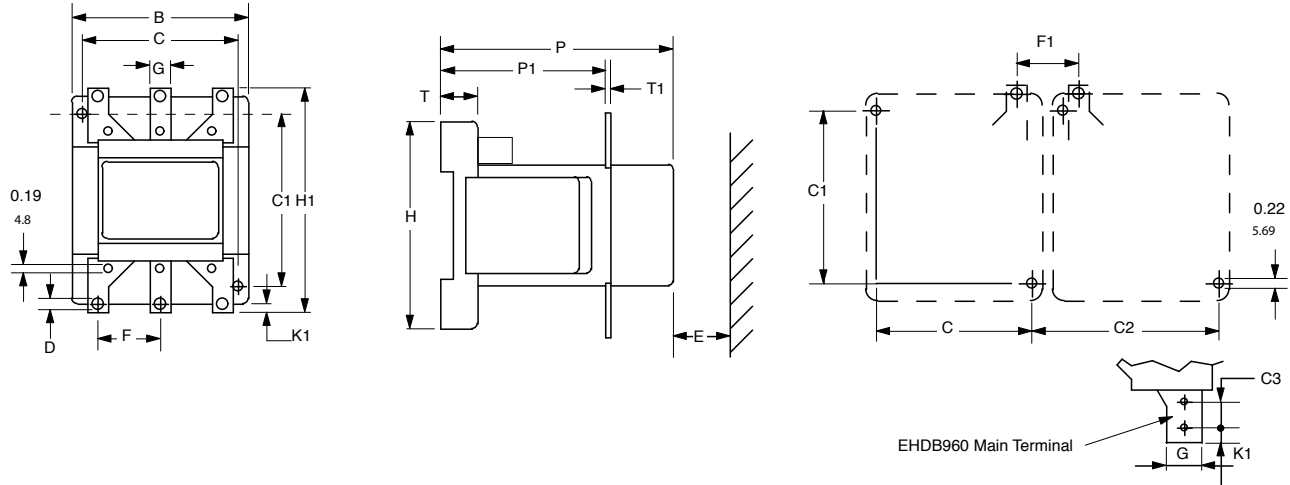

DIM.	B			C	C1	C2				E	D	F	G	H	H1	K1	P	P1	T	T1	C3	
	1, 2	3	4			①	②	③	④													
	Aux. contact block																					
EHDB220in	5.35	5.83	6.30	6.46	4.72	5.51	5.39	5.39	5.87	6.34	0.59	0.24	1.77	0.79	6.14	7.79	0.39	6.65	4.06	0.41	0.20	—
mm	136	148	160	164	120	140	137	137	149	161	15	6	45	20	156	198	10	169	103	10.5	5	—
EHDB280in	5.35	5.83	6.30	6.46	4.72	5.51	5.39	5.39	5.87	6.34	0.59	0.24	1.77	0.79	6.14	7.79	0.39	6.65	4.06	0.41	0.20	—
mm	136	148	160	164	120	140	137	137	149	161	15	6	45	20	156	198	10	169	103	10.5	5	—
EHDB360in	6.92	7.44	7.72	8.11	6.30	5.51	7.20	7.32	7.48	7.76	1.18	0.24	2.44	0.98	6.14	8.14	0.49	6.88	4.21	0.7	0.20	—
mm	176	189	196	206	160	140	183	186	190	197	30	6	62	25	156	207	12.5	175	107	19	5	—
EHDB520in	7.80	8.23	8.62	8.90	6.69	7.87	7.91	7.91	8.19	8.54	1.57	0.24	2.64	0.98	8.78	10.71	0.49	8.90	5.51	0.9	0.24	—
mm	198	209	219	226	170	200	201	201	208	217	40	6	67	25	223	272	12.5	226	140	23	6	—
EHDB650in	7.80	8.23	8.62	8.90	6.69	7.87	7.91	7.91	8.19	8.54	1.57	0.24	2.64	0.98	8.78	10.71	0.49	8.90	5.51	0.9	0.24	—
mm	198	209	219	226	170	200	201	201	208	217	40	6	67	25	223	272	12.5	226	140	23	6	—
EHDB800in	9.61	9.96	10.31	10.63	8.66	7.87	9.69	9.690	10.00	10.35	1.57	0.24	3.23	1.57	8.78	11.57	0.79	8.90	5.51	0.9	0.24	—
mm	244	253	262	270	220	200	246	246	254	263	40	6	82	40	223	294	20	226	140	23	6	—
EHDB960in	9.61	9.96	10.31	10.63	8.66	7.87	9.69	9.690	10.00	10.35	1.57	0.24	3.23	1.57	8.78	11.57	0.79	8.90	5.51	0.9	0.24	1.36
mm	244	253	262	270	220	200	246	246	254	263	40	6	82	40	223	294	20	226	140	23	6	34.5

- ① Minimum dimension
 - ② Makes distance F1 = F
 - ③ Includes space for three auxiliary contact blocks between the contactors.
 - ④ Includes space for four auxiliary contact blocks between the contactors.
 - ⑤ Damping elements are included.
- NOTE: Screw, nut and washer are included for terminal hardware.

Type DA & EHDB mounting positions

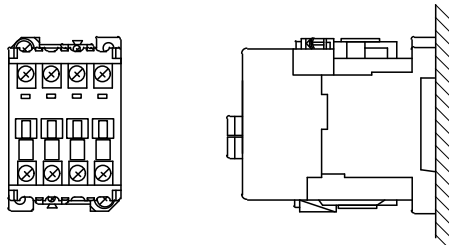

Lighting Contactors



Lighting contactors A9 – A300

1

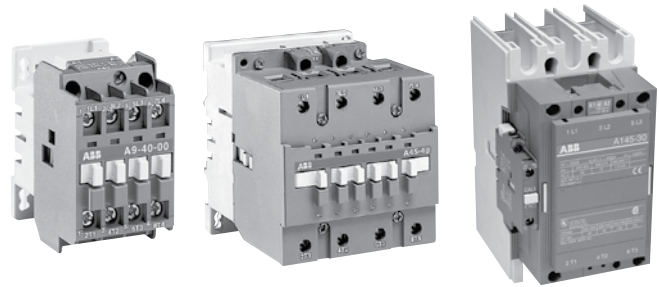

Features

- CE mark
- Compact space saving design
- Standard auxiliary contact configurations:
 - A9 - A40 1 NO or 1 NC
 - A50 - A110 1 NO & 1 NC
- Additional auxiliary contact blocks are available
- Panel mounting with screws or fast, snap-on DIN rail mounting
- Silver alloy double break contact design
- Snap-on front mounted accessories include mechanical latch, pneumatic timer, and 1 & 4 pole auxiliary contact blocks
- Contactors ensure positive safety between their auxiliary contact blocks.
- Easy coil change
- Captive terminal screws
- NEMA, UL, IEC, CSA, VDE and most other international standards
- Touch safe design: All connection terminals are protected against accidental touch
- Terminals supplied open for ease of wiring
- Operates over an extended voltage range of 85% to 110% of rated control voltage
- Screwdriver guide holes
- UL File No: E39231 (A9 - A75); (AE9 - AE75); (AL9 - AL40); (AF50 - AF75)
- UL File No: E36588 (A95 - A110); (AE95 - AE110); (AF145 - AF750)
- CSA File No: LR56745 (A9 - A75); (AE9 - AE75); (AF50 - AF75)
- CSA File No: LR19700 (A95 - A110); (AE95 - AE110); (AF145 - AF750)

Applications

Lighting contactors can be used to control a variety of lighting loads including:

- Tungsten filament lighting loads (incandescent), iodine lamps, quartz-iodine and infrared lamps
- Electric discharge lighting loads (ballast), high intensity discharge (HID), mercury vapor, metal halide and high pressure sodium and fluorescent lamps

Typical applications

- Parking lots
- Industrial plants
- Office buildings
- Theaters and auditoriums
- Stadiums
- Shopping centers
- Airports
- Hospitals
- Transportation lighting
- Institutions

Description

The A-Line lighting contactors are available with or without an enclosure.

- Maximum operating voltage of 600VAC 60Hz
- Includes 3, 4, 8 or 12 pole versions, other versions on request
- Electrically or mechanically held contactors
- IP 20 protection for connection terminals
- Can be mounted onto a mounting plate or a 35 x 7.5mm DIN rail
- UL/CSA Approved

A9 - A300

Electrically & mechanically held



A9-40-00

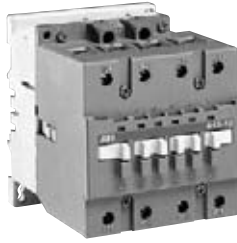

A45-40-00



A145-30-11

Normally Open Power Poles			Electrically Held					Mechanically Held				
Ballast Amp Rating	Incandescent (Tungsten) Amp Rating	Number of Power Poles	Open Type		UL Type 1 Enclosed			Open Type		UL Type 1 Enclosed		
			Catalog number	List price	Enclosure Size	Catalog number	List price	Catalog number	List price	Enclosure Size	Catalog number	List price
15	15	4	A9-40-00-84	\$ 120	A	A9C4P1-84	\$ 175	A9L-40-00-84	\$ 214	B	A9LC4P1-84	\$ 269
15	15	8	A9-80-00-84	272	A	A9C8P1-84	327	A9L-80-00-84	460	B	A9LC8P1-84	515
15	15	12	A9-120-00-84	392	A	A9C12P1-84	447	A9L-120-00-84	674	B	A9LC12P1-84	729
30	20	4	A16-40-00-84	165	A	A16C4P1-84	220	A16L-40-00-84	259	B	A16LC4P1-84	314
30	20	8	A16-80-00-84	362	A	A16C8P1-84	417	A16L-80-00-84	550	B	A16LC8P1-84	605
30	20	12	A16-120-00-84	527	A	A16C12P1-84	582	A16L-120-00-84	809	B	A16LC12P1-84	864
30	30	4	A16-40L-00-84	175	A	A16C4PL1-84	230	A16L-40L-00-84	269	B	A16LC4PL1-84	324
30	30	8	A16-80L-00-84	372	A	A16C8PL1-84	427	A16L-80L-00-84	560	B	A16LC8PL1-84	615
30	30	12	A16-120L-00-84	537	A	A16C12PL1-84	592	A16L-120L-00-84	819	B	A16LC12PL1-84	874
35	35	4	A26-40-00-84	228	B	A26C4P1-84	283	A26L-40-00-84	322	B	A26LC4P1-84	409
35	35	8	A26-80-00-84	488	B	A26C8P1-84	543	A26L-80-00-84	676	B	A26LC8P1-84	764
35	35	12	A26-120-00-84	716	B	A26C12P1-84	803	A26L-120-00-84	998	B	A26LC12P1-84	1,085
50	50	3	A30-30-10-84	252	B	A30C3P1-84	328	A30L-30-10-84	346	C	A30LC3P1-84	522
60	60	3	A40-30-10-84	297	B	A40C3P1-84	373	A40L-30-10-84	391	C	A40LC3P1-84	567
60	60	4	A45-40-00-84	360	B	A45C4P1-84	536	A45L-40-00-84	454	C	A45LC4P1-84	730
65	65	3	A50-30-00-84	300	B	A50C3P1-84	424	A50L-30-00-84	394	C	A50LC3P1-84	618
65	65	4	A50-40-00-84	413	B	A50C4P1-84	568	A50L-40-00-84	507	C	A50LC4P1-84	772
85	85	3	A63-30-00-84	342	B	A63C3P1-84	502	A63L-30-00-84	436	C	A63LC3P1-84	696
105	105	3	A75-30-00-84	383	B	A75C3P1-84	576	A75L-30-00-84	477	C	A75LC3P1-84	770
105	105	4	A75-40-00-84	525	B	A75C4P1-84	672	A75L-40-00-84	619	C	A75LC4P1-84	866
120	120	3	A95-30-00-84	420	B	A95C3P1-84	720	---	---	---	---	---
200	200	3	A145-30-00-84	785	E	A145C3P1-84	1,336	---	---	---	---	---
300	300	3	A210-30-00-84	1,595	F	A210C3P1-84	3,624	---	---	---	---	---
400	400	3	A300-30-00-84	1,835	F	A300C3P1-84	3,864	---	---	---	---	---

Normally Closed Power Poles			Electrically Held					Mechanically Held				
Ballast Amp Rating	Incandescent (Tungsten) Amp Rating	Number of Power Poles	Open Type		UL Type 1 Enclosed			Open Type		UL Type 1 Enclosed		
			Catalog number	List price	Enclosure Size	Catalog number	List price	Catalog number	List price	Enclosure Size	Catalog number	List price
30	20	4	A16-04-00-84	\$ 165	B	A16C4NCP1-84	\$ 220	A16L-04-00-84	\$ 259	B	A16LC4NCP1-84	\$ 314
30	20	8	A16-08-00-84	362	B	A16C8NCP1-84	417	A16L-08-00-84	550	B	A16LC8NCP1-84	605
30	20	12	A16-012-00-84	527	B	A16C12NCP1-84	582	A16L-012-00-84	809	B	A16LC12NCP1-84	864

Coil voltage selection

All catalog numbers include a 120VAC coil. To select other coil voltages, substitute the code from the Coil Voltage Selection Chart for the two digits after the last dash in the catalog number.

Ex.: A 240V coil is required for an A75 contactor: A75-30-00-80

Coil voltage selection

Hz	Cntr Type	Volts															
		12	24	48	110	120	125	208	220	240	277	380	415	440	480	500	600
60	A		81	83	84	84		34	36	80	42		86	86	51	53	55
50	A		81	83	84				80			85	86			55	

For other voltages, consult factory

Control transformer option

Contacteur size	VA rating	List price adder
A9 - A40	50	\$ 360
A50 - A75	75	435
A95	100	560
A145	150	720
A210 - A300	250	795

Control transformer voltage selection chart

Hz	Type	Volts			
		208/120	230 - 240/120	460 - 480/120	575 - 600/120
50/60	A	0	7	8	9

For other voltages, consult factory

A9 - A300

Electrically & mechanically held

2 Normally Open & 2 Normally Closed Power Poles			Electrically Held					Mechanically Held				
			Open Type		UL Type 1 Enclosed			Open Type		UL Type 1 Enclosed		
Ballast Amp Rating	Incandescent (Tungsten) Amp Rating	Number of Power Poles	Catalog number	List price	Enclosure Size	Catalog number	List price	Catalog number	List price	Enclosure Size	Catalog number	List price
15	15	2NO/2NC	A9-22-00-84	\$ 120	A	A9C22P1-84	\$ 175	A9L-22-00-84	\$ 214	A	A9LC22P1-84	\$ 269
30	20	2NO/2NC	A16-22-00-84	165	B	A16C22P1-84	220	A16L-22-00-84	259	B	A16LC22P1-84	314
35	35	2NO/2NC	A26-22-00-84	228	B	A26C22P1-84	283	A26L-22-00-84	259	B	A26LC22P1-84	409
60	60	2NO/2NC	A45-22-00-84	360	B	A45C22CP1-84	536	A45L-22-00-84	454	C	A45LC22CP1-84	730
105	105	2NO/2NC	A75-22-00-84	525	B	A75C22CP1-84	672	A75L-22-00-84	619	C	A75LC22CP1-84	866

NEMA rated

Normally open Power Poles 600 VAC Max.			Electrically held Open type	
Ballast Amp Rating	Incandescent (Tungsten) Amp rating	Number of Power poles 1	Catalog number	List price
30	30	3	L30A3010Δ	\$ 189
60	60	3	L60A3010Δ	297
100	100	3	L100A3000Δ	389
200	200	3	L200A3000Δ	785

Control transformer option

Contactor size	VA rating	List price adder
A9 - A40	50	\$ 360
A50 - A75	75	435
A95	100	560
A145	150	720
A210 - A300	250	795

Control transformer voltage selection chart

		Volts			
Hz	Type	208/120	230 - 240/120	460 - 480/120	575 - 600/120
50/60	A	0	7	8	9

For other voltages, consult factory

Coil voltage selection

All catalog numbers include a 120VAC coil. To select other coil voltages, substitute the code from the Coil Voltage Selection Chart for the two digits after the last dash in the catalog number.

Ex.: A 240V coil is required for an A75 contactor: A75-30-00-80

Coil voltage selection

Hz	Cntr Type	Volts															
		12	24	48	110	120	125	208	220	240	277	380	415	440	480	500	600
60	A		81	83	84	84		34	36	80	42		86	86	51	53	55
50	A		81	83	84				80			85	86			55	

For other voltages, consult factory

Accessories Factory modifications



CAL5-11

CA5-10



WB75-01



RV5/50

Accessories

Auxiliary contact blocks

Mounting on contactors	Positioning	Contacts	Catalog number	List price
A 9 ... A 95	Front face	1 - - 1	CA5-10 CA5-01	\$ 15
A 9 ... A 40	Front face	3 1 2 2	CA5-31M CA5-22M	
A 9 ... A 75	Side	1 1	CAL5-11	30
A 95 ... A 300	Side	1 1	CAL18-11	
A145... A 300	Side	1 1	CAL18-11B	

Mechanical latch

For contactors	Voltage	Catalog number	List price
A 9 ... A 75	24 ... 28 V a.c./d.c.	WB75A-01	\$ 84
	48 ... 55 V a.c./d.c.	WB75A-03	
	110 ... 127V a.c./d.c.	WB75A-04	
	230 ... 277 V a.c./d.c.	WB75A-05	
	380 ... 440 V a.c./d.c.	WB75A-07	
	440 ... 480 V a.c./d.c.	WB75A-08	

Surge suppressor, varistor

For contactors	Voltage range	Catalog number	List price
A 9 ... A 110	24 ... 50 V a.c./d.c.	RV5/50	\$ 30
	50 ... 133 V a.c./d.c.	RV5/133	
	110 ... 250 V a.c./d.c.	RV5/250	
	250 ... 440 V a.c./d.c.	RV5/440	

Factory modifications for enclosed contactors

Pilot devices

Description	Suffix code	List price
Selector - 2 position maintained OFF - ON	C	\$ 72
Selector - 3 position maintained HAND OFF - AUTO	D	72
Pilot light - ON (green)	R	135

Approximate dimensions

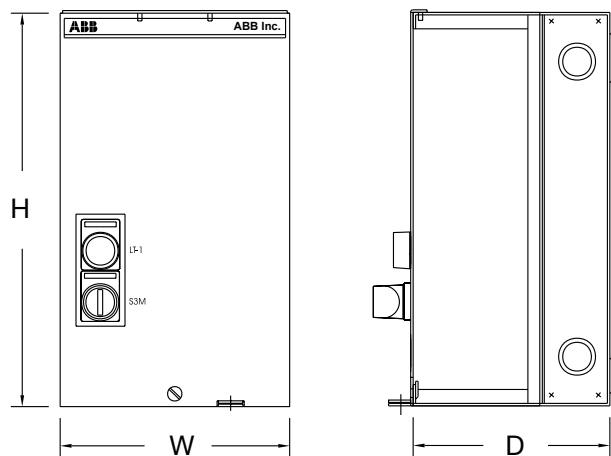

Enclosure dimensions (in)

Type	H	W	D
A	11	6	5
B	13	9	7
C	14	12	8
D	24	12	8
E	30	24	9



Welding isolation Contactors

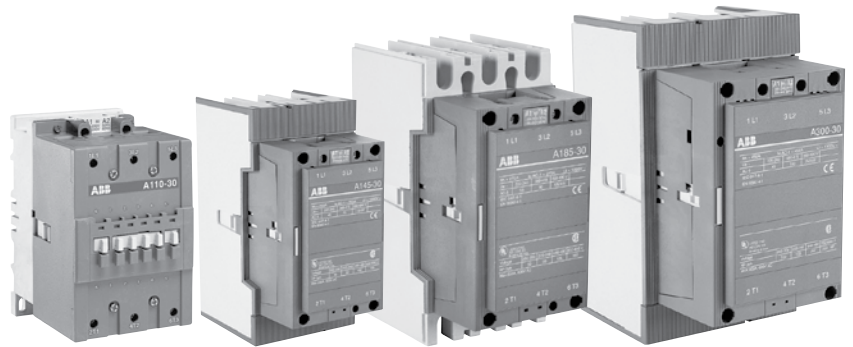

Applications

ABB welding isolation contactors are suited to the rugged demands set forth by the automotive industry and are specifically designed for use in high current welding applications. ABB is the leading contactor supplier for automotive welding applications.

Features

- Includes sizes:
 - W3 thru W6 in 3 pole configurations
 - W4 thru W5 in 2 pole configurations
 - Unique contact design assures reliable and safe operation during high current welding cycles
 - 1 N.O. & 1 N.C. auxiliary contacts are standard and up to 6 additional auxiliary contacts may be added to provide a total of 8 (4 N.O. & 4 N.C.)
 - Easy front removal of arc chute for quick inspection and change of contacts
 - Operates over an extended voltage range of 85% to 110% of rated control voltage
 - UL Listed, File # E36588
 - CSA Certified, File # LR19700
- AW welding isolation contactors can save substantial space compared to other conventional contactors.

140A – 600A 2 & 3 Pole



A110W



A300W



AF460W

3-Pole, A.C.

Size	Amp rating	Catalog number	List price
W3	140	A110W-30-11-84	\$ 480
—	200	A145W-30-11-84	825
W4	250	A185W-30-11-84	1,290
—	300	A210W-30-11-84	1,635
W5	350	A260W-30-11-84	1,815
—	400	A300W-30-11-84	1,875
W6	600	AF460W-30-11-70	4,425

2-Pole, A.C.

Size	Amp rating	Catalog number	List price
W3	140	—	—
—	200	A145W-20-11-84	\$ 750
W4	250	A185W-20-11-84	1,180
—	300	A210W-20-11-84	1,500
W5	350	A260W-20-11-84	1,675
—	400	A300W-20-11-84	1,750
W6	600	—	—

Coil voltage selection – wide range AC/DC coils for AF contactors

All AC operated catalog numbers include a 100-250 V AC/DC coil. To select other coil voltages, substitute the code from the Coil Voltage Selection Chart for the two digits after the last dash in the catalog number.

Ex.: A 24V coil is required for a AF460W contactor: AF460W-30-11-**68**

Coil voltage selection – A contactors

All AC operated catalog numbers include a 120VAC coil. To select other coil voltages, substitute the code from the Coil Voltage Selection Chart for the two digits after the last dash in the catalog number.

Ex.: A 240V coil is required for an A75 contactor: A75-30-11-**80**

Auxiliary contact blocks

For additional auxiliary contact blocks, see catalog number explanation on page 1.2. Add \$ 20 to list price for each additional auxiliary, and see page 1.18 for available combinations.

Vertical connection bars between 2 pole contactor and MCCB – two bars

MCCB	For contactor	Catalog number	List price
S3, S4	A145W-20 – A185W-20	BEA185-20D/S3S4	\$ 50
S3,S4	A210W-20 – A300W-20	BEA210-20D/S4	55
S5	A210W-20 – A300W-20	BEA300-20D/S5	60

For other accessories, see page 1.16 to 1.35.

Coil voltage selection chart – A contactors

Hz	Cntr type	Volts															
		12	24	48	110	120	125	208	220	240	277	380	415	440	480	500	600
60	A		81	83	84	84		34	36	80	42		86	86	51	53	55
50	A		81	83	84				80				85	86			55

For other voltages, see page 1.26.

Coil voltage selection – AF50 to AF750

AC/DC VOLTS, 40 - 60 HZ			
24 - 60 DC	20 - 60 DC	48 - 130 AC/DC	100 - 250 AC/DC
68 ①	72 ②	69	70

① AF400 – AF750, DC only.
② AF50 – AF300, DC only.

Technical data

Frame size	A110W	A145W	A185W	A210W	A260W	A300W	AF460W
Amp rating, 50°C	140	200	250	300	350	400	600
Making capacity, 600 VAC	1320	1740	2220	2520	3120	3360	4550
Breaking capacity, 480 VAC	880	1160	1480	1680	2080	2240	4180
Withstand current							
RMS	2500	2700	2900	3200	3600	4100	5800
Peak	3500	3900	4100	4600	5200	5900	8816
Short time current							
1 second	1320	1800	2000	2500	3100	3500	4600
10 seconds	800	1200	1500	1700	2100	2400	4400
30 seconds	500	800	1000	1200	1300	1500	3100
1 minute	350	600	800	1000	1000	1100	2500
15 minute	175	280	320	400	450	500	840
Coil operating data							
A.C. power consumption							
Inrush 60 Hz, VA	450	600	600	1350	1350	1350	800
Holding 60 Hz, VA	27	40	40	65	65	65	40
Holding 60 Hz, W	8	12	12	19	19	19	4.5
Maximum short circuit ratings							
MCCB	kA @ 480VAC	85	85	85	85	85	84
	kA @ 600VAC	35	35	35	35	35	42
Class J fuses	kA @ 600VAC	200	200	200	200	200	–

Approximate dimensions A110W – A300W

00.00 Inches
00.00 [Millimeters]

A110W

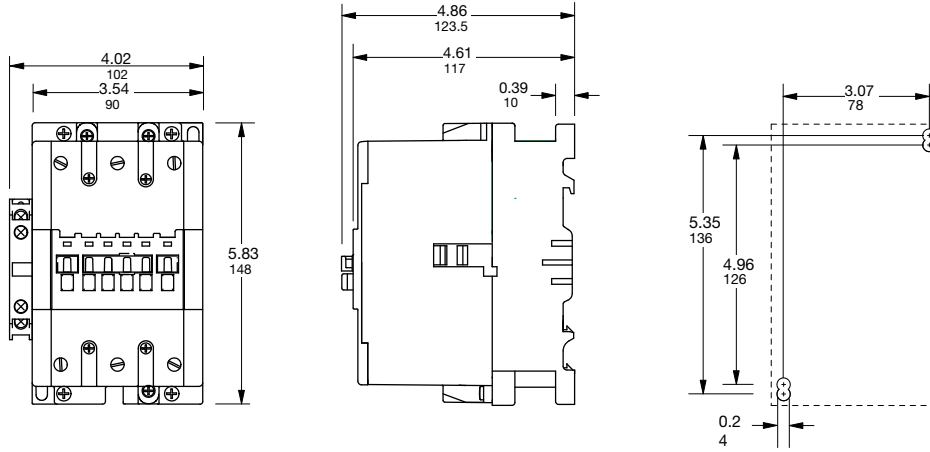

A145W, A185W

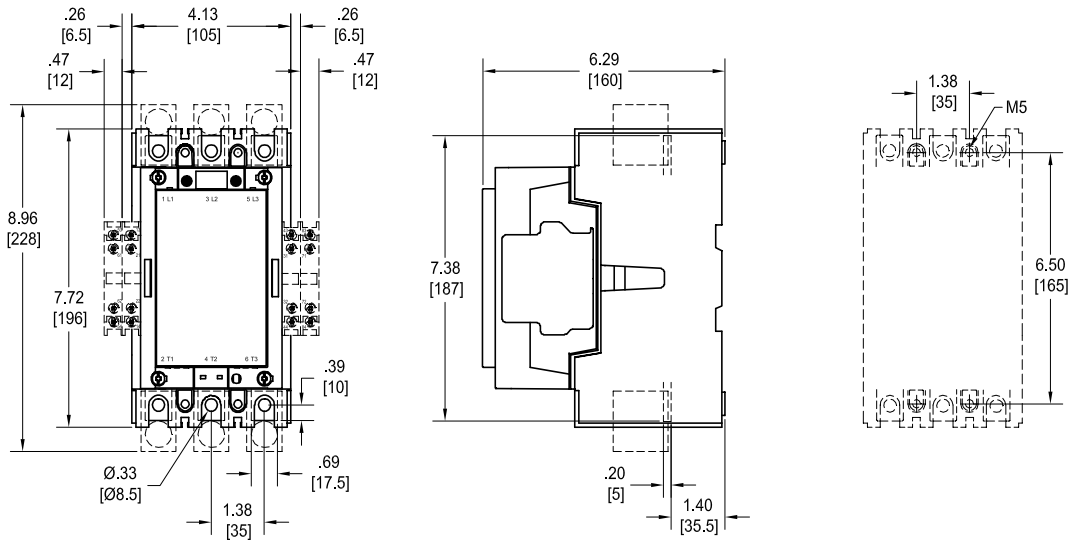

A210W, A260W, A300W

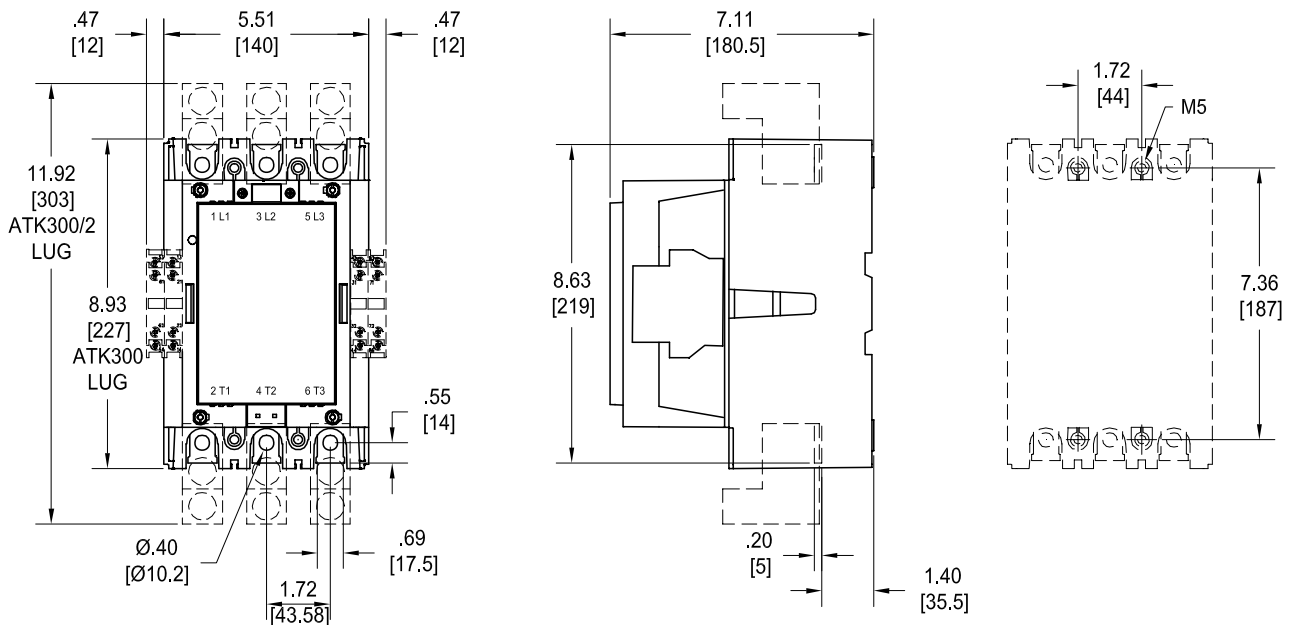

Approximate dimensions AF460W

00.00 Inches
00.00 [Millimeters]

AF460W

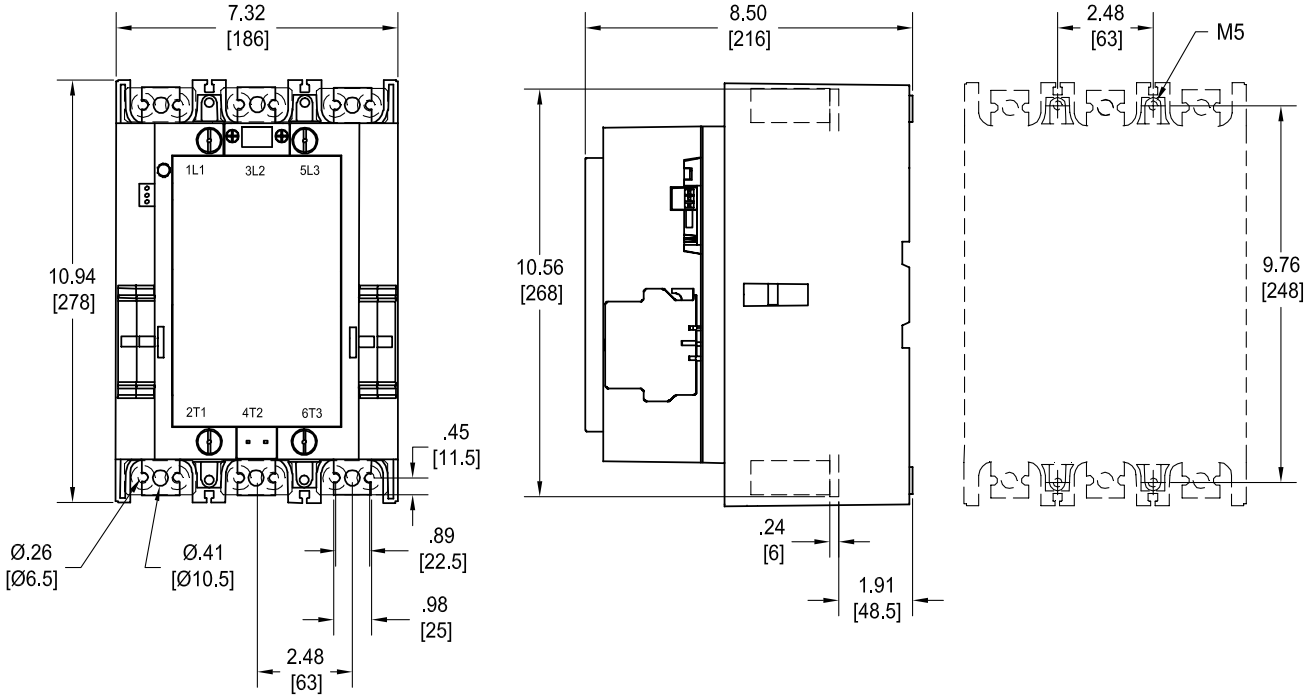

Notes

AC Circuit switching Contactors



AC Circuit switching contactors
Type TAL & TAE

1

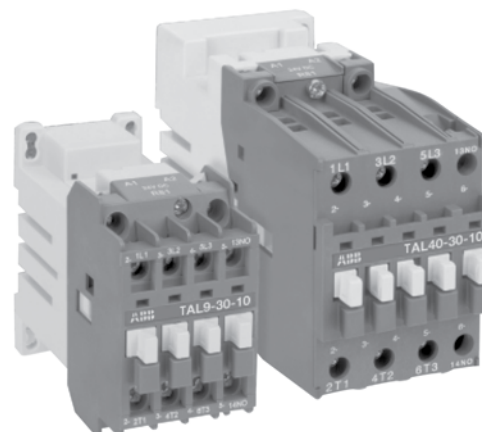

Description

TAL and TAE contactors with a wide coil voltage range are designed to operate in control circuits with large voltage variations. Example: battery supply.

TAL9 - TAE110

D.C. Operated

3 & 4 pole



TAL9-30-01

3 Pole

General purpose current		Maximum motor horsepower ratings HP				Standard auxiliary contacts		Catalog number	List price
AC1	AC3	208V	240V	480V	575/600V	N.O.	N.C.		
22	9	2	2	5	7.5	1 0	0 1	TAL9-30-10- Δ TAL9-30-01- Δ	\$ 159
25	11	3	3	7.5	10	1 0	0 1	TAL12-30-10- Δ TAL12-30-01- Δ	199
28	16	5	5	10	15	1 0	0 1	TAL16-30-10- Δ TAL16-30-01- Δ	216
45	25	7.5	10	20	25	1 0	0 1	TAL26-30-10- Δ TAL26-30-01- Δ	274
55	30	10	10	25	30	1 0	0 1	TAL30-30-10- Δ TAL30-30-01- Δ	374
60	42	10	15	30	40	1 0	0 1	TAL40-30-10- Δ TAL40-30-01- Δ	432
100	50	15	20	40	50	0 1	0 1	TAE50-30-00- Δ TAE50-30-11- Δ	388 428
125	75	25	30	60	75	0 1	0 1	TAE75-30-00- Δ TAE75-30-11- Δ	560 600
146	96	30	30	60	75	1	1	TAE95-30-11- Δ	640
160	110	30	40	75	100	1	1	TAE110-30-11- Δ	795

Δ To select a coil voltage, substitute the code from the Coil Voltage Selection Chart for the Δ .

4 Pole

Rated operational current		Maximum motor horsepower ratings HP				Standard auxiliary contacts		Catalog number	List price
AC1 0 \leq 40°C	AC1 0 \leq 55°C	208V	240V	480V	575/600V	N.O.	N.C.		
22	20	2	2	5	7.5	0	0	TAL9-40-00- Δ	\$ 162
28	25	5	5	10	15	0	0	TAL16-40-00- Δ	220
45	40	7.5	10	20	25	0	0	TAL26-40-00- Δ	282
70	60	10	10	25	30	0	0	TAE45-40-00- Δ	405
100	85	15	20	40	50	0	0	TAE50-40-00- Δ	505
125	105	25	30	60	75	0	0	TAE75-40-00- Δ	615

Δ To select a coil voltage, substitute the code from the Coil Voltage Selection Chart for the Δ .

4 Pole mounted with 2 N.O. & 2 N.C. main poles

Rated operational current		Maximum motor horsepower ratings HP				Standard auxiliary contacts		Catalog number	List price
AC1 0 \leq 40°C	AC1 0 \leq 55°C	208V	240V	480V	575/600V	N.O.	N.C.		
22	20	2	2	5	7.5	0	0	TAL9-22-00- Δ	\$ 162
28	25	5	5	10	15	0	0	TAL16-22-00- Δ	247
45	40	7.5	10	20	25	0	0	TAL26-22-00- Δ	319

Δ To select a coil voltage, substitute the code from the Coil Voltage Selection Chart for the Δ .

These contactors can be used for controlling either 2 separate circuits, i.e. 2 loads with 2 separate supplies, or 1 circuit comprising 2 separate loads with 1 single supply. When the contactor operates, there is no mechanical overlapping between the N.O. main poles and N.C. main poles: BREAK before MAKE.

NOTE: These contactors are not suitable for a reversing starter or a star-delta starter or for controlling a single load from 2 separate supplies.

Coil characteristics

No extra voltages applicable on the U_c min. - max. values of the Coil Voltage selection table.

Coil consumption at U_c max. and $q = 20$ °C:

- 9 W pull-in/holding for TBC type
- 450 W pull-in/ 7 W holding for TAE 50 and TAE 75 types
- 950 W pull-in/ 7 W holding for TAE 95 and TAE 110 types

Coil voltage selection

Min.	U_c	Max	Voltage
17	-	32	51
24	-	45	52
36	-	65	54
42	-	78	58
50	-	90	55
77	-	143	62
90	-	150	66
152	-	264	68

Surge suppressors for contactor coils

For mounting on contactor type	Control voltage	Packing	Weight	Catalog number	List price
TAE/AE45 – TAE/AE75 TAL9 – TAL30	12 to 32 VDC	2	0.015	RT5/32	\$ 30
	25 to 65 VDC	2	0.015	RT5/65	
	50 to 90 VDC	2	0.015	RT5/90	
	77 to 150	2	0.015	RT5/150	
	150 to 264	2	0.015	RT5/264	

Technical data

Type	Control circuit	Opening time growth factor	Residual overvoltage or clipping voltage	Remarks
RT5 /...transil diode			Advantages	<ul style="list-style-type: none"> • Good energy absorption • Unpolarized system • Simple, reliable system Disadvantages <ul style="list-style-type: none"> • A certain delay on drop out which does not reduce contactor breaking capacity
32	DC	2.5 to 3	50V	
65	DC	2.5 to 3	100V	
90	DC	2.5 to 3	150V	
150	DC	2.5 to 3	210V	
264	DC	2.5 to 3	390V	

NOTE: For all other accessories, see the Accessories section for across the line contactors, pages 1.16 – 1.32.
 TAL contactors use the same accessories as AL contactors.
 TAE contactors use the same accessories as AE contactors.

Technical data

Mounting Distance – for coil operating limits U_c min. - U_c max.

A mm	B mm	Ambient temp. °C	Max. switching frequency Operating cycles/h
2	20	≤ 20	1200
5	20	≤ 55	1200

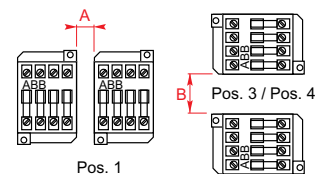

Add-on accessories

Contactors	Max. number of auxiliary contact blocks						Timer TP - A	Interlock unit	Label marker
	CA5-10	CA5-01	CA5-40	CA5-31	CA5-22	CA5-04			
pos. 1, 3 or 4 TAL - -30 - 00 TAL - -30 - 10 TAL - -40 - 00	4	2	1	1	1	-	-	VE5-1	BA5-50
pos. 1, 3 or 4 TAL - -30 - 01	4	1	1	1	-	-	-	VE5-1	BA5-50
pos. 1, 3 or 4 TAL - -22 - 00	4	-	1	-	-	-	-	VE5-1	BA5-50
pos. 1 ± 30° TAL - all types	-	-	-	-	-	-	-	VE5-1	BA5-50
all positions TAE -	6	6	1	1	1	1	1	VE5-2 ①	BA5-50

Note: Railway (traction) projects on request. Type RT surge suppressors are suitable for TAL and TAE contactors.

Mounting positions:

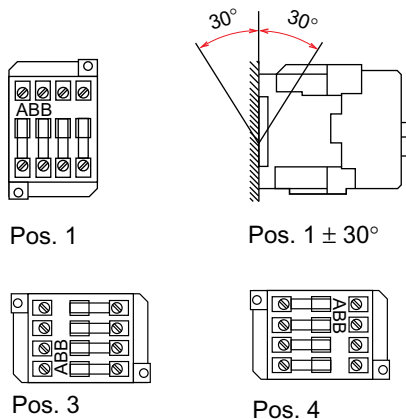

① Only valid for TAE 50-30-00 and TAE 75-30-00.

DC Circuit switching Contactors



DC Circuit switching contactors Type GA75 & GAE75

1

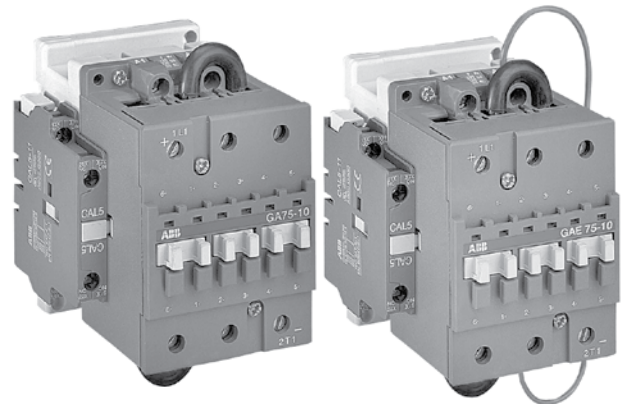

General

Arc suppression is more difficult in DC than in AC. To choose a contactor, it is necessary to know the current and voltage to be broken as well as the L/R time constant of the power circuit to be controlled.

Here are some typical time constant values:

- Non inductive loads such as resistance furnaces: $L/R \approx 1$ ms.
- Shunt motors: $L/R \approx 2$ ms.
- Series motors: $L/R \approx 7.5$ ms.

Remark: the addition of a resistor in parallel with an inductive winding makes arc suppression easier.

Types

- GA75-10-...** AC operated contactor
- GAE75-10-...** DC operated contactor

Description

GA and **GAE** contactors are mounted with arc chutes with permanent magnets specially designed for DC breaking.

The three contactor paths are arranged in series via two supplied and mounted insulated connections (25 mm²).

The **GA75** and **GAE75** are “single-pole” devices for which the connection polarities, indicated next to the connection terminals, must be respected. See wiring diagram information on next page.

GA75 - GAE75

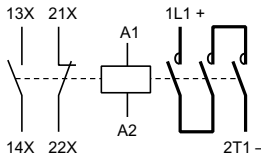
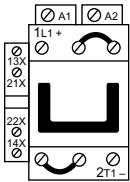

GA75-10-00-84

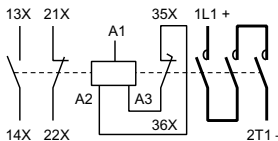
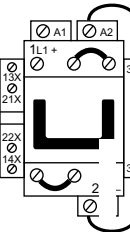

GAE75-10-00-84

Maximum rated operational current					Mounted auxiliary contacts		Catalog number	List price
DC-1		DC-3	DC-5		N.O.	N.C.		
$U_e \leq 440V$ A	$U_e \leq 600V$ A	$U_e \leq 440V$ A	$U_e \leq 220V$ A	$U_e \leq 440V$ A				
100	75	85	85	35	-	-	GA75-10-00-84	\$ 570
100	75	85	85	35	1	1	GAE75-10-11-81	705

Rated insulation voltage $U_i = 1000V$ d.c. according to IEC 947-4-1.
Maximum switching frequencies: 300 operating cycles/h

Coil voltage selection

All AC operated catalog numbers include a 120VAC coil. All DC operated catalog numbers include a 24VDC coil. To select other coil voltages, substitute the code from the Coil Voltage Selection Chart for the two digits after the last dash in the catalog number.

Ex.: A 240VAC coil is required for a GA75 contactor: GA75-10-00-80
A 110VDC coil is required for a GAE75 contactor: GAE75-10-00-86

Coil voltage selection chart

Hz	Cntr type	Volts															
		12	24	48	110	120	125	208	220	240	277	380	415	440	480	500	600
60	GA		81	83	84	84		34	75	80	42	48	86	86	51	53	55
50	GA		81	83	84				80				85	86			55
DC	GAE	80	81	83	86		87			88	89						

For other voltages, see page 1.26.

Accessories

Standard **A** and **AE 40 - 75** contactor accessories are suitable for **GA75** and **GAE75** contactors. Coils are the standard coils for **A** and **AE50 - 75** contactors. Contacts cannot be changed.

Wiring diagrams

In D.C. circuits, the source to earth (or frame) connection mode is an important element.

Three modes are mainly used:

- A** – insulated source, i.e. unearthed (or not connected to the frame).
- B** – source earthed via its central point.
- C** – source earthed via one of its outer poles.

Modes **A** and **B** do not impose any constraints with regard to the distribution of the contactor poles between the two source/load connecting branches. Mode **C** requirements are therefore suitable for modes **A** and **B**. For mode **C**, all the poles necessary for breaking must be installed in series between the load and the ungrounded source polarity. We recommend this solution for all connection modes.

The above provisions relate to power circuit switching, the SCPD (Short-Circuit Protection Device) must comply with protection rules.

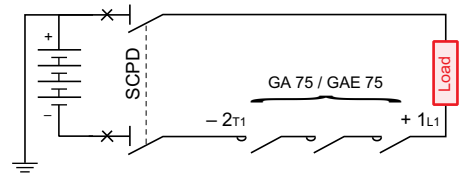
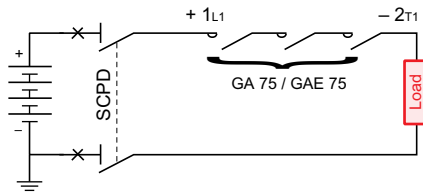

Approximate dimensions (mm)

GA75

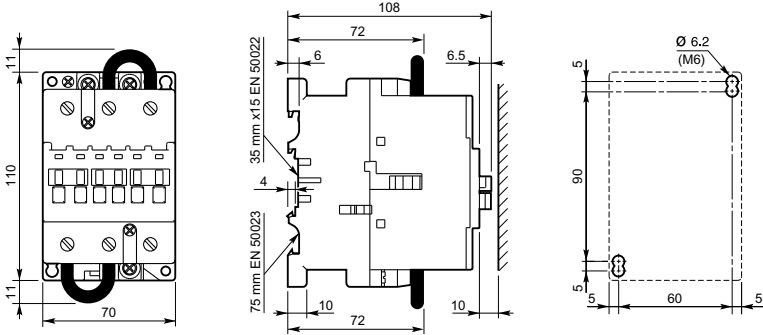

GAE75

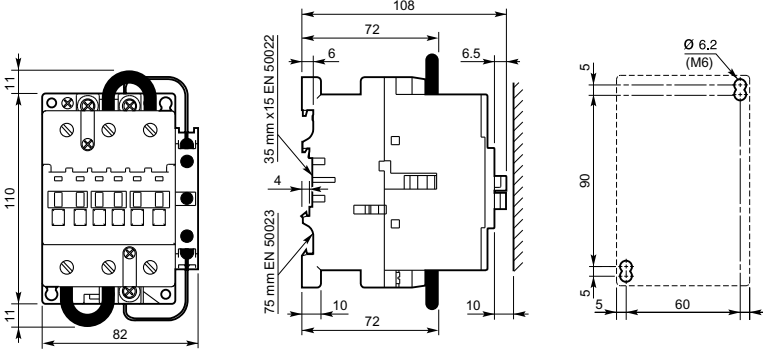

Notes

Bar Contactors

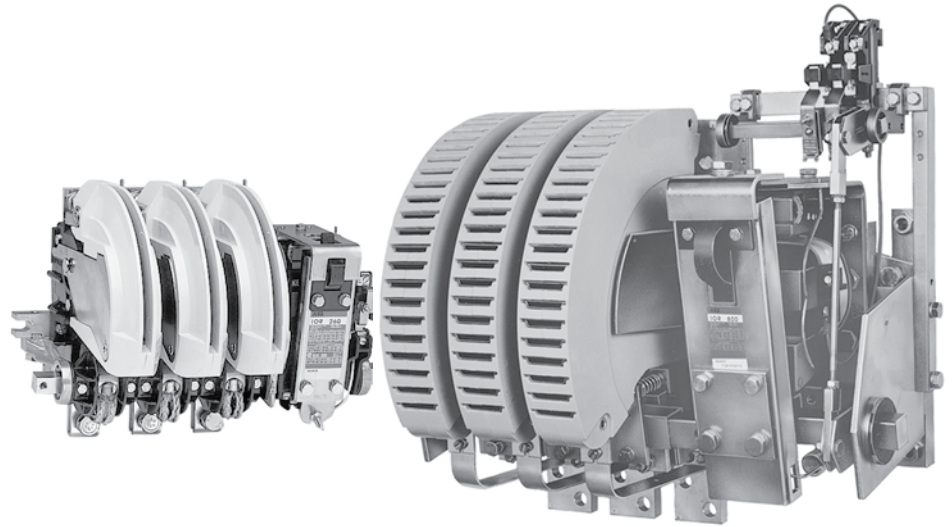

Description

- Variable number and type of main poles, (N.O., N.C.)
- Large number and type of auxiliary contacts
- Extremely versatile and easily accessible for maintenance
- Main poles maximum operating voltage:
 - AC switching up to 500 V, Type IOR
 - AC switching up to 1200V, Type IOR – MT
 - DC switching up to 440V, Type IOR
 - DC switching up to 750V, Type IOR – CC
- Specific construction available as standard:
 - Contactors with N.O./N.C. main poles, with or without overlapping
 - Contactors with magnetic latch or mechanical latch

Applications

Bar mounted contactors are largely used in the iron and steel industry for traction (rolling stock), electrolysis and hoisting equipment for applications from 63A to 5000A.

Standards

Bar contactors comply with major international standards:

- | | |
|-------------------|---|
| • IEC 947-4-1 | International Electrotechnical Commission |
| • UTE NF C 63-110 | France |
| • VDE 0660 | Germany |
| • BS 5424 | Great Britain |
| • NBN 222-2 | Belgium |

Please fill out the form on the next page with the required information and fax to us at 940-397-7085, ATTN: Standard control. We will get right back to you!

Specification check list

Customer

Contact person Date

Tel. e-mail

Quantity Requested delivery date

Project / Application

ABB

Contact person

Tel.

Power Circuit

a.c. switching

Application type

AC-1 (resistive load)

AC-3 (starting, switching off running motors)

No load breaking

Other

Number of poles: N.O. N.C.

Rated operational current I_n A

Rated operational voltage U_n V Hz

or

d.c. switching

Application type

DC-1 (resistive load)

DC-3 (shunt motors)

DC-5 (series motors)

No load breaking

Other L/R ms

Number of poles: N.O. N.C.

Rated operational current I_n A

Making current A

Breaking current min. A max. A

Rated operational voltage U_n V d.c.

Auxiliary contacts

Number of N.O. auxiliary contacts

Number of N.C. auxiliary contacts

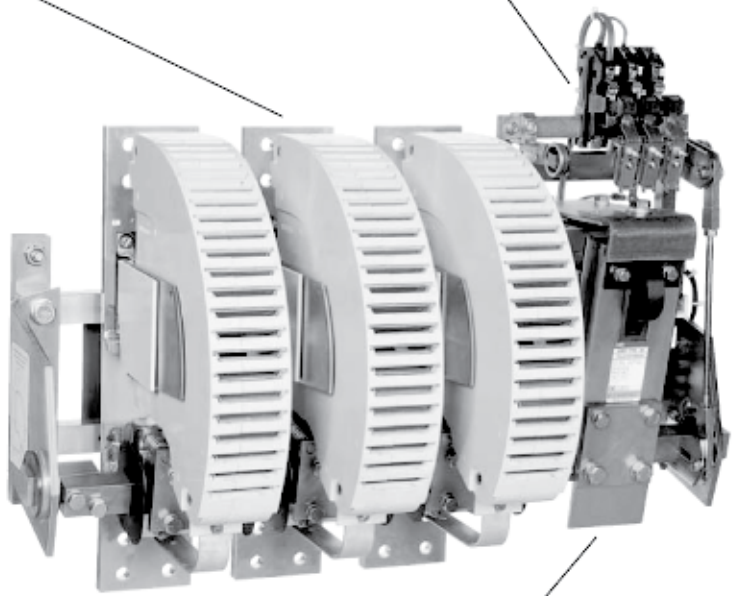

Control circuit (coil)

a.c. Voltage V Hz

d.c. Voltage V d.c.

Options

Magnetical latching

Mechanical latching

Operating conditions

Switching frequency cycles/h

Mech. Durability required (millions of operating cycles)

Remarks

Accessories

Please add any other useful documents for further information e.g. technical specification, drawing, wiring diagram, etc.

Replacement of an existing contactor

Brand

Typ

Fixing dimension F = mm

Overall dimensions W = mm

H = mm

D = mm

