



"Made with pride in the USA"

**Catalog
CCT-11A**

Fusing chart update



**Effective Date:
June 10, 2011**

Supersedes: CCT-10B

MICRON INDUSTRIES CATALOG CCT-11A

REPLACES CCT-10B

Table of Contents

<i>THE MICRON EDGE</i>	3
- Warranty	
Transformer Selection Process	4-5
Standards	6
-UL/CSA	
-CUL	
-IEC	
Control Transformers	
Series 2 ImperviTRAN & ImperviTRAN	8-13
-Connection Diagrams	14
-Accessories	15-17
Overcurrent Protection Tables (UPDATED)	18
GlobalTRAN	19-24
-Connection Diagrams	25
Medium Voltage	26
Power Supplies	
<i>DINergy</i> Power Supplies	27-29
LVGP	
-Overview	30
Notes	31

THE MICRON EDGE

**While other manufacturers
treat transformers as
just one of a variety of
products, transformers
are THE major product
focus for Micron**

**This focus and resulting
commitment to excellence,
exemplified in our
unprecedented 20-year
warranty¹, has made
Micron**

#1

**with specifiers of
transformers
for over 30 years.**

¹ 20 years applies to all 600 volt class Control Transformer product. LVGP and Medium Voltage are warranted for one year, Power Supplies for five.

TRANSFORMER SELECTION PROCESS

Determining Inrush and Voltage Requirements

Selecting a transformer for industrial control circuit applications requires knowledge of the following terms:

INRUSH VA is the product of the load voltage (V) multiplied by the current (A) that is required during start-up. It is calculated by adding the inrush VA requirements of all devices (contactors, timers, relays, pilot lights, solenoids, etc.), which will be energized together. Inrush VA requirements are best obtained from the component manufacturer.

SEALED VA also called Steady State VA, is the product of the load voltage (V) multiplied by the current (A) that is required to operate the circuit after initial start-up or under normal operating conditions. It is calculated by adding the sealed VA requirements of all electrical components of the circuit that will be energized at any given time. Sealed VA requirements are best obtained from the component manufacturer.

PRIMARY VOLTAGE is the voltage available from the electrical distribution system and its operational frequency, which is connected to the transformer supply voltage (H) terminals.

SECONDARY VOLTAGE is the voltage required for load operation, which is connected to the transformer load voltage (X) terminals.

Once the circuit variables have been determined, transformer selection is a simple 5-step process as follows:

1. Determine the Application Inrush VA by using the following industry accepted formula.

$$\text{Application Inrush VA} = \sqrt{(\text{INRUSH VA})^2 + (\text{SEALED VA})^2}$$

2. Refer to the Regulation Data Chart. If the primary voltage is basically stable and does not vary by more than 5% from nominal, the

REGULATION DATA CHART

Transformer VA Rating	Inrush VA at 20% Power factor		
	NEMA / IEC 95% Sec. Voltage	NEMA / IEC 90% Sec. Voltage	NEMA / IEC 85% Sec. Voltage
25 ¹	100 / ----	130 / ---	150 / ---
50 ¹	170 / 190	200 / 220	240 / 270
75 ¹	310 / 350	410 / 460	540 / 600
100 ¹	370 / 410	540 / 600	730 / 810
150 ²	780 / 850	930 / 1030	1150 / 1270
200 ²	810 / 900	1150 / 1270	1450 / 1600
250 ²	1400 / 1540	1900 / 2090	2300 / 2530
300 ²	1900 / 2090	2700 / 2970	3850 / 4240
350 ²	3100 / 3410	3650 / 4020	4800 / 5280
500 ²	4000 / 4400	5300 / 5830	7000 / 7700
750 ²	8300 / 9130	11000 / 12100	14000 / 15400
1000 ²	15000 / 16500	21000 / 23000	27000 / 29500
1000 ³	9000 / 9900	13000 / 14300	18500 / 20300
1500 ³	10500 / 11500	15000 / 16500	20500 / 22500
2000 ³	17000 / 18900	25500 / 27300	34000 / 36400
3000 ³	24000 / 25700	36000 / 38500	47500 / 50200
5000 ³	55000 / 58800	92500 / 98900	115000 / 122000

To comply with NEMA standards, which require all magnetic devices to operate successfully at 85% of rated voltage, the 90% secondary column is most often used in selecting a transformer. No comparable requirement is available for IEC.

¹ For units with class 105° C insulation system.

² For units with class 130° C insulation system.

³ For units with class 180° C insulation system

INDUSTRY AND INTERNATIONAL STANDARDS

Micron offers a broad line of standard transformers, each made with the finest materials and workmanship. Laminations of high-grade silicon steel assure optimum performance and the finest quality copper magnet wire assures efficient operation. Insulation materials are of the highest rating available for the temperature class and mounting brackets of heavy gauge steel add strength and stability. All are UL 506 listed (File # E46323) and either C-UL or CSA certified (File # LR27533) and meet NEMA and ANSI requirements.

In response to the change in compliance standards for CE marking of industrial control transformers as required by IEC/EN guidelines, Micron has introduced new GlobalTRAN models in compliance with EN61558-2. This new IEC/EN standard replaces the previous IEC/EN 60742 standard for control power transformers that expired on December 31, 2003. The Micron design engineering department has produced 61558-2 compliant designs that permit the customer to retain mounting layouts used for the previous Micron 60742 designs.

GlobalTRAN® products carry the CE mark, certifying 100% compliance with requirements of EN61558 for Non-Short Circuit Proof Isolating Transformers. GlobalTRAN control transformers feature touch-proof terminals, utilizing either Micron's SafeTouch terminal covers or a touch-proof terminal block, and meet true IP-20 or IP-00 terminal protection ratings as defined by IEC-529.

Of course, all GlobalTRAN products carry either UL listing and CSA certification or cUL.

GlobalTRAN is the most reliable and versatile control transformer in the industry today.

DINergy™ products are designed to meet the most stringent international specifications for safety and EMI; and are designed to compact dimensions. All carry C-UL certification to UL60950 and UL508 plus the CE mark signifying certification to EN60950, EN 55022B, EN 61000-3-2 and IEC610004-2, 3, 4, 5, 6, 8, 11.

ImperviPOWER 67™ products are designed to meet the most stringent international specifications; and are designed to compact dimensions. All carry certification to UL60950, CSA 22.2, EN60950, EN 55011, EN 6100-6, EN6000-6-2, -4-2, -4-3, -4-4, -4-5, -4-6 and -4-11.

IMPERVITRAN

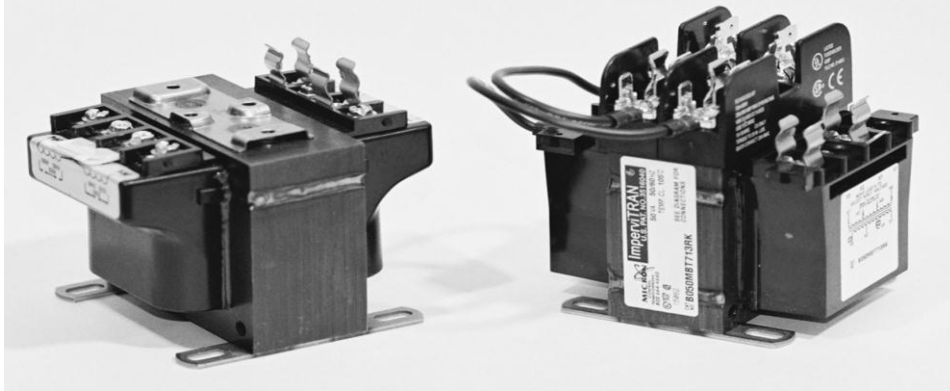

SIMPLY – THE MOST VERSATILE AVAILABLE

ImperviTRAN's feature-laden Series 2 design. Developed to address **ALL** customer needs with a product designed in a highly efficient manner. ImperviTRAN designs span over 35 years of market leadership.

UL/CSA or C-UL Family Listing

- Absolute flexibility of design for 600 volt class product

Fully encapsulated coil

- Tough environment-proof construction
- Eases wire routing around the transformer

Fusion-welded coil terminations instead of solder joints

- Eliminates cold solder joint breakage, improves conductivity
- Provides a lead-free RoHS compliant construction

Face-on terminal labels with large schematic indicators

- Terminal designations clearly visible to the installer and technician
- Indicators aligned with terminal screws for clarity

SEMS screw terminal strips as an integral part of the coil bobbin

- Allows bare wire and terminal connection methods
- Easily adaptable to slot, Phillips and hex driver tools
- Robust physical support instead of "floating" terminal strips

Integral accessory mounting plate on transformer top

- Allows field modification to block-style primary fusing
- Reduces SKU count for fused/non-fused applications
- Provides mounting platform for additional items (DIN Rail)

Standard strap brackets or optional mounting plate

- Features a superior weld result for vibration-resistant stability
- Offers common mounting template across a wide range of voltages
- Alternate plates available for OEM volumes

IP-20 cover kits available

- Quickly convertible to an IP-20 safety level

CONTROL TRANSFORMERS

GENERAL SPECIFICATIONS:

STYLE: SERIES 2 IMPERVITRAN
 APPROVALS: UL/Cul FILE# E46323
 TEMP CLASS: 105°C/130°C
 VA SIZES: 50-1500

STYLE: IMPERVITRAN (NOT SERIES 2)

APPROVALS: UL LISTED FILE# E46323/ CSA APPROVED FILE# LR27533
 TEMP CLASS: 105°C/130°C/180°C
 VA SIZES: 1000-5000

SUFFIX DESCRIPTION:

"K" IN SUFFIX DENOTES INSTALLED SECONDARY FUSE CLIPS
 "R" IN SUFFIX DENOTES INSTALLED CLASS "CC" PRIMARY FUSE BLOCK
 TWO LETTER SUFFIX = TEMP CLASS 105C
 THREE LETTER SUFFIX ENDING "F" = TEMP CLASS 130C
 THREE LETTER SUFFIX ENDING "H" = TEMP CLASS 180C

**TERMINAL TORQUE:
 ALL IMPERVITRAN PRODUCT**

≤30A: 20 INCH-POUNDS
 >30A: 30 INCH-POUNDS

CATALOG NUMBER GROUP "A"	VOLTAGE:	
	PRI: 220x440, 230x460, 240x480	SEC: 110/115/120
	VA	AMPS
B050BTZ13JK	50	0.43
B050BTZ13RB		
B075BTZ13JK	75	0.65
B075BTZ13RB		
B100BTZ13JK	100	0.87
B100BTZ13RB		
B150BTZ13JKF	150	1.30
B150BTZ13RBF		
B200BTZ13JKF	200	1.74
B200BTZ13RBF		
B250BTZ13JKF	250	2.17
B250BTZ13RBF		
B300BTZ13JKF	300	2.61
B300BTZ13RBF		
B350BTZ13JKF	350	3.04
B350BTZ13RBF		
B500BTZ13JKF	500	4.35
B500BTZ13RBF		
B750BTZ13JKF	750	6.52
B750BTZ13RBF		
B1K0BTZ13JKF	1000	8.70
B1K0BTZ13RBF		
B1K5BTZ13JKF	1500	13.04
B1K5BTZ13RBF		
B2K0BTZ13JKH	2000	17.39
B2K0BTZ13RBH		
B3K0BTZ13JXH	3000	26.09
B5K0BTZ13JXH	5000	43.48

CATALOG NUMBER GROUP "C"	VOLTAGE:	
	PRI: 120x240	SEC: 24
	VA	AMPS
B050LP7JK	50	2.08
B050LP7RB		
B075LP7JK	75	3.13
B075LP7RB		
B100LP7JK	100	4.17
B100LP7RB		
B150LP7JKF	150	6.25
B150LP7RBF		
B200LP7JKF	200	8.33
B200LP7RBF		
B250LP7JKF	250	10.42
B250LP7RBF		
B300LP7JKF	300	12.50
B300LP7RBF		
B350LP7JKF	350	14.58
B350LP7RBF		
B500LP7JKF	500	20.83
B500LP7RBF		
B750LP7JKF	750	31.25
B750LP7RBF		

CATALOG NUMBER GROUP "F"	VOLTAGE:	
	PRI: 208/277	SEC: 120
	VA	AMPS
B050MQ15XK	50	0.42
B050MQ15RK		
B075MQ15XK	75	0.63
B075MQ15RK		
B100MQ15XK	100	0.83
B100MQ15RK		
B150MQ15XKF	150	1.25
B150MQ15RKF		
B200MQ15XKF	200	1.67
B200MQ15RKF		
B250MQ15XKF	250	2.08
B250MQ15RKF		
B300MQ15XKF	300	2.50
B300MQ15RKF		
B350MQ15XKF	350	2.92
B350MQ15RKF		
B500MQ15XKF	500	4.17
B500MQ15RKF		
B750MQ15XKF	750	6.25
B750MQ15RKF		

GROUP "G"		
VOLTAGE:		
	PRI: 208/230/460	SEC: 115
	VA	AMPS
B050MBT13XK	50	0.43
B050MBT13RK		
B075MBT13XK	75	0.65
B075MBT13RK		
B100MBT13XK	100	0.87
B100MBT13RK		
B150MBT13XKF	150	1.30
B150MBT13RKF		
B200MBT13XKF	200	1.74
B200MBT13RKF		
B250MBT13XKF	250	2.17
B250MBT13RKF		
B300MBT13XKF	300	2.61
B300MBT13RKF		
B350MBT13XKF	350	3.04
B350MBT13RKF		
B500MBT13XKF	500	4.35
B500MBT13RKF		
B750MBT13XKF	750	6.52
B750MBT13RKF		
B1K0MBT13XKF	1000	8.70
B1K0MBT13RKF		
B1K5MBT13XKF	1500	13.04
B1K5MBT13RKF		
B2K0MBT13XKH	2000	17.39
B2K0MBT13RKH		
B3K0MBT13XXH	3000	26.09
B5K0MBT13XXH	5000	43.48

GROUP "B"		
VOLTAGE:		
	PRI: 240x480	SEC: 24
	VA	AMPS
B050PU7JK	50	2.08
B050PU7RB		
B075PU7JK	75	3.13
B075PU7RB		
B100PU7JK	100	4.17
B100PU7RB		
B150PU7JKF	150	6.25
B150PU7RBF		
B200PU7JKF	200	8.33
B200PU7RBF		
B250PU7JKF	250	10.42
B250PU7RBF		
B300PU7JKF	300	12.50
B300PU7RBF		
B350PU7JKF	350	14.58
B350PU7RBF		
B500PU7JKF	500	20.83
B500PU7RBF		
B750PU7JKF	750	31.25
B750PU7RBF		

GROUP "E"		
VOLTAGE:		
	PRI: 550/575/600	SEC: 110/115/120
	VA	AMPS
B050WZ13XK	50	0.43
B050WZ13RK		
B075WZ13XK	75	0.65
B075WZ13RK		
B100WZ13XK	100	0.87
B100WZ13RK		
B150WZ13XKF	150	1.30
B150WZ13RKF		
B200WZ13XKF	200	1.74
B200WZ13RKF		
B250WZ13XKF	250	2.17
B250WZ13RKF		
B300WZ13XKF	300	2.61
B300WZ13RKF		
B350WZ13XKF	350	3.04
B350WZ13RKF		
B500WZ13XKF	500	4.35
B500WZ13RKF		
B750WZ13XKF	750	6.52
B750WZ13RKF		

STYLE: SERIES 2 IMPERVITRAN

CONTROL TRANSFORMERS
STYLE: IMPERVITRAN (NOT SERIES 2)

CATALOG NUMBER GROUP "H"	VOLTAGE:	
	PRI: 230/460/575	
	SEC: 95/115	
	VA	AMPS
B050BTW37XX	50	0.53/0.44
B050BTW37RX		
B075BTW37XX	75	0.79/0.65
B075BTW37RX		
B100BTW37XX	100	1.05/0.87
B100BTW37RX		
B150BTW37XXF	150	1.58/1.30
B150BTW37RXF		
B200BTW37XXF	200	2.11/1.74
B200BTW37RXF		
B250BTW37XXF	250	2.63/2.17
B250BTW37RXF		
B300BTW37XXF	300	3.16/2.61
B300BTW37RXF		
B350BTW37XXF	350	3.68/3.04
B350BTW37RXF		
B500BTW37XXF	500	5.26/4.35
B500BTW37RXF		
B750BTW37XXF	750	7.89/6.52
B750BTW37RXF		
B1K0BTWZ37XKH	1000	10.53/8.70
B1K0BTWZ37RKH		
B1K5BTWZ37XKH	1500	15.79/13.04
B1K5BTWZ37RKH		
B2K0BTWZ37XKH	2000	21.05/17.39
B2K0BTWZ37RKH		
B3K0BTWZ37XXH	3000	31.58/26.09
B5K0BTWZ37XXH	5000	52.63/43.48

CATALOG NUMBER GROUP "J"	VOLTAGE:	
	PRI: 208/230/460	
	SEC: 24/115	
	VA	AMPS
B050-2000-1	50	2.08/0.44
B050-2000-8		
B075-2001-1	75	3.13/0.65
B075-2001-8		
B100-2002-1	100	4.17/0.87
B100-2002-8		
B150-2003-1F	150	6.25/1.30
B150-2003-8F		
B200-2004-1F	200	8.33/1.74
B200-2004-8F		
B250-2005-1F	250	10.42/2.17
B250-2005-8F		
B300-2006-1F	300	12.50/2.61
B300-2006-8F		
B350-2007-1F	350	14.58/3.04
B350-2007-8F		
B500-2008-1F	500	20.84/4.35
B500-2008-8F		
B750-2009-1F	750	31.3/6.5
B750-2009-8F		
B1K0-2010-1F	1000	41.7/8.7
B1K0-2010-8F		

CATALOG NUMBER GROUP "K"	VOLTAGE:	
	PRI: 240x480	
	SEC: 120x240	
	VA	AMPS
B050PU1519JJ	50	0.42/0.21
B050PU1519RR		
B075PU1519JJ	75	0.63/0.31
B075PU1519RR		
B100PU1519JJ	100	0.83/0.42
B100PU1519RR		
B150PU1519JJF	150	1.25/0.63
B150PU1519RRF		
B200PU1519JJF	200	1.67/0.83
B200PU1519RRF		
B250PU1519JJF	250	2.08/1.04
B250PU1519RRF		
B300PU1519JJF	300	2.50/1.25
B300PU1519RRF		
B350PU1519JJF	350	2.92/1.46
B350PU1519RRF		
B500PU1519JJF	500	4.17/2.08
B500PU1519RRF		
B750PU1519JJF	750	6.25/3.12
B750PU1519RRF		

GROUP "I"
VOLTAGE:
 PRI: 380/400/415
 SEC: 110x220

	VA	AMPS
B050RFD34XJ	50	0.46/0.23
B050RFD34RJ		
B075RFD34XJ	75	0.68/0.34
B075RFD34RJ		
B100RFD34XJ	100	0.91/0.46
B100RFD34RJ		
B150RFD34XJF	150	1.37/0.69
B150RFD34RJF		
B200RFD34XJF	200	1.82/0.91
B200RFD34RJF		
B250RFD34XJF	250	2.28/1.14
B250RFD34RJF		
B300RFD34XJF	300	2.72/1.36
B300RFD34RJF		
B350RFD34XJF	350	3.18/1.59
B350RFD34RJF		
B500RFD34XJF	500	4.55/2.27
B500RFD34RJF		
B750RFD34XJF	750	6.82/3.41
B750RFD34RJF		

GROUP "J"
USE SERIES 2 GROUP "J" (ABOVE)
FOR NEW APPLICATIONS!

VOLTAGE:		
PRI: 208/230/460		
SEC: 24/115		
	VA	AMPS
B050MBT713XK	50	2.08/0.44
B050MBT713RK		
B075MBT713XK	75	3.13/0.65
B075MBT713RK		
B100MBT713XK	100	4.17/0.87
B100MBT713RK		
B150MBT713XKF	150	6.25/1.30
B150MBT713RKF		
B200MBT713XKF	200	8.33/1.74
B200MBT713RKF		
B250MBT713XKF	250	10.42/2.17
B250MBT713RKF		
B300MBT713XKF	300	12.50/2.61
B300MBT713RKF		
B350MBT713XKF	350	14.58/3.04
B350MBT713RKF		
B500MBT713XKF	500	20.84/4.35
B500MBT713RKF		

CONTROL TRANSFORMERS
STYLE: IMPERVITRAN (NOT SERIES 2)
STYLE: SERIES 2 IMPERVITRAN

**CATALOG
NUMBER
GROUP "L"**

VOLTAGE:
PRI: 208-600
SEC: 85-130

	VA	AMPS
B050-0482-1	50	0.38
B050-0482-8		
B100-0483-1	100	0.77
B100-0483-8		
B150-0484-1F	150	1.15
B150-0484-8F		
B250-0485-1F	250	1.92
B250-0485-8F		
B350-0486-1F	350	2.69
B350-0486-8F		
B500-0487-1F	500	3.85
B500-0487-8F		
B750-0488-1F	750	5.77
B750-0488-8F		

GROUP "M"

VOLTAGE:
PRI: 240x480, 230x460, 220x440
SEC: 120x240, 115x230, 110x220

	VA	AMPS
B1K0-0500-3F	1000	8.70/4.35
B1K5-0501-3H	1500	13.04/6.52
B2K0-0502-3H	2000	17.39/8.70
B3K0-0503-3H	3000	26.09/13.04
B5K0-0504-3H	5000	43.48/21.74

GROUP "N"

VOLTAGE:
PRI: 240, 347, 380
SEC: 120x240

	VA	AMPS
B1K0-0321-3F	1000	8.33/4.17
B1K5-0322-3H	1500	12.50/6.25
B2K0-0323-3H	2000	16.67/8.33
B3K0-0324-3H	3000	25.00/12.50
B5K0-0325-3H	5000	41.67/20.83

GROUP "P"

VOLTAGE:
PRI: 120x240
SEC: 120x240

	VA	AMPS
B050LP1519JJ	50	0.42/0.21
B100LP1519JJ	100	0.83/0.42
B150LP1519JF	150	1.25/0.63
B250LP1519JF	250	2.08/1.04
B350LP1519JF	350	2.92/1.46
B500LP1519JF	500	4.17/2.08
B750LP1519JF	750	6.25/3.12

DIMENSIONAL DATA

NOTE:
 SERIES 2 AND IMPERVITRAN
 TERMINAL BLOCK CAN HAVE
 4 OR 6 TERMINALS AS NOTED.

PRIMARY FUSE BLOCK ADDS
 1.375" (35MM) TO "C" DIMENSION.

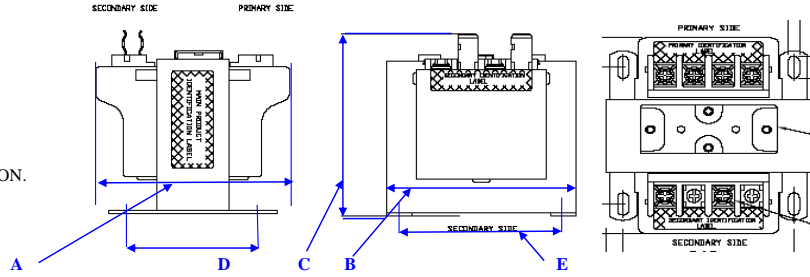

(MATCHED DIMENSIONS)
CATALOG GROUPS
 A, B, C, E, F, G*, H*, I, K, P
VOLTAGE GROUPS

**BTZ13, PU7, LP7, WZ13, MQ15,
 MBT13, BTW37, RFD34, PU1519,
 LP1519**

NOTE: DIMENSION "C" IS A MAXIMUM DIMENSION. IF SECONDARY FUSE CLIPS ARE
 INCLUDED IN DESIGN, DEDUCT A MAXIMUM OF 0.50 (12.7MM) TO REMOVE.
ALWAYS REQUEST CURRENT FACTORY DRAWING FOR FINAL REFERENCE.

		DIMENSIONS INCHES/MM										APPROX WEIGHT LBS
		A		B		C		D		E		
VA		SERIES 2 (MAX)		ALL VERSIONS		MAXIMUM		CENTERS				
		IN	MM	IN	MM	IN	MM	IN	MM	IN	MM	
50	4-TERM	3.78	96	3.00	76	3.14	79	1.96	50	2.50	64	3.00
75	4-TERM	4.03	102	3.00	76	3.14	79	2.42	62	2.50	64	4.00
100	4-TERM	4.03	102	3.38	86	3.46	86	2.42	62	2.82	71	5.20
150	4-TERM	4.03	102	3.75	95	3.77	96	2.82	71	3.13	79	6.00
200	4-TERM	4.38	111	4.50	114	4.40	112	2.42	62	3.75	95	8.00
250	4-TERM	4.38	111	4.50	114	4.40	112	2.82	71	3.75	95	10.00
300	4-TERM	4.75	121	4.50	114	4.40	112	3.18	81	3.75	95	12.00
350	4-TERM	4.75	121	4.50	114	4.40	112	3.75	95	3.75	95	14.00
500	6-TERM	6.11	155	5.25	133	5.14	131	3.88	99	4.38	111	16.00
750	6-TERM	7.61	193	5.25	133	5.14	131	5.38	137	4.38	111	28.00

* GROUP "G" MATCHES IN 75, 150 & 250VA.

G

50	4-TERM	3.78	96	3.00	76	3.14	79	2.21	56	2.50	64	3.50
100	4-TERM	4.00	102	3.38	86	3.46	86	2.62	67	2.82	71	5.70
200	4-TERM	4.38	111	4.50	114	4.40	112	2.82	71	3.75	95	7.00
300	4-TERM	4.75	121	4.50	114	4.40	112	3.75	95	3.75	95	11.00
350	4-TERM	5.75	146	4.50	114	4.40	112	4.72	120	3.75	95	13.00
500	6-TERM	6.11	155	5.25	133	5.14	131	4.38	111	4.38	111	15.00
750	6-TERM	7.61	193	5.25	133	5.14	131	5.87	149	4.38	111	28.00

* GROUP "H" MATCHES IN 200, 250, 300 & 500VA

H

50	4-TERM	4.03	102	3.00	76	2.72	69	2.20	56	2.50	64	3.50
75	4-TERM	4.53	115	3.00	76	2.72	69	2.62	67	2.50	64	4.50
100	4-TERM	4.03	102	3.75	95	3.36	85	2.82	71	3.13	79	6.00
150	4-TERM	4.53	115	3.75	95	3.36	85	3.18	81	3.75	95	7.70
350	4-TERM	5.00	127	4.50	114	3.97	101	3.75	95	3.75	95	16.50
750	6-TERM	8.11	206	5.25	133	4.63	118	5.87	149	4.38	111	28.00

DIAGRAMS BELOW DEPICT INSTALLED PRIMARY FUSING OPTION.

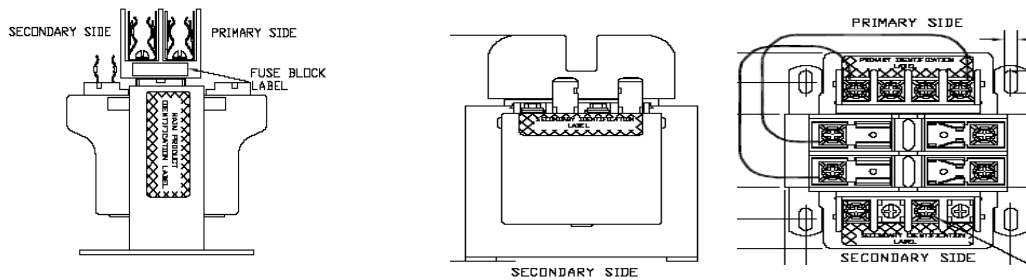

DIAGRAMS DEPICT UNITS 500VA AND UP.

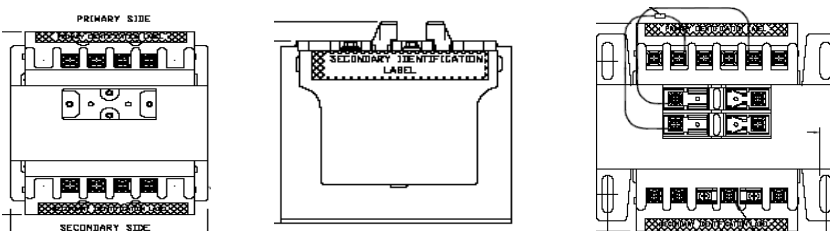

DIMENSIONAL DATA (KVA SIZES)

KVA SIZES CAN EITHER BE SERIES 2 OR IMPERVITRAN

DIAGRAMS DEPICT SERIES 2 DESIGN.

NOTE:
SERIES 2 AND IMPERVITRAN
TERMINAL BLOCK CAN HAVE
4 OR 6 TERMINALS AS NOTED.

PRIMARY FUSE BLOCK ADDS
1.375" (35MM) TO "C" DIMENSION.

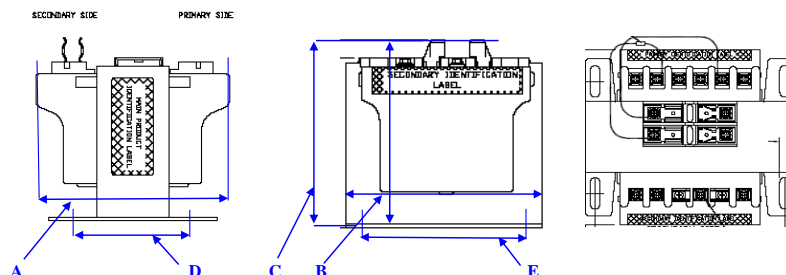

NOTE: DIMENSION "C" IS A MAXIMUM DIMENSION. IF SECONDARY FUSE CLIPS ARE INCLUDED IN DESIGN, DEDUCT A MAXIMUM OF 0.50 (12.7MM) TO REMOVE.

ALWAYS REQUEST CURRENT FACTORY DRAWING FOR FINAL REFERENCE.

DIMENSIONS INCHES/MM

CATALOG (VOLTAGE) GROUP		A		B		C		D		E		APPROX
A (BTZ13)		(MAX)				MAXIMUM		CENTERS				WEIGHT
VA		IN	MM	IN	MM	IN	MM	IN	MM	IN	MM	LBS
1000	6-TERM	6.11	155	6.75	172	6.30	160	3.91	99	6.13	156	30.50
1500	6-TERM	8.11	206	6.75	172	6.32	161	6.12	155	6.13	156	50.10
2000	6-TERM	7.75	197	6.75	172	6.28	160	4.97	126	6.13	156	46.00
3000	6-TERM	8.06	205	9.00	229	7.50	191	5.25	133	7.50	191	55.90
5000	6-TERM	10.38	264	9.00	229	7.50	191	7.56	192	7.50	191	84.40
G (MBT13)												
1000	6-TERM	7.44	189	6.38	162	5.42	138	5.06	129	5.31	135	37.00
1500	6-TERM	8.50	216	6.75	172	5.73	146	6.09	155	6.13	156	53.90
2000	6-TERM	8.13	207	6.75	172	5.75	146	5.25	133	6.13	156	42.00
3000	6-TERM	8.56	217	9.00	229	7.50	191	5.75	146	7.50	191	64.50
5000	6-TERM	10.00	254	9.00	229	7.50	191	7.56	192	7.50	191	97.00
H (BTWZ37)												
1000	6-TERM	7.00	178	6.38	162	5.42	138	5.06	129	5.31	135	31.80
1500	6-TERM	7.45	189	6.75	172	6.29	160	5.25	133	6.13	156	44.20
2000	6-TERM	7.56	192	9.00	229	7.80	198	4.81	122	7.50	191	57.70
3000	6-TERM	8.75	222	9.00	229	7.50	191	5.94	151	7.50	191	76.20
5000	6-TERM	11.00	279	9.00	229	7.50	191	8.19	208	7.50	191	127.40
M												
240/480 X 120/240												
1000	4-TERM	7.00	178	5.25	133	4.25	108	5.38	137	4.38	111	26.30
1500	6-TERM	7.00	178	6.75	172	5.75	146	4.25	108	6.13	156	31.00
2000	6-TERM	7.75	197	6.75	172	5.73	146	4.97	126	6.13	156	46.00
3000	6-TERM	8.06	205	9.00	229	7.50	191	5.25	133	7.50	191	56.00
5000	6-TERM	10.00	254	9.00	229	7.50	191	7.19	183	7.50	191	85.40
N												
240,347,380 X 120/240												
1000	6-TERM	7.38	187	6.38	162	5.44	138	5.06	129	5.31	135	29.00
1500	6-TERM	8.13	207	6.38	162	5.44	138	5.06	129	5.31	135	33.30
2000	6-TERM	8.88	226	6.75	172	5.75	146	6.13	156	6.13	156	50.00
3000	6-TERM	8.50	216	9.00	229	7.50	191	5.69	146	7.50	191	74.00
5000	6-TERM	10.38	264	9.00	229	7.50	191	7.56	192	7.50	191	110.00

DIAGRAMS DEPICT IMPERVITRAN DESIGN.

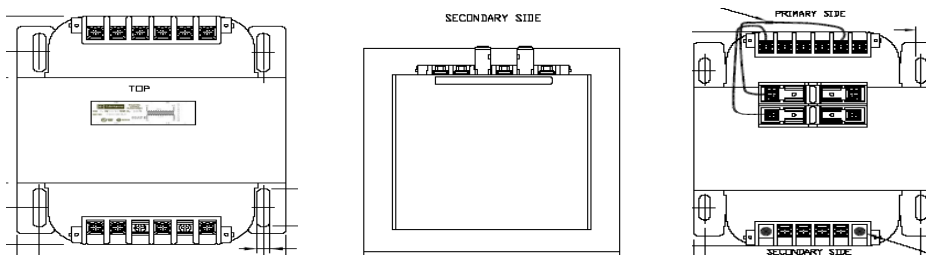

DIMENSIONAL DATA

NOTE:

SERIES 2 AND IMPERVITRAN
TERMINAL BLOCK CAN HAVE
4 OR 6 TERMINALS AS NOTED.

PRIMARY FUSE BLOCK ADDS
1.375" (35MM) TO "C" DIMENSION.

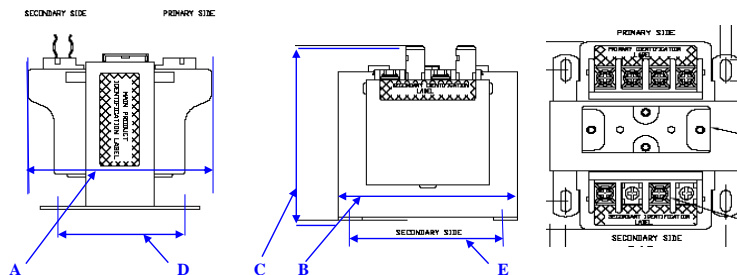

NOTE: DIMENSION "C" IS A MAXIMUM DIMENSION. IF SECONDARY FUSE CLIPS ARE INCLUDED IN DESIGN, DEDUCT A MAXIMUM OF 0.50 (12.7MM) TO REMOVE.
ALWAYS REQUEST CURRENT FACTORY DRAWING FOR FINAL REFERENCE.

**CATALOG (VOLTAGE) GROUP
OBSOLETE GROUP "J"**

ORIGINAL IMPERVITRAN

P/N	TERMS	DIMENSIONS INCHES/MM										
		A		B		C		D		E		APPROX WEIGHT LBS
SERIES 2 (MAX)		IN	MM	IN	MM	IN	MM	IN	MM	IN	MM	
B050MBT713XX	4-TERM	3.50	89	3.00	76	3.14	79	2.25	57	2.50	64	3.40
B075MBT713XX	4-TERM	3.50	89	3.38	86	3.44	87	2.44	62	2.82	71	4.80
B100MBT713XX	4-TERM	3.63	92	3.75	95	3.78	96	2.44	62	3.13	79	5.90
B150MBT713XXF	4-TERM	4.00	102	3.75	95	3.78	96	3.19	81	3.13	79	8.00
B200MBT713XXF	4-TERM	4.38	111	4.50	114	4.40	112	3.00	76	3.75	95	9.80
B250MBT713XXF	4-TERM	4.38	111	4.50	114	4.40	112	3.75	95	3.75	95	12.00
B300MBT713XXF	4-TERM	5.19	132	5.25	133	5.14	131	3.88	99	4.38	111	14.00
B350MBT713XXF	4-TERM	5.00	127	5.25	133	5.14	131	3.88	99	4.38	111	15.00
B500MBT713XXF	4-TERM	5.50	140	5.25	133	5.14	131	5.38	137	4.38	111	18.00

J

SERIES 2

B050-2000-1	4-TERM	4.53	115	3.00	76	3.14	79	2.82	71	2.50	64	3.40
B075-2001-1	4-TERM	4.53	115	3.75	95	3.78	96	2.82	71	3.13	79	4.80
B100-2002-1	4-TERM	4.53	115	3.75	95	3.78	96	3.00	76	3.13	79	5.90
B150-2003-1F	4-TERM	5.03	128	3.75	95	3.78	96	3.19	81	3.13	79	8.00
B200-2004-1F	4-TERM	4.38	111	4.50	114	4.40	112	3.00	76	3.75	95	9.80
B250-2005-1F	4-TERM	4.75	121	4.50	114	4.40	112	3.75	95	3.75	95	12.00
B300-2006-1F	4-TERM	6.11	155	5.25	133	5.14	131	3.88	99	4.38	111	14.00
B350-2007-1F	6-TERM	6.11	155	5.25	133	5.14	131	3.88	99	4.38	111	15.00
B500-2008-1F	6-TERM	7.11	181	5.25	133	5.14	131	5.38	137	4.38	111	18.00
B750-2009-1F	6-TERM	7.11	181	6.75	172	6.30	160	4.97	126	6.13	156	38.60
B1K0-2010-1F	6-TERM	8.13	207	6.75	172	5.73	146	6.13	156	6.13	156	48.40

L

ORIGINAL IMPERVITRAN

B050-0482-1	6-TERM	3.44	87	3.88	99	3.38	86	2.41	61	2.81	71	4.00
B100-0483-1	6-TERM	4.00	102	3.75	95	3.50	89	3.00	76	3.13	79	6.60
B150-0484-1F	6-TERM	4.00	102	4.50	114	4.50	114	2.82	71	3.75	95	8.70
B250-0485-1F	6-TERM	5.75	146	4.50	114	4.50	114	4.38	111	3.75	95	11.40
B350-0486-1F	6-TERM	5.14	131	5.25	133	4.75	121	4.38	111	4.38	111	13.60
B500-0487-1F	6-TERM	7.19	183	5.14	131	4.75	121	5.88	149	4.38	111	17.40
B750-0488-1F	6-TERM	6.50	165	6.75	172	6.00	152	4.25	108	6.13	156	27.50

DIAGRAMS BELOW DEPICT INSTALLED PRIMARY FUSING OPTION.

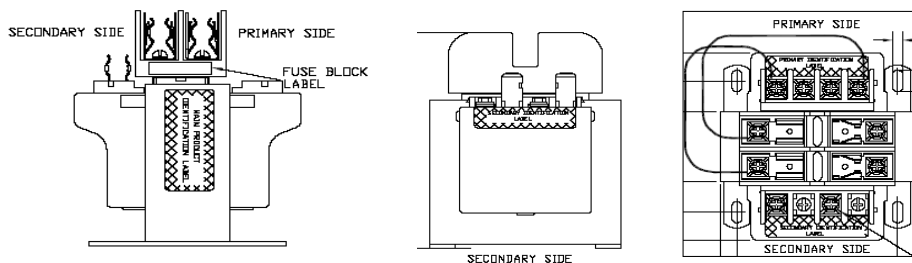

DIAGRAMS DEPICT UNITS 500VA AND UP.

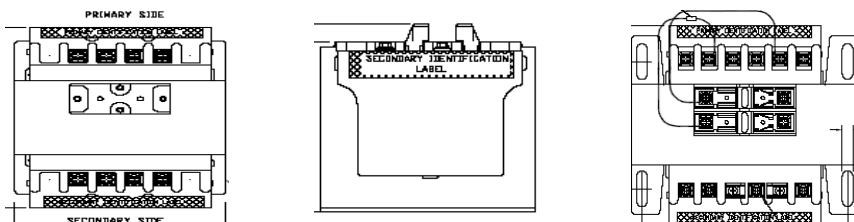

CONNECTION DIAGRAMS

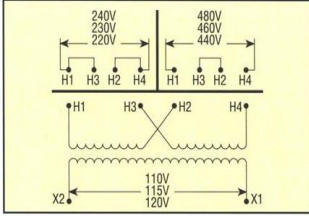

CONNECTION DIAGRAM:
GROUP "A"

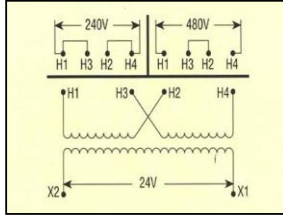

CONNECTION DIAGRAM:
GROUP "B"

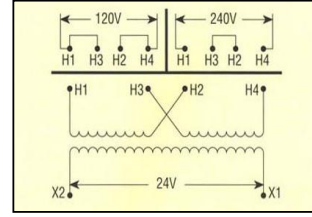

CONNECTION DIAGRAM:
GROUP "C"

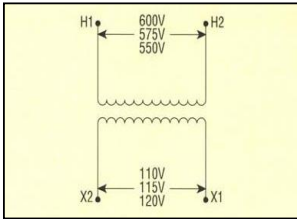

CONNECTION DIAGRAM:
GROUP "E"

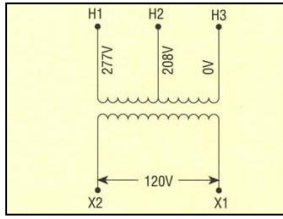

CONNECTION DIAGRAM:
GROUP "F"

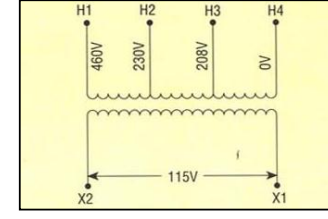

CONNECTION DIAGRAM:
GROUP "G"

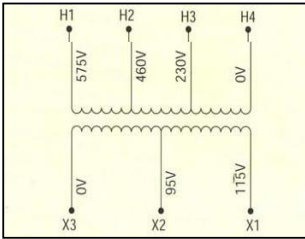

CONNECTION DIAGRAM:
GROUP "H"

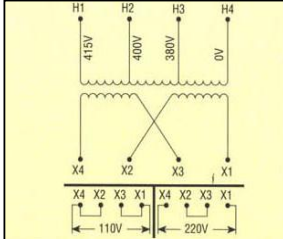

CONNECTION DIAGRAM:
GROUP "I"

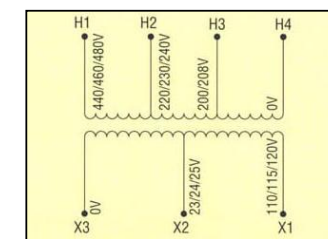

CONNECTION DIAGRAM:
GROUP "J"

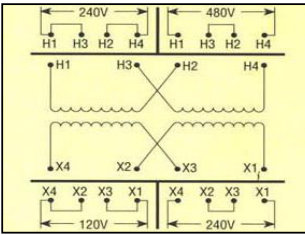

CONNECTION DIAGRAM:
GROUP "K"

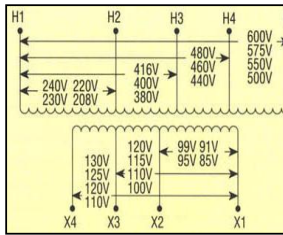

CONNECTION DIAGRAM:
GROUP "L"

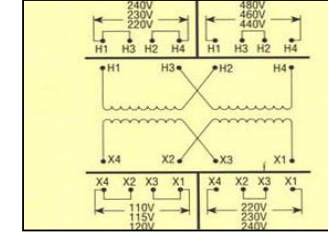

CONNECTION DIAGRAM:
GROUP "M"

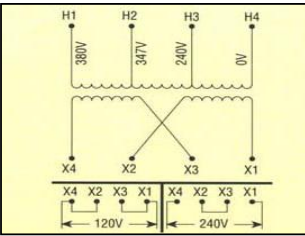

CONNECTION DIAGRAM:
GROUP "N"

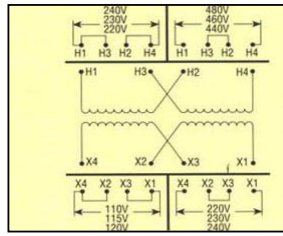

CONNECTION DIAGRAM:
GROUP "P"

CONTROL TRANSFORMER ACCESSORIES

CATALOG NUMBER		APPROX. WEIGHT	
		LBS	KG
	IP-20 SAFETOUCH™ COVERS		
TPTC-2001	10PACK 4TERM.	1.0	0.5
TPTC-2002	10PACK 6TERM.	1.0	0.5
TPTC-2006	10PACK UNIVERSAL PRI BLOCK	1.0	0.5
FKTP-1001	PRIMARY CL "CC" FUSE KIT	0.25	0.1
	OPTIONAL FACTORY INSTALLED FUSE HOLDERS		
CL. "CC" PRI.	P/N SUFFIX = RB, RK, RX, RJ, RR RY, RG, RL, RN, RC, -8 *NON-REJECTION VERSION AVAILABLE ON ALL FACTORY INSTALLED PRIMARY	N/A	
	FUSEBLOCK OPTIONS		
1/4 X 1-1/4 SEC.	P/N SUFFIX = JQ, XQ	N/A	
9/16 X 2 SEC.	P/N SUFFIX = JM, XM	N/A	
	BULK FUSE CLIPS		
514-1661-01C	(2 NECESSARY) 13/32 X 1-1/2 (STD)	N/A	
514-1661-02C	(2 NECESSARY) 1/4 X 1-1/4 (OPT)	N/A	
	BULK JUMPERS		
514-1650	J-2	N/A	
514-1652	J-3	N/A	
514-1620-02	Flat	N/A	

TRANSFORMER ACCESSORY INTERCHANGE MATRIX

STANDARD SUFFIX		DUAL PRIMARY FUSED SUFFIX
JK, JKF, JKH	>>	RB, RBF, RBH
XK, XKF, XKH	>>	RK, RKF, RKH
XX, XXF, XXH	>>	RX, RXF, RXH
XJ, XJF, XJH	>>	RJ, RJF, RJH
JJ, JJF, JJH	>>	RR, RRF, RRH
JM, JMF, JM H	>>	RY, RYF, RYH
XM, JMF, JM H	>>	RG, RGF, RGH
JQ, JQF, JQH	>>	RL, RLF, RLH
XQ, XQF, XQH	>>	RN, RNF, RNH
JX, JXF, JXH	>>	RC, RCF, RCH
-1, -1F, -1H	>>	-8, -8F, -8H

PRIMARY FUSE KIT # FKTP-1001
SERIES 2 INSTRUCTIONS ON NEXT PAGE

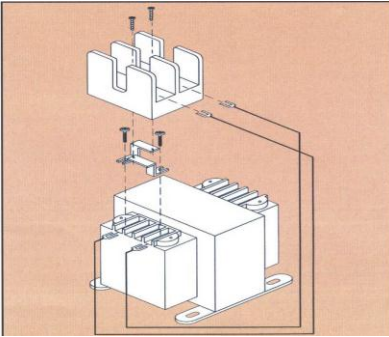

In addition to factory installed primary fusing capability Micron offers a primary fuse kit for ImperviTRAN and ValuTRAN intended for field installation. The primary fuse kit includes a 2-pole Class "CC" fuse block, instructions and all associated mounting hardware. Additionally, this fuse block will fit most competitive units. To order this kit, use catalog number **FKTP-1001**. The primary fuse kit, when installed, will add a maximum of 11/16" to the transformer "A" dimension and 1-15/16" to the "C" dimension. Installed as indicated.

1. Loosen two outer screws on primary side of transformer. On 6 position shell leave 2 spaces open between brackets.
2. Capture mounting brackets and necessary leads under terminal screws and tighten.

Recommended torque 30 in-lbs.

3. Affix fuse block to mounting bracket with supplied screws.

IP-20 COVER KIT # TPTC-2006

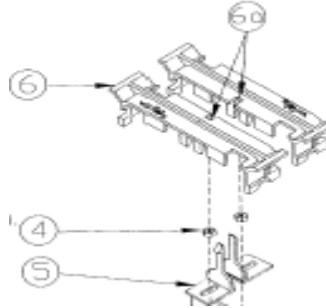

4. Remove two nuts or screws holding primary fuse block to transformer. On FKTP-1001 kits, perform step #5 prior to affixing block to brackets.
5. Install retaining clips in base of fuse block. Secure with nuts or screws as appropriate.
- 6, 6a. Install fuse in cover and snap cover in place. When installed cover cannot be removed without releasing tab from detent (6a). A tip of a pen will suffice.

GLOBALTRAN ACCESSORIES

A number of fusing accessories are available for the GlobalTRAN product line. Please contact Micron with your design requirements.

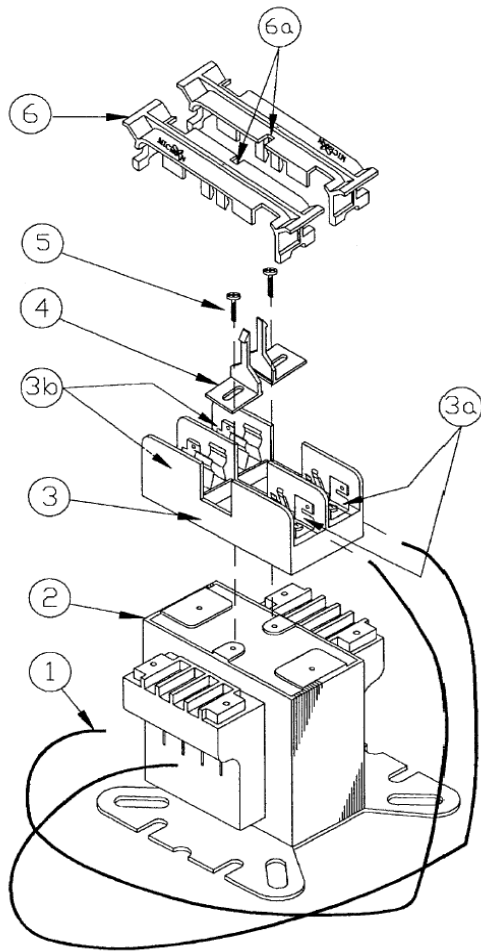

In addition to factory installed primary fusing capability Micron offers a primary fuse kit for units with integral accessory mounting plate (#2) intended for field installation on all catalog standard SERIES 2 units. The primary fuse kit includes a 2-pole Class "CC" fuse block, instructions and all associated mounting hardware. To order this kit, use catalog number **FKTP-1001**. The primary fuse kit, when installed, will add a maximum of 1-3/8" to the "C" dimension. (as measured from the top of the plate)

Installation instructions.

1. Connect one end of the 2 primary leads (#1) under the appropriate primary terminal screws. Secure screws to 16 in-lbs <500VA and 30 in-lbs 500VA and larger.
2. Insert locking clips (#4) oriented as shown into the fuse block (#3) pockets. **Use caution in choosing screw length if locking clips are not used.**
3. Attach clips and fuse block to accessory mounting plate (#2) using screws (#5). Recommended torque 16 in-lbs.
4. Insert fuses (not supplied) into fuse block followed by fuse block covers (#6) (IF ORDERED) with lock slots (#6a) matching tip of the clips, as shown. Press down until cover locks. **Refer to primary fuse chart for recommended fuses. Cover cannot be removed without releasing tab from detent (#6a). A tip of a pen will suffice.**
5. Connect the other end of the 2 primary leads (#1) under the screws on each of the 2 poles on the fuse block (#3a) and secure to 20 inch-pounds.
6. Apply primary voltage to the opposite end of the fuse block (#3b).

Additionally the mounting plate (#2) can be utilized to mount other accessories such as DIN rail. **Use caution in choosing screw length.**

SECONDARY AND PRIMARY OVERCURRENT PROTECTION

Secondary Voltage	VA RATING															
	25	50	75	100	150	200	250	300	350	500	750	1000	1500	2000	3000	5000
12	3-2/10	6-1/4	10	12	15	20	25	30	--	--	--	--	--	--	--	--
23	1-8/10	3-1/2	5	7	10	12	15	17-1/2	20	30	--	--	--	--	--	--
24	1-6/10	3-2/10	5	6-1/4	10	12	15	17-1/2	20	30	--	--	--	--	--	--
25	1-6/10	3-2/10	5	6-1/4	10	12	15	15	17-1/2	25	--	--	--	--	--	--
90	4/10	8/10	1-1/4	1-8/10	2-1/2	3-1/2	4-1/2	5	6-1/4	9	12	15	20	25	--	--
95	4/10	8/10	1-1/4	1-6/10	2-1/2	3-1/2	4	5	6	8	12	15	17-1/2	25	--	--
100	4/10	8/10	1-1/4	1-6/10	2-1/2	3-2/10	4	5	5-6/10	8	12	15	17-1/2	25	--	--
110	3/10	3/4	1-1/8	1-1/2	2-1/4	3	3-1/2	4-1/2	5	7-1/2	10	12	17-1/2	25	--	--
115	3/10	6/10	1	1-4/10	2	2-8/10	3-1/2	4	5	7	10	12	17-1/2	25	--	--
120	3/10	6/10	1	1-1/4	2	2-1/2	3-2/10	4	4-1/2	6-1/4	10	12	17-1/2	25		
220	3/16	3/10	1/2	3/4	1-1/8	1-1/2	1-8/10	2-1/4	2-1/2	3-1/2	5-6/10	7-1/2	10	12	17-1/2	30
230	15/100	3/10	1/2	6/10	1	1-4/10	1-8/10	2	2-1/2	3-1/2	5	7	10	12	17-1/2	30
240	15/100	3/10	1/2	6/10	1	1-4/10	1-6/10	2	2-1/4	3-2/10	5	6-1/4	10	12	17-1/2	30

Primary Voltage	VA RATING															
	25	50	75	100	150	200	250	300	350	500	750	1000	1500	2000	3000	5000
115	1/2	1	1-6/10	2	3-2/10	4	5	6-1/4	7-1/2	10	15	20	30	--	--	--
120	1/2	1	1-1/2	2	3	4	5	6-1/4	7	10	15	20	30	--	--	--
200	3/10	6/10	8/10	1-1/4	1-8/10	2-1/2	3	3-1/2	4	6-1/4	9	12	17-1/2	25	--	--
208	3/10	6/10	8/10	1-1/8	1-8/10	2-1/4	3	3-1/2	4	6	9	12	17-1/2	20	--	--
220	1/4	1/2	8/10	1-1/8	1-6/10	2-1/4	2-8/10	3-2/10	3-1/2	5-6/10	8	10	15	20	30	--
230	1/4	1/2	8/10	1	1-6/10	2	2-1/2	3-2/10	3-1/2	5	8	10	15	20	30	--
240	1/4	1/2	3/4	1	1-1/2	2	2-1/2	3	3-1/2	5	7-1/2	10	15	20	30	--
277	2/10	4/10	6/10	8/10	1-1/4	1-8/10	2-1/4	2-1/2	3	4-1/2	6-1/4	9	12	17-1/2	25	--
380	15/100	3/10	4/10	6/10	8/10	1-1/4	1-6/10	1-8/10	2-1/4	3-2/10	4-1/2	6-1/4	9	12	17-1/2	30
400	15/100	3/10	4/10	6/10	8/10	1-1/4	1-1/2	1-8/10	2	3	4-1/2	6-1/4	9	12	17-1/2	30
415	15/100	3/10	4/10	6/10	8/10	1-1/8	1-1/2	1-8/10	2	3	4-1/2	6	9	12	17-1/2	30
440	1/8	1/4	4/10	1/2	8/10	1-1/8	1-4/10	1-6/10	1-8/10	2-8/10	4	5-6/10	8	10	15	25
460	1/8	1/4	4/10	1/2	8/10	1	1-1/4	1-6/10	1-8/10	2-1/2	4	5	8	10	15	25
480	1/8	1/4	3/10	1/2	3/4	1	1-1/4	1-1/2	1-8/10	2-1/2	3-1/2	5	7-1/2	10	15	25
550	1/10	2/10	3/10	4/10	6/10	8/10	1-1/8	1-1/4	1-1/2	2-1/4	3-2/10	4-1/2	6-1/4	9	12	20
575	1/10	2/10	3/10	4/10	6/10	8/10	1	1-1/4	1-1/2	2	3-2/10	4	6-1/4	8	12	20
600	1/10	2/10	3/10	4/10	6/10	8/10	1	1-1/4	1-4/10	2	3	4	6-1/4	8	12	20

- If the rated secondary current is less than 9 amps, the secondary rating of overcurrent protection is 167% maximum of rated secondary current.
- If the rated secondary current is 9 amps or greater, the secondary rating of overcurrent protection is 125% maximum of rated secondary current.
- Primary rating of overcurrent protection is 250% maximum of rated primary current when secondary is protected by overcurrent protection.

Reference: NEC 450.3(B)

Rev 9/3/10

GLOBALTRAN



GlobalTRAN products carry the CE mark, certifying 100% compliance with requirements of EN61558. Additionally all GlobalTRAN products are designed to deliver the full nameplate VA rating.

Features and Benefits

Lead -free solder joints

- Provides RoHS compliant construction

Fully encapsulated coil

- Tough environment-proof construction
- Eases wire routing around the transformer

Molded terminals as an integral part of the coil

- Easily adaptable to slot and Phillips driver tools
- Robust physical support instead of “floating” terminal strips
- Both 4 and 6 terminals, or the combination, available

IP-20 level covers installed

- Meets IEC-529 protection rating

Encapsulated from 25Va through 5KVa

- Establishes product similarity throughout the product range

Full nameplate VA rating

- Eliminates guesswork

Largest standard voltage selection in the industry

- Solves “availability problem” for many OEM design-in opportunities

UL/CSA/cUL/CE Family Listing

- Absolute flexibility of special design capability for 600 volt class product

CE CONTROL TRANSFORMERS

GENERAL SPECIFICATIONS:

STYLE: IMPERVITRAN

APPROVALS: UL LISTED FILE# E46323/ CSA APPROVED FILE# LR27533, EN 61558-2-2

TEMP CLASS: 105°C/130°C/180°C

VA SIZES: 50-5000

SUFFIX DESCRIPTION:

TWO LETTER SUFFIX = TEMP CLASS 105C

THREE LETTER SUFFIX ENDING "F" = TEMP CLASS 130C

THREE LETTER SUFFIX ENDING "H" = TEMP CLASS 180C

GLOBALTRAN:

GROUP "A"

CATALOG

NUMBER

VOLTAGE:

PRI: 220x440, 230x460, 240x480

SEC: 110/115/120

	VA	AMPS
B050-2001-GA	50	0.43
B075-2002-GA	75	0.65
B100-2003-GA	100	0.87
B150-2004-GAF	150	1.30
B200-2005-GAF	200	1.74
B250-2006-GAF	250	2.17
B300-2007-GAF	300	2.61
B350-2008-GAF	350	3.04
B500-2009-GAF	500	4.35
B750-2010-GAF	750	6.52
B1K0-2008-GAH	1000	8.70
B1K5-2009-GAH	1500	13.04
B2K0-2010-GAH	2000	17.39
B3K0-2011-GAH	3000	26.09
B5K0-2012-GAH	5000	45.45

GLOBALTRAN:

GROUP "D"

CATALOG

NUMBER

VOLTAGE:

PRI: 550/575/600

SEC: 110/115/120

	VA	AMPS
B050-2041-GA	50	0.43
B075-2042-GA	75	0.65
B100-2043-GA	100	0.87
B150-2044-GAF	150	1.30
B200-2045-GAF	200	1.74
B250-2046-GAF	250	2.17
B300-2047-GAF	300	2.61
B350-2048-GAF	350	3.04
B500-2049-GAF	500	4.35
B750-2050-GAF	750	6.52

GROUP "B"

VOLTAGE:

PRI: 240x480

SEC: 24

	VA	AMPS
B050-2011-GA	50	2.08
B075-2012-GA	75	3.13
B100-2013-GA	100	4.17
B150-2014-GAF	150	6.25
B200-2015-GAF	200	8.33
B250-2016-GAF	250	10.42
B300-2017-GAF	300	12.50
B350-2018-GAF	350	14.58
B500-2019-GAF	500	20.83
B750-2020-GAF	750	31.25
B1K0-2028-GAF	1000	41.67

GROUP "E"

VOLTAGE:

PRI: 380/400/415

SEC: 110x220

	VA	AMPS
B050-2061-GA	50	.46/.23
B075-2062-GA	75	.68/.34
B100-2063-GA	100	.91/.46
B150-2064-GAF	150	1.37/.69
B200-2065-GAF	200	1.82/.91
B250-2066-GAF	250	2.28/1.14
B300-2067-GAF	300	2.72/1.36
B350-2068-GAF	350	3.18/1.59
B500-2069-GAF	500	4.55/2.27
B750-2070-GAF	750	6.82/3.41

GROUP "C"

VOLTAGE:

PRI: 120x240

SEC: 24

	VA	AMPS
B050-2021-GA	50	2.08
B075-2022-GA	75	3.13
B100-2023-GA	100	4.17
B150-2024-GAF	150	6.25
B200-2025-GAF	200	8.33
B250-2026-GAF	250	10.42
B300-2027-GAF	300	12.50
B350-2028-GAF	350	14.58
B500-2029-GAF	500	20.83
B750-2030-GAF	750	31.25
B1K0-2048-GAF	1000	41.67

GROUP "F"

VOLTAGE:

PRI: 208/230/460

SEC: 24/115

	VA	AMPS
B050-2101-GA	50	2.08/.44
B075-2102-GA	75	3.13/.65
B100-2103-GA	100	4.17/.87
B150-2104-GAF	150	6.25/1.3
B200-2105-GAF	200	8.33/1.74
B250-2106-GAF	250	10.42/2.17
B300-2107-GAF	300	12.50/2.61
B350-2108-GAF	350	14.58/3.04
B500-2109-GAF	500	20.83/4.35
B750-2110-GAF	750	31.25/6.52
B1K0-2188-GAH	1000	41.67/8.70

CE CONTROL TRANSFORMERS

**GLOBALTRAN:
GROUP "G"
CATALOG
NUMBER**

VOLTAGE:
PRI: 380
SEC: 24

	VA	AMPS
B050-2051-GA	50	2.08
B075-2052-GA	75	3.13
B100-2053-GA	100	4.17
B150-2054-GAF	150	6.25
B200-2055-GAF	200	8.33
B250-2056-GAF	250	10.42
B300-2057-GAF	300	12.50
B350-2058-GAF	350	14.58
B500-2059-GAF	500	20.83
B750-2060-GAF	750	31.25

**GLOBALTRAN:
GROUP "I"
CATALOG
NUMBER**

VOLTAGE:
PRI: 208/230/400/460/575
SEC: 24*/115/230

	VA	AMPS
B250-2263-GAF	250	10.4/2.2/1.1
B300-2264-GAF	300	12.5/2.6/1.3
B350-2265-GAF	350	14.6/3.0/1.5
B500-2266-GAF	500	20.8/4.3/2.2
B750-2267-GAF	750	31.3/6.5/3.3
B1K0-2268-GAH	1000	41.7/8.7/4.3
B1K5-2269-GAH	1500	13.04/6.52
B2K0-2270-GAH	2000	17.39/8.70
B3K0-2271-GAH	3000	26.09/13.04
B5K0-2272-GAH	5000	43.48/21.74

* 24 AVAILABLE THROUGH 1Kva

GROUP "H"

VOLTAGE:
PRI: 208-600
SEC: 85-130

	VA	AMPS
B250-2283-GAF	250	1.92
B300-2284-GAF	300	2.31
B350-2285-GAF	350	2.69
B500-2286-GAF	500	3.85
B750-2287-GAF	750	5.77
B1K0-2288-GAH	1000	7.69
B1K5-2289-GAH	1500	11.54
B2K0-2290-GAH	2000	15.38
B3K0-2291-GAH	3000	23.08

GROUP "J"

VOLTAGE:
PRI: 230/400/460/575
SEC: 24/115

	VA	AMPS
B250-2243-GAF	250	10.4/2.2
B300-2244-GAF	300	12.5/2.6
B350-2245-GAF	350	14.6/3.0
B500-2246-GAF	500	20.8/4.3
B750-2247-GAF	750	31.3/6.5
B1K0-2248-GAH	1000	41.7/8.7

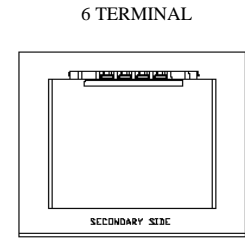
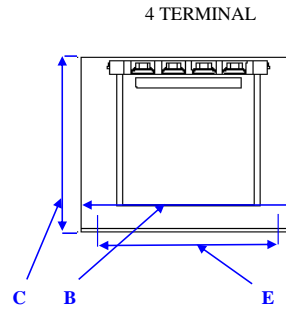
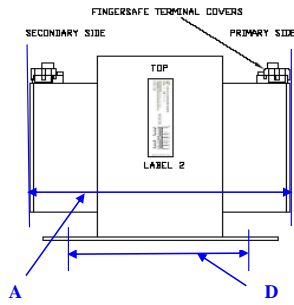

CATALOG GROUPS

P/N	A		B		C		D		E		APPROX WEIGHT LBS
	IN	MM	IN	MM	IN	MM	IN	MM	IN	MM	
A											
B050-2001-GA	3.38	86	3.00	76	3.00	76	2.44	61	2.50	64	3.4
B075-2002-GA	3.38	86	3.38	86	3.25	83	2.44	61	2.81	71	4.8
B100-2003-GA	3.38	86	3.75	95	3.50	89	2.44	61	3.13	79	5.9
B150-2004-GAF	3.75	95	4.50	114	4.00	102	2.44	61	3.75	95	8.5
B200-2005-GAF	3.75	95	4.50	114	4.00	102	2.81	71	3.75	95	10.0
B250-2006-GAF	4.00	102	4.50	114	4.00	102	3.19	81	3.75	95	11.0
B300-2007-GAF	4.38	111	4.50	114	4.00	102	3.75	95	3.75	95	13.0
B350-2008-GAF	4.88	124	5.25	133	4.50	114	3.38	86	4.38	111	15.0
B500-2009-GAF	5.13	130	5.25	133	4.50	114	4.38	111	4.38	111	20.0
B750-2010-GAF	7.00	178	5.25	133	4.50	114	5.88	149	4.38	111	29.8
B1K0-2008-GAH	6.63	168	6.38	162	5.50	140	3.75	95	5.31	135	35.0
B1K5-2009-GAH	7.31	186	6.75	172	6.00	152	5.00	127	6.13	156	40.0
B2K0-2010-GAH	8.13	203	6.75	172	6.00	152	5.25	133	6.13	156	45.0
B3K0-2011-GAH	8.06	202	9.00	225	8.00	200	5.25	133	7.50	191	65.2
B5K0-2012-GAH	10.00	250	9.00	225	8.00	200	7.19	183	7.50	191	104.8
B											
B050-2011-GA	3.38	86	3.00	76	3.00	76	2.19	56	2.50	64	3.4
B075-2012-GA	3.38	86	3.38	86	3.25	83	2.19	56	2.81	71	4.2
B100-2013-GA	3.38	86	3.75	95	3.50	89	2.44	61	3.13	80	5.9
B150-2014-GAF	4.00	102	4.50	114	4.00	102	2.44	62	3.75	95	8.5
B200-2015-GAF	3.75	95	4.50	114	4.00	102	2.81	71	3.75	95	10.0
B250-2016-GAF	4.00	102	4.50	114	4.00	102	3.19	81	3.75	95	11.0
B300-2017-GAF	4.38	111	4.50	114	4.00	102	3.75	95	3.75	95	13.2
B350-2018-GAF	4.50	114	5.25	133	4.50	114	3.38	86	4.38	111	14.9
B500-2019-GAF	5.13	130	5.25	133	4.50	114	3.88	99	4.38	111	19.2
B750-2020-GAF	7.00	178	5.25	133	5.00	127	5.38	137	4.38	111	28.1
B1K0-2028-GAF	7.00	178	6.38	162	6.00	152	3.75	95	5.31	135	30.0
C											
B050-2021-GA	3.38	86	3.00	76	3.00	76	2.19	55	2.50	64	3.4
B075-2022-GA	3.38	86	3.38	86	3.25	83	2.19	56	2.81	71	4.2
B100-2023-GA	3.38	86	3.75	95	3.50	89	2.44	61	3.13	79	5.9
B150-2024-GAF	3.75	95	4.50	114	4.00	102	2.44	61	3.75	95	8.5
B200-2025-GAF	3.75	95	4.50	114	4.00	102	2.81	70	3.75	95	10.0
B250-2026-GAF	4.00	102	4.50	114	4.00	102	3.19	81	3.75	95	11.0
B300-2027-GAF	4.38	111	4.50	114	4.00	102	3.75	95	3.75	95	13.2
B350-2028-GAF	4.50	114	5.25	133	4.50	114	3.38	86	4.38	111	14.9
B500-2029-GAF	5.13	130	5.25	133	4.50	114	3.88	99	4.38	111	19.2
B750-2030-GAF	7.00	178	5.25	133	4.50	114	5.88	149	4.38	111	29.8
B1K0-2048-GAF	7.00	178	6.38	162	6.00	152	3.75	95	5.31	135	31.0
D											
B050-2041-GA	3.38	86	3.00	76	3.00	76	2.44	61	2.50	64	3.4
B075-2042-GA	3.38	86	3.38	86	3.25	83	2.44	61	2.81	71	4.8
B100-2043-GA	3.38	86	3.75	95	3.50	89	2.44	61	3.13	80	5.9
B150-2044-GAF	3.75	95	4.50	114	4.00	102	2.44	61	3.75	95	8.5
B200-2045-GAF	3.75	95	4.50	114	4.00	102	3.00	76	3.75	95	10.0
B250-2046-GAF	4.00	102	4.50	114	4.00	102	3.19	81	3.75	95	11.0
B300-2047-GAF	4.38	111	4.50	114	4.00	102	3.75	95	3.75	95	13.0
B350-2048-GAF	4.50	114	5.25	133	4.50	114	3.38	86	4.38	111	15.0
B500-2049-GAF	5.13	130	5.25	133	4.50	114	4.38	111	4.38	111	20.0
B750-2050-GAF	7.00	178	5.25	133	4.50	114	5.38	137	4.38	111	28.0

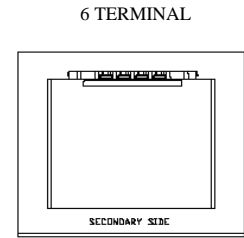
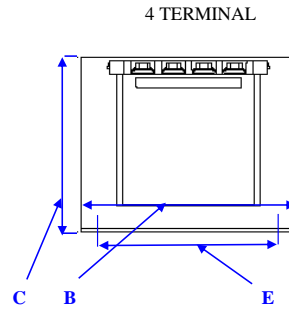
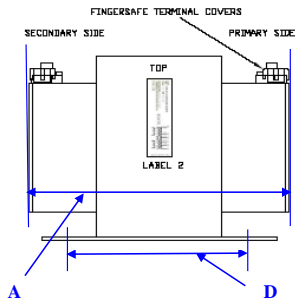

CATALOG GROUPS

DIMENSIONS INCHES (MM)

APPROX WEIGHT

P/N	A		B		C		D		E		LBS
	IN	MM	IN	MM	IN	MM	IN	MM	IN	MM	
E											
B050-2061-GA	3.38	86	3.00	76	3.00	76	2.44	61	2.50	64	3.4
B075-2062-GA	3.38	86	3.38	86	3.50	89	2.44	61	2.81	71	4.8
B100-2063-GA	3.38	86	3.75	95	3.50	89	2.44	61	3.13	79	5.9
B150-2064-GAF	3.75	95	4.50	114	4.00	102	2.44	61	3.75	95	8.5
B200-2065-GAF	3.75	95	4.50	114	4.00	102	3.00	76	3.75	95	10.0
B250-2066-GAF	4.00	102	4.50	114	4.00	102	3.19	81	3.75	95	11.0
B300-2067-GAF	4.38	111	4.50	114	4.00	102	3.75	95	3.75	95	13.0
B350-2068-GAF	4.75	121	4.50	114	4.00	102	3.75	95	3.75	95	15.0
B500-2069-GAF	5.13	130	5.25	133	4.50	114	4.38	111	4.38	111	20.0
B750-2070-GAF	7.00	178	5.25	133	4.50	114	5.88	149	4.38	111	27.0
F											
B050-2101-GA	3.38	86	3.00	76	3.25	83	2.25	56	2.81	71	4.2
B075-2102-GA	3.38	86	3.38	86	3.50	89	2.44	61	3.13	79	5.9
B100-2103-GA	3.63	92	3.75	95	3.50	89	3.19	81	3.13	79	7.9
B150-2104-GAF	3.75	95	4.50	114	4.00	102	2.81	71	3.75	95	10.0
B200-2105-GAF	4.38	111	4.50	114	4.00	102	3.44	87	3.75	95	12.8
B250-2106-GAF	4.75	121	4.50	114	4.00	102	3.75	95	3.75	95	14.0
B300-2107-GAF	4.88	124	5.25	133	4.50	114	3.88	99	4.38	111	16.8
B350-2108-GAF	4.88	124	5.25	133	4.50	114	3.88	99	4.38	111	19.2
B500-2109-GAF	5.63	143	5.25	133	4.50	114	5.88	149	4.38	111	29
B750-2110-GAF	6.63	168	6.38	162	6.00	152	5.06	129	5.31	111	29.8
B1K0-2188-GAH	7.06	179	6.38	162	6.00	152	5.06	129	5.31	135	30.2
G											
B050-2051-GA	3.38	86	3.00	76	3.00	76	2.19	55	2.50	64	3.5
B075-2052-GA	3.38	86	3.38	86	3.25	83	2.19	56	2.81	71	4.2
B100-2053-GA	3.38	86	3.75	95	3.50	89	2.44	61	3.13	79	5.9
B150-2054-GAF	3.63	91	3.75	95	3.50	89	3.00	61	3.13	79	
B200-2055-GAF	3.75	95	4.50	114	4.00	102	2.81	70	3.75	95	9.6
B250-2056-GAF	4.00	102	4.50	114	4.00	102	3.19	81	3.75	95	11.3
B300-2057-GAF	4.38	111	4.50	114	4.00	102	3.75	95	3.75	95	13.2
B350-2058-GAF	4.50	114	5.25	133	4.50	114	3.88	99	4.38	111	14.9
B500-2059-GAF	5.13	130	5.25	133	4.50	114	3.88	99	4.38	111	19.2
B750-2060-GAF	7.00	178	5.25	133	4.50	114	5.88	149	4.38	111	29.8
H											
B250-2283-GAF	4.25	108	4.50	114	4.00	102	3.44	86	3.75	95	11.4
B300-2284-GAF	4.75	121	4.50	114	4.00	102	3.75	95	3.75	95	13.6
B350-2285-GAF	5.00	127	4.50	114	4.00	102	3.75	95	3.75	95	14.2
B500-2286-GAF	5.50	140	5.25	133	4.25	108	3.88	99	4.38	111	17.4
B750-2287-GAF	7.38	187	5.25	133	4.50	114	5.88	149	4.38	111	27.5
B1K0-2288-GAH	7.00	178	6.38	162	5.50	140	5.06	129	5.31	135	27.9
B1K5-2289-GAH	7.75	199	6.75	171	6.00	152	5.00	127	6.13	156	43.1
B2K0-2290-GAH	7.63	194	9.00	229	8.00	203	4.81	122	7.50	191	56.0
B3K0-2291-GAH	8.56	217	9.00	229	7.63	194	5.75	146	7.50	191	76.2

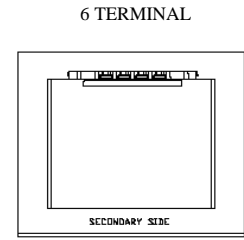
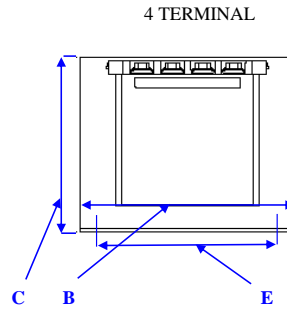
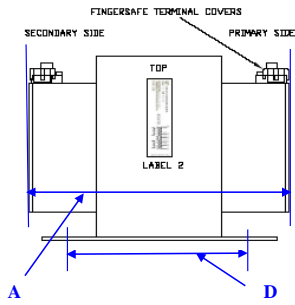

CATALOG GROUPS

P/N	A		B		C		D		E		APPROX WEIGHT LBS
	IN	MM	IN	MM	IN	MM	IN	MM	IN	MM	
I											
B250-2263-GAF	4.75	121	4.50	114	4.00	102	4.75	121	3.75	95	14.9
B300-2264-GAF	5.25	133	4.50	114	4.00	102	4.75	121	3.75	95	17.4
B350-2265-GAF	5.38	137	5.25	133	4.50	114	4.38	111	4.38	111	17.8
B500-2266-GAF	5.63	168	5.25	133	4.50	114	5.88	149	4.38	111	26.6
B750-2267-GAF	7.44	189	6.38	162	6.00	152	5.06	129	5.31	135	32.5
B1K0-2268-GAH	7.75	199	6.75	171	6.25	159	5.00	127	6.13	156	44.0
B1K5-2269-GAH	7.75	199	6.75	171	6.00	152	5.00	127	6.13	156	45.4
B2K0-2270-GAH	7.63	194	9.00	229	7.63	194	4.81	122	7.50	191	58.6
B3K0-2271-GAH	8.75	222	9.00	229	7.63	194	5.94	151	7.50	191	92.9
B5K0-2272-GAH	10.44	265	9.00	229	7.63	194	7.63	194	7.50	191	127.4
J											
B250-2243-GAF	4.75	121	4.50	114	4.00	102	3.75	95	3.75	95	14.3
B300-2244-GAF	5.00	127	4.50	114	4.00	102	4.75	121	3.75	95	15.8
B350-2245-GAF	5.13	130	5.25	133	4.50	114	3.88	99	4.38	111	16.5
B500-2246-GAF	5.75	146	5.25	133	4.50	114	4.88	124	4.38	111	20.5
B750-2247-GAF	7.00	178	6.38	162	6.00	152	5.06	129	5.31	135	28.8
B1K0-2248-GAH	8.13	207	6.38	162	6.00	152	5.06	129	5.31	135	34.9

CONNECTION DIAGRAMS - GLOBALTRAN

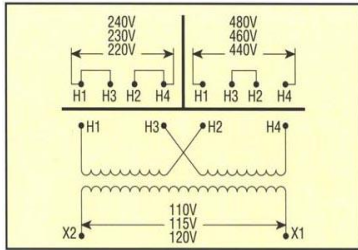

CONNECTION DIAGRAM:
GROUP "A"

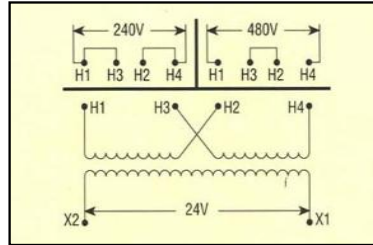

CONNECTION DIAGRAM:
GROUP "B"

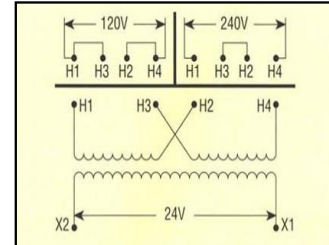

CONNECTION DIAGRAM:
GROUP "C"

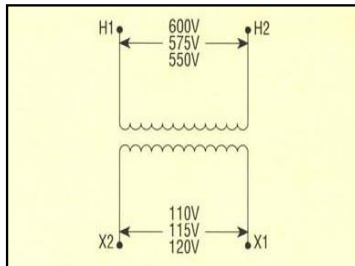

CONNECTION DIAGRAM:
GROUP "D"

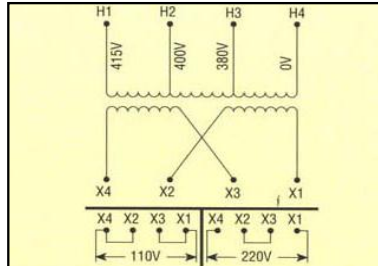

CONNECTION DIAGRAM:
GROUP "E"

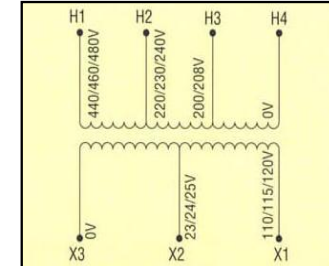

CONNECTION DIAGRAM:
GROUP "F"

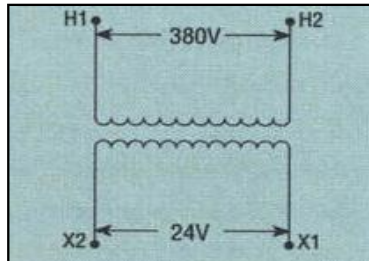

CONNECTION DIAGRAM:
GROUP "G"

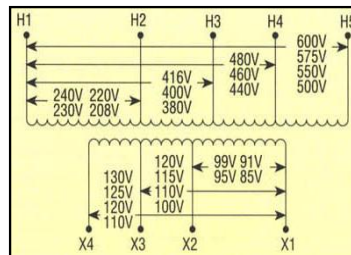

CONNECTION DIAGRAM:
GROUP "H"

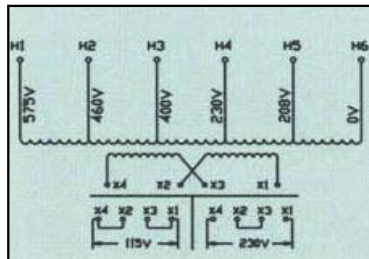

CONNECTION DIAGRAM:
GROUP "I"
Above 1 Kva

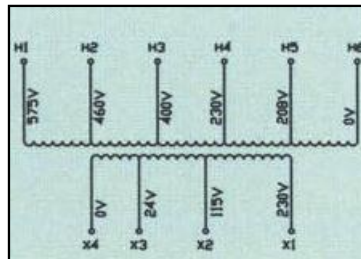

CONNECTION DIAGRAM:
GROUP "I"
Through 1 Kva

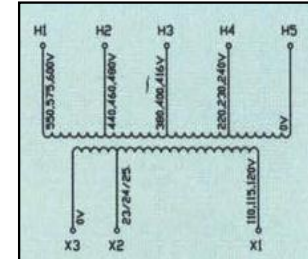

CONNECTION DIAGRAM:
GROUP "J"

MEDIUM VOLTAGE CONTROL TRANSFORMERS

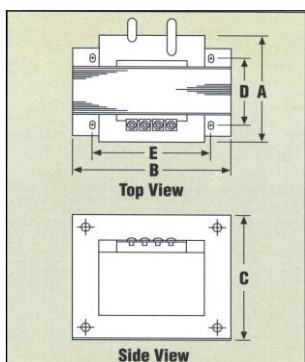

Micron medium voltage control transformers have:

- * 130° C Insulation system.
- * 24" Minimum primary lead length.
- * 60Hz.
- * HIPOT - 7,400 volts for 2400 primary.
- * HIPOT - 11,500 volts for 4160 and 2400 primaries.
- * 750 VA - Epoxy impregnated coils.
- * 1 KVA and larger - Epoxy potted primary coils.

DIMENSIONS

CONTROL TRANSFORMERS: CATALOG NUMBER	MEDIUM VOLTAGE OUTPUT		DIMENSIONS INCHES (MM)								APPROX. WEIGHT LBS			
	VA	AMPS	A		B		C		D			E		
VOLTAGE:			IN	MM	IN	MM	IN	MM	IN	MM	IN	MM		
*PRI: 4200 PRI: 2400 SEC: 120														
H750-0030	*	750	6.25	6.63	168	6.38	162	5.81	148	5.25	133	5.31	135	30.5
H750-0031		750	6.25	6.63	168	6.38	162	5.81	148	5.25	133	5.31	135	30.7
*PRI: 4160 PRI: 2400 SEC: 120/240														
H1K0-0010		1000	8.33/4.17	6.25	159	7.56	192	6.38	162	3.50	89	5.63	143	31.3
H1K0-0015	*	1000	8.33/4.17	6.25	159	7.56	192	6.38	162	3.50	89	5.63	143	31.1
HN1K5F1519P		1500	12.50/6.25	7.00	178	9.00	229	7.63	194	4.25	108	6.50	165	53.7
HN1K5G1519P	*	1500	12.50/6.25	7.00	178	9.00	229	7.63	194	4.25	108	6.50	165	52.2
HN2K0F1519P		2000	16.67/8.33	7.94	202	9.00	229	7.63	194	5.19	132	6.50	165	65.4
HN2K0G1519P	*	2000	16.67/8.33	7.94	202	9.00	229	7.63	194	5.19	132	6.50	165	58.2
HN3K0F1519P		3000	25.00/12.50	9.75	248	9.00	229	7.63	194	7.00	178	6.50	165	99.9
HN3K0G1519P	*	3000	25.00/12.50	9.75	248	9.00	229	7.63	194	7.00	178	6.50	165	101.0

DINergy™ Industrial DIN Rail Power Supplies



Micron DINergy™ Power Supply Selection Guide

Model	Output Power (Watts)	Output Voltage (VDC)	Voltage Adj. Range	Output Current (A)	Peak Current (A)	Input Voltage (VAC)	Size WxDxH(mm)
MDP30-24-1	30	24	22 - 28	1.25	1.70	90-255	22.5X100X90
MDP30-15-1	30	15	14 - 18	2.0	2.70	90-255	22.5X100X90
MDP30-12-1	30	12	10 - 14	2.5	3.40	90-255	22.5X100X90
MDP30-5-1	30	5	4.5 - 5.5	4.0	5.40	90-255	22.5X100X90
MDP50-24-1	50	24	22 - 28	2.27 - 1.79	3.09	90-255	32X102X90
MDP50-12-1	50	12	10 - 14	5.0 - 3.57	6.80	90-255	32X102X90
MD60-24-1	60	24	22 - 28	2.5	3.0	85-264	50x105x124
MD60-12-1	54	12	10 - 16	4.5	5.4	85-264	50x105x124
MD60-48-1	60	48	46 - 52	1.3	1.5	85-264	50x105x124
MD120-24-1	120	24	22 - 28	5.0	6.0	85-264	65x105x124
MD120-12-1	96	12	10 - 16	8.0	9.6	85-264	65x105x124
MD120-48-1	120	48	46 - 52	2.5	3.0	85-264	65x105x124
MD240-24-1	240	24	22 - 28	10.0	12.0	85-264	87x124x130
MD240-12-1	180	12	11 - 14	15.0	18.0	85-264	87x124x130
MD240-48-1	240	48	46 - 52	5.0	6.0	85-264	87x124x130
MD480-24-1	480	24	22 - 28	20.0	24.0	85-264	156x126x130
MD480-36-1	480	36	34 - 40	13.0	16.0	85-264	156x126x130
MD480-24-1	480	48	46 - 52	10.0	12.0	85-264	156x126x130
MD-PDMA	480	24	N/A	20.0 MAX	24.0 MAX	85-264	50x105x124
REDUNDANCY DIODE MODULE							
MD-VSB240-24-1	240	24	N/A	10.0	N/A	24VDC	76X116X130
VOLTAGE SAG BUFFER		+/-10%				+/-5%	
MD-LAB-DINBRKTA	N/A	24	N/A	3.4AH/20HF	N/A	N/A	145X77X143
MD-LAB-DINBRKTE	N/A	24	N/A	1.3AH/20HF	N/A	N/A	95X81X105
MD-DINBRKTA	BRACKET ASSEMBLY FOR 3.4AH SLA						145X77X143
MD-DINBRKTB	BRACKET ASSEMBLY FOR 1.3AH SLA						95X81X105

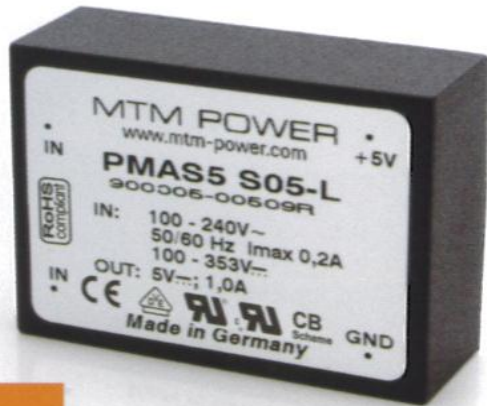

PMA, PCMA, PMA5, PCMA5, PMN & PCMN encapsulated designs feature reduced stand-by power consumption and are available in various power ranges from 5 watts – 100 watts. The primary voltage range of 90 -264 Vac / 100 -353 Vdc with available single, dual or triple output voltages makes these the logical choice for PCB and chassis mount applications in otherwise hostile environments.

The PCMA5C power supply has been specifically designed to operate at -55°C and is available at a power rating of 100 watts @ 24Vdc.



PCMed / PCMed encapsulated designs for medical applications are available in power ranges of from 15 watts – 100 watts. The primary voltage range of 90 -264 Vac / 100 -353 Vdc with single output selections for PCB and chassis mount applications where EN/UL 60 601-1/EN/UL 60 950-1 (2nd Edition) is necessary.

Protected from vibration and the environment, the HMA, HMG, HMN, encapsulated DIN-Mount designs are available in power ranges of 15 and 30 watts with single, dual or triple output voltages. The HSA design is available through 120 watts with choices of multiple outputs through 48Vdc. The HSAC variant is certified to operate at -55°C as well.

The HSD product is a DC/DC DIN-Mount device in power ratings of 15 and 30 watts.

...MTM Power DC/DC converters for vehicles and industrial applications...



... For rugged vehicular or industrial applications, MTM Power DC/DC converters are available as a standard with single dual or triple outputs in various power ranges and if required as customized devices. Featuring isolation up to 4 kVac and available in metal or plastic case.

PMG/PCMG encapsulated DC/DC designs are available in power ratings of 15 and 30 watts and with up to three output voltages.

PMD/PCMD encapsulated DC/DC designs through 400 watts or the **PCMDS** (space saving) through 650 watts for vehicular applications.

PMD encapsulated DC/DC designs for industrial applications with power ratings from 1 watt – 350 watts.



as utiliz
ts. PM

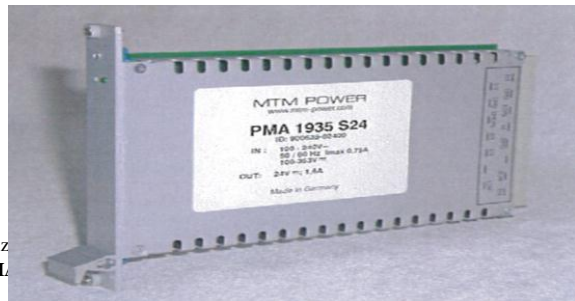

DRY TYPE TRANSFORMERS GENERAL INFORMATION



**Single Phase
Type 1-E Encapsulated**

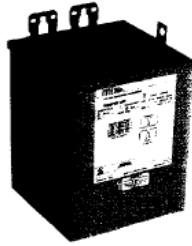

**Three Phase
Type 3-E Encapsulated**

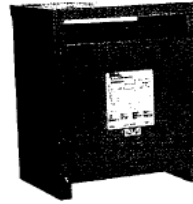

**Single Phase
Type 1-V Ventilated**

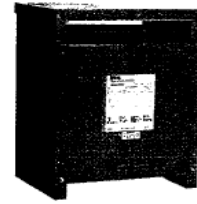

**Three Phase
Type 3-V Ventilated**

Type 1-E general purpose transformers are single phase, resin encapsulated designs suitable for indoor or outdoor applications. Its totally-enclosed, non-ventilated enclosure make it ideally suited for use in areas that contain dust, moisture, or corrosive fumes. Available in ratings through 25 kVA type 1-E transformers can be mounted in any position for indoor installations and in upright positions only for outdoor installations.

Type 3-E resin encapsulated, 3-phase transformers are available in ratings of 3-75 kVA. Its totally enclosed non-ventilated enclosure makes the 3-E ideally suited for outdoor as well as indoor locations. Type 3-E transformers utilize the 185°C insulation system with 115°C rise. 3-E transformers 3-15 kVA are T-T connected.

Units installed outdoors must be mounted in upright position.

1-V general purpose transformers are single phase ventilated units designed primarily for indoor locations (also for outdoor for 600 volt class with the addition of weathershields). The 1-V utilizes a 220°C insulation system with 150°C. rise and is available in ratings of 15-167 kVA.

The 3-phase 3-V ventilated dry-type is available in ratings of 15-750 kVA. Its 220°C insulation system (150°C. rise) is self-extinguishing. 3-V enclosures are designed for indoor locations (or outdoors for 600 volt class with addition of weathershields).

General Information

Industry Standards

All Micron dry-type distribution and control transformers are built and tested in accordance with applicable NEMA, ANSI and IEEE standards. All 600 volt class transformers are UL listed unless otherwise noted.

Seismic Qualified

The Micron family of dry-type distribution transformers is seismically tested, seismically qualified and exceeds requirements of the Uniform Building Code (UBC) and California Code Title 24.

Frequency

Micron standard dry-type distribution transformers are designed for 60 Hertz operation. Transformers required for other frequencies must be specifically designed.

Overload Capability

Short term overload is designed into transformers as required by ANSI. Basically, dry-type distribution transformers will deliver 200% nameplate load for one-half hour; 150% load for one-hour; and 125% load for four-hours without being damaged provided that a constant 50% load precedes and follows the overload. See ANSI C57.96-01.250 for additional limitations.

Continuous overload capacity is not deliberately designed into a transformer because the design objective is to be within the allowed winding temperature rise with nameplate loading.

Insulation System & Temperature Rise

Industry standards classify insulation systems and rise as shown below:

Insulation System Classification

Ambient	+ Winding Rise	+ Hot Spot	= Temp. Class
40°C	65°C	10°C	105°C
40°C	80°C	30°C	150°C
40°C	115°C	30°C	185°C

The following pages provide listings for standard transformer ratings and styles.
For other ratings or styles not shown, or for special enclosure types (including stainless steel) contact Micron.

① Applies to general purpose transformers only.

The design life of transformers having different insulation systems is the same — the lower temperature systems are designed for the same life as the higher temperature systems.

Sound Levels

All Micron 600 volt class dry-type distribution transformers are designed to meet NEMA ST-20 levels listed here.

kVA	NEMA Average ^① Sound Level in dB ^a
0 - 9	40
10 - 50	45

Winding Terminations

Primary and secondary windings are terminated in the wiring compartment. Encapsulated units have copper leads or stabs brought out for connections. Micron recommends external cables be rated 90°C (sized at 75°C ampacity) for encapsulated designs.

Series-Multiple Windings

Series-multiple windings consist of 2 similar coils in each winding which can be connected in series or parallel (multiple). Transformers with series-multiple windings are designated with an "X" or "/" between the voltage ratings, such as primary voltage of "120/240" or "240 X 480". If the series-multiple winding is designated by an "X", the winding can be connected *only* for a series or parallel. With the "/" designation, a mid-point also becomes available in addition to the series or parallel connection. As an example, a 120 X 240 winding can be connected for either 120 (parallel) or 240 (series), but a 120/240 winding can be connected for 120 (parallel), or 240 (series), or 240 with a 120 mid-point.

Micron can provide a general purpose or buck-boost transformer to satisfy your industrial or commercial application. Please refer to Catalog number LVGP-09A for further information

NOTES:



Micron Industries Corporation

Oak Brook, IL 60523

Phone: 800-664-4660

FAX: 630-516-1820

www.micronpower.com